

1

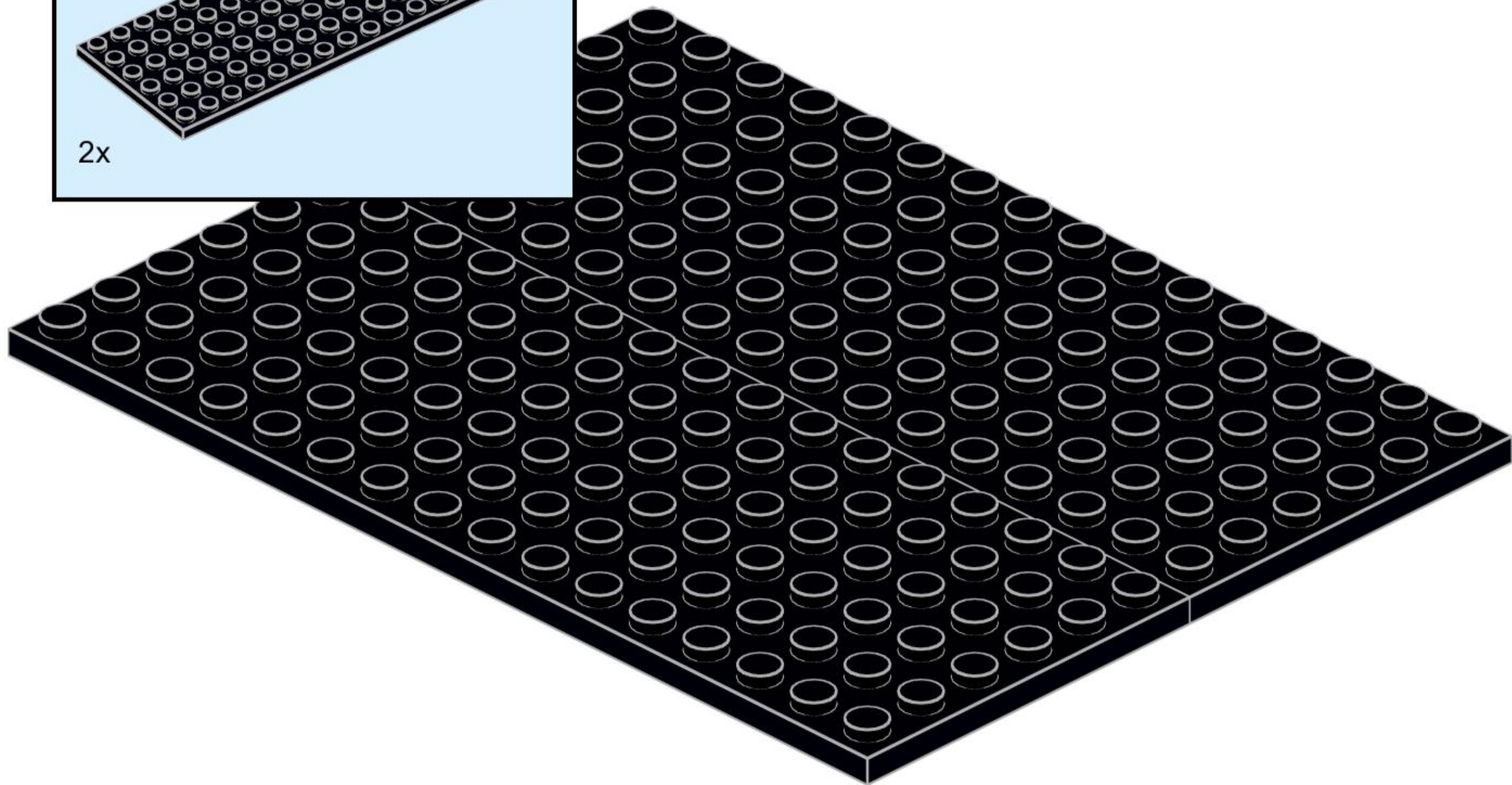

2

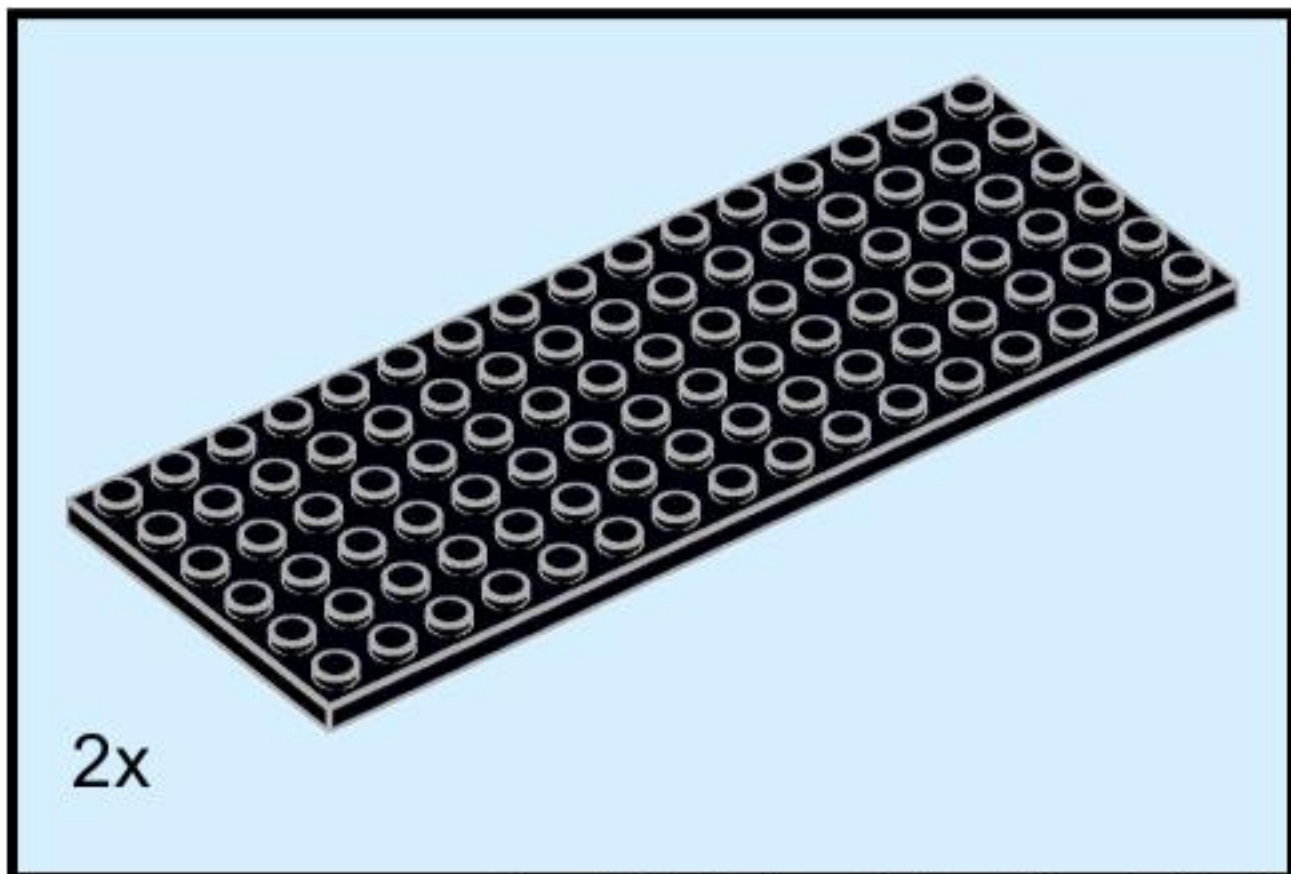
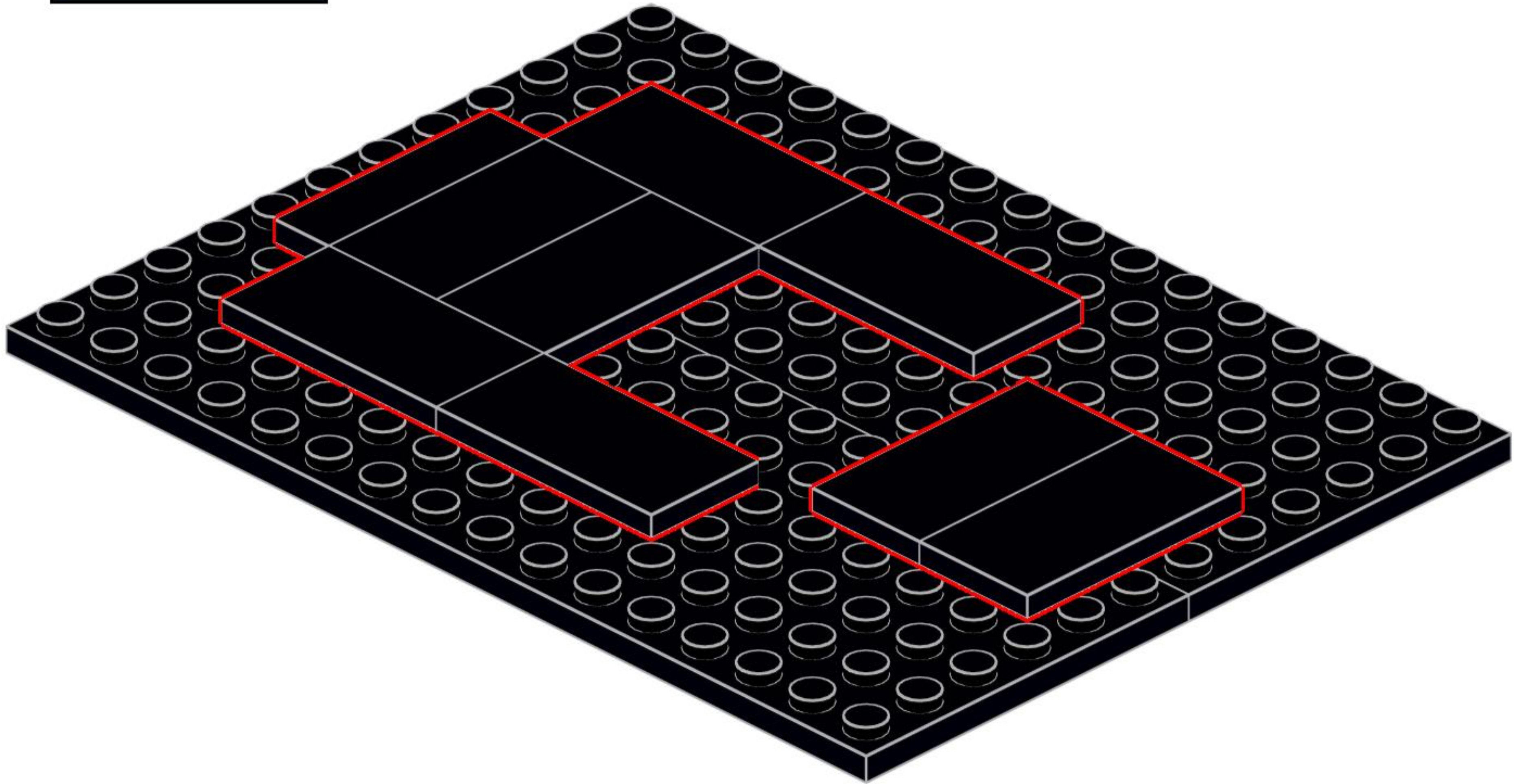
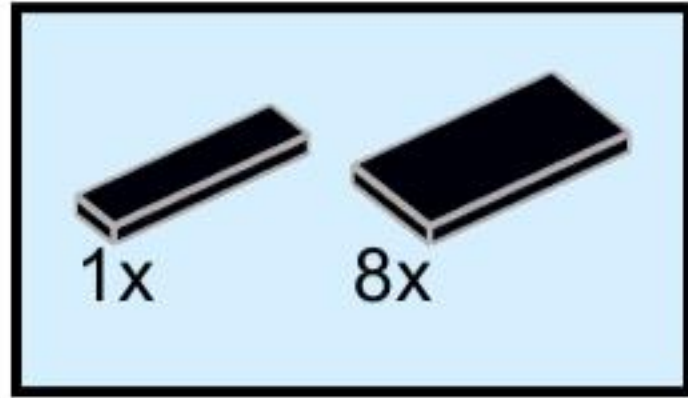

3

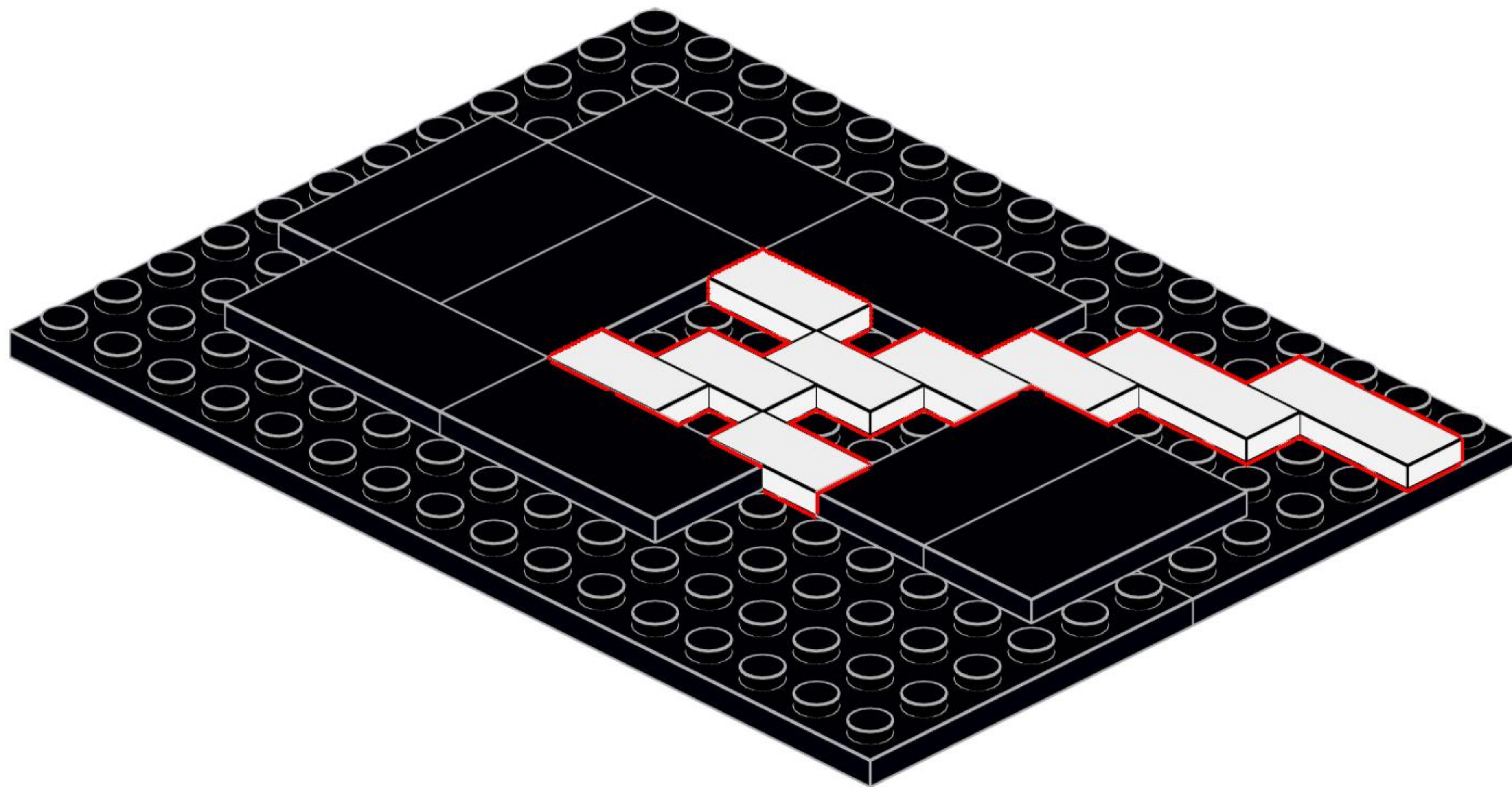
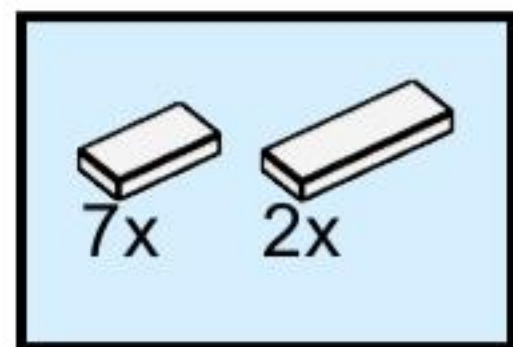

4

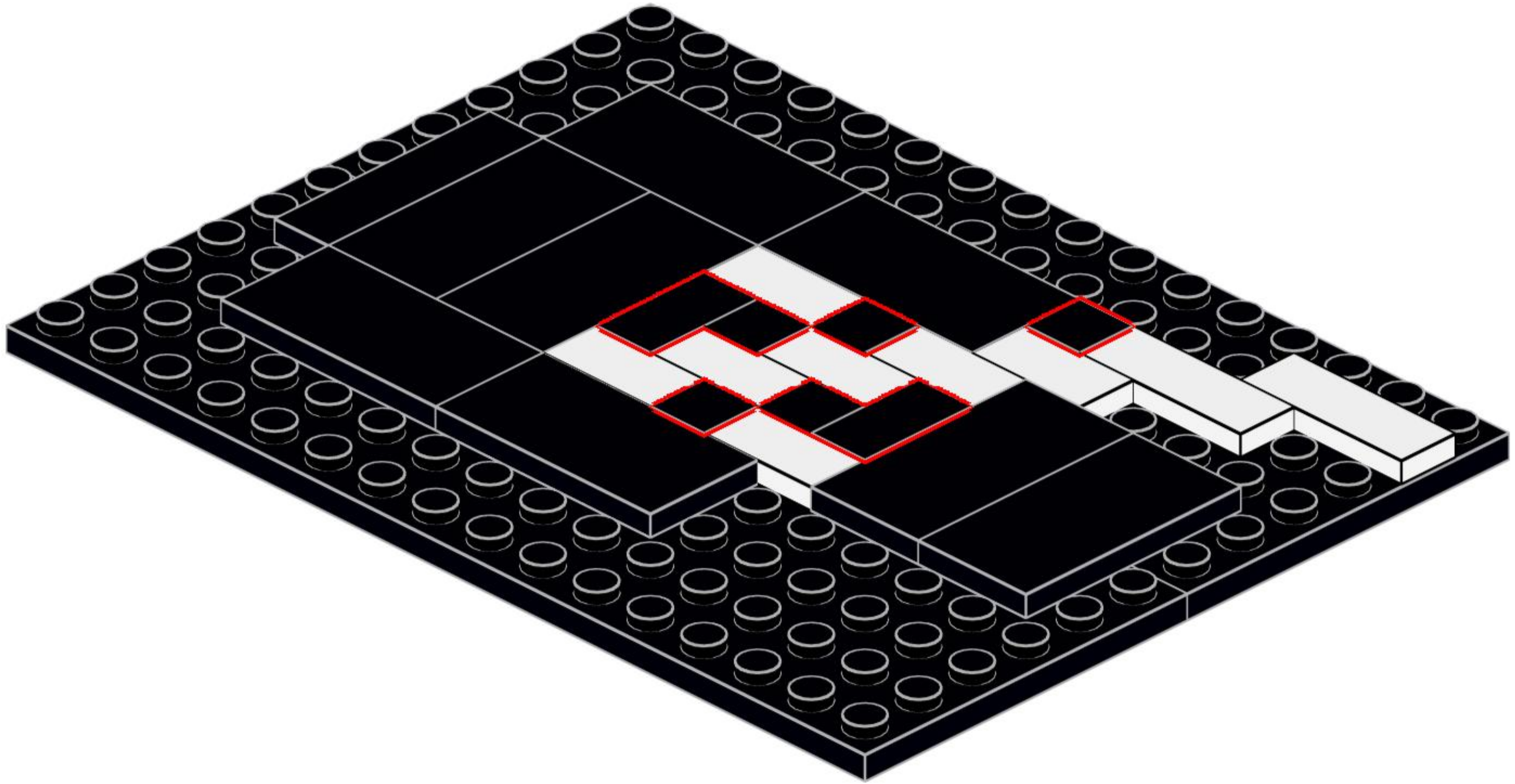
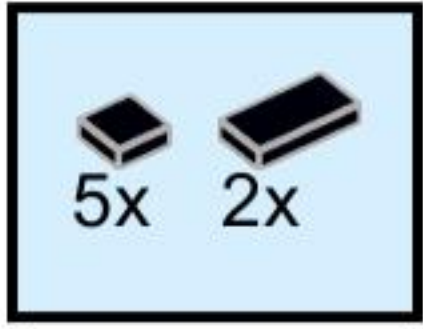

5

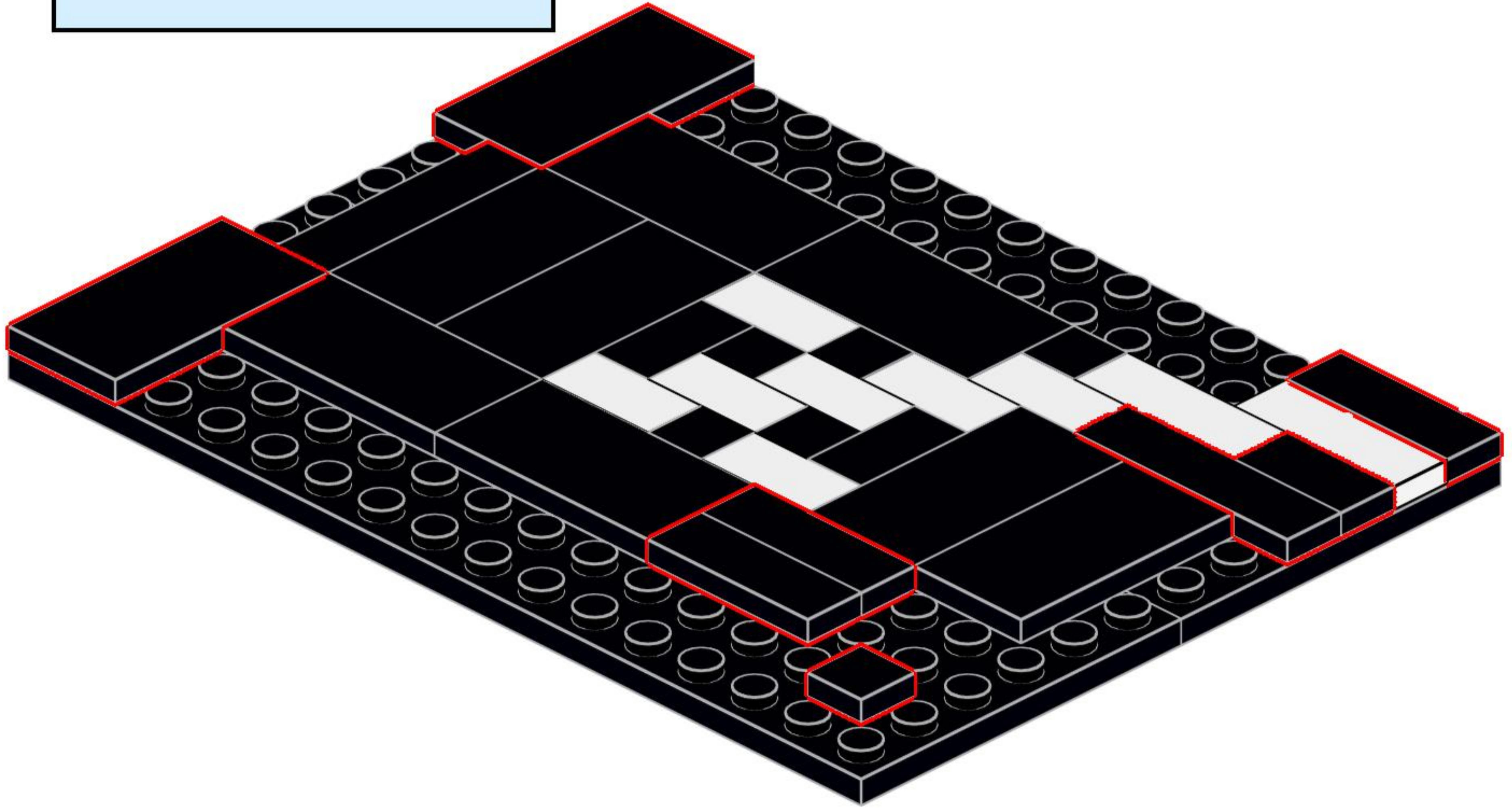
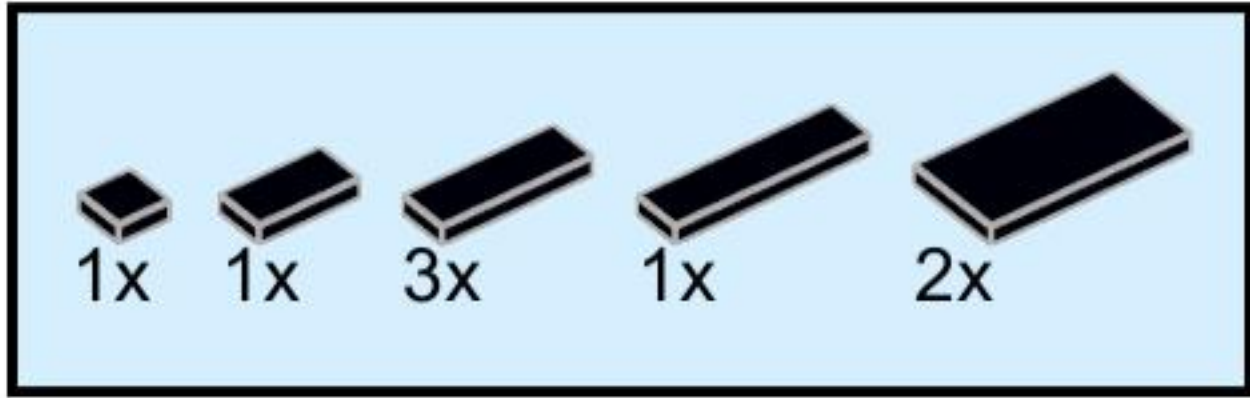

6

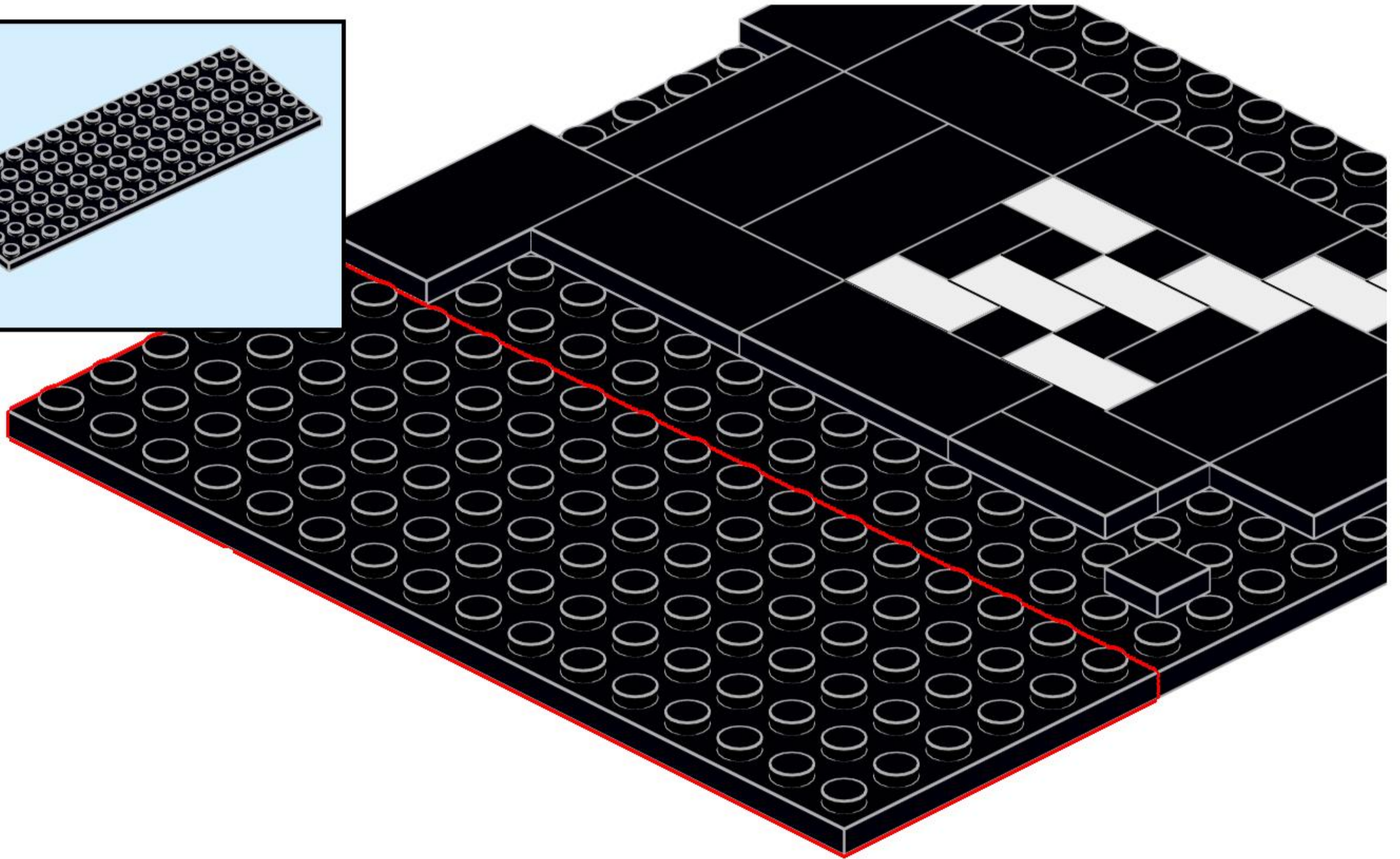
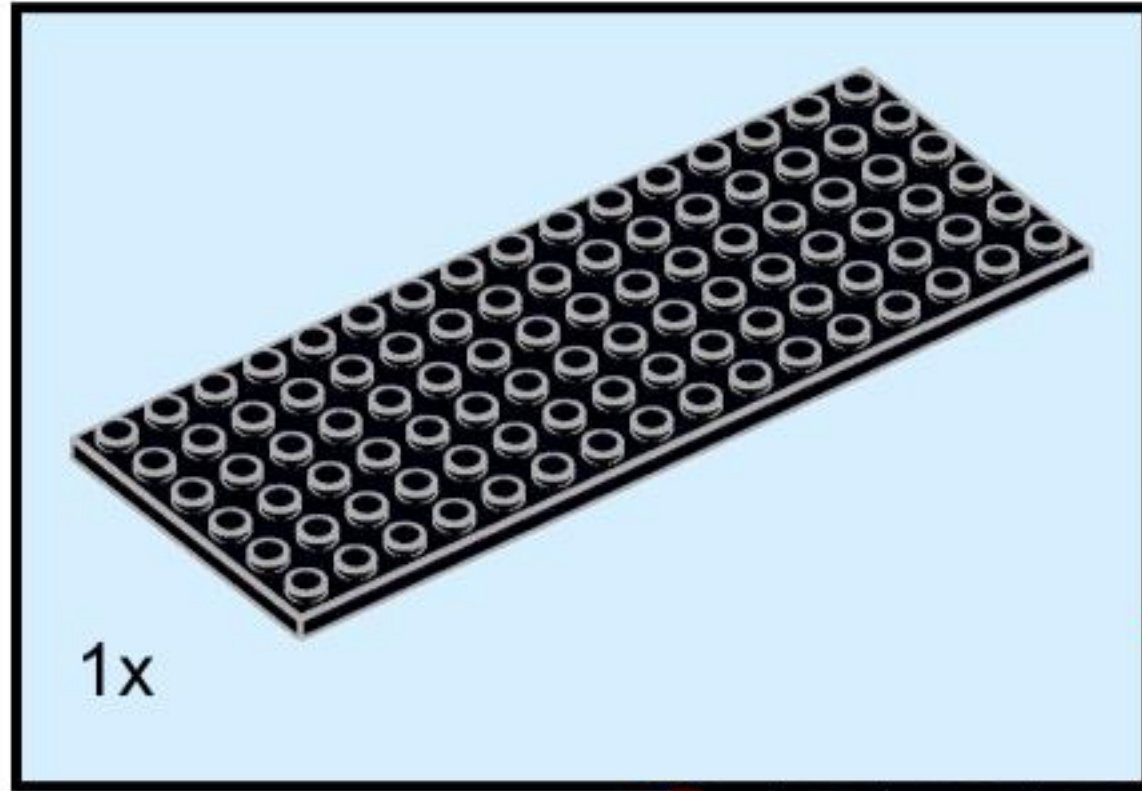

7

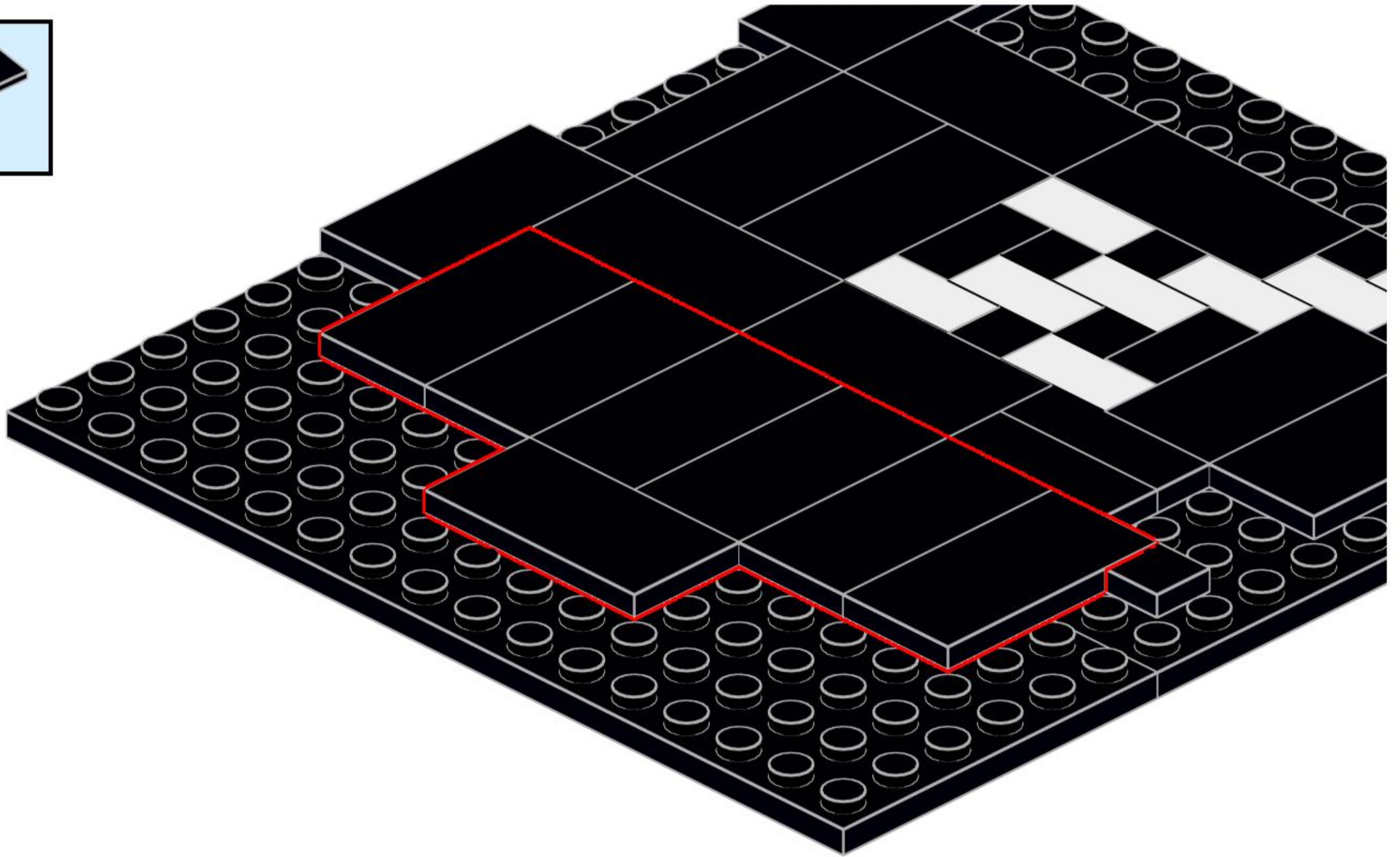
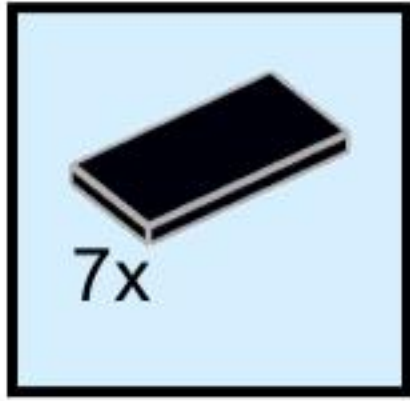

8

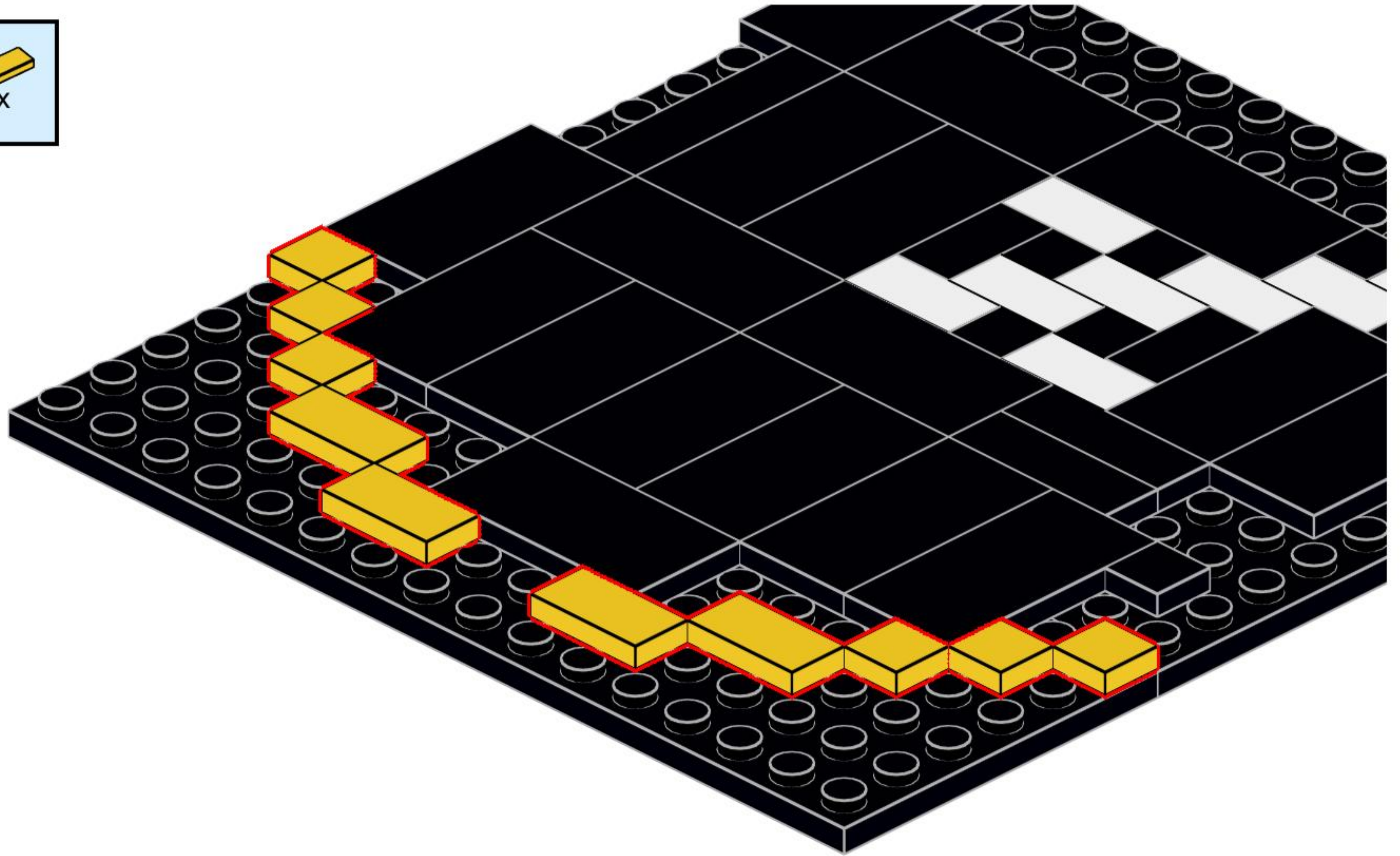
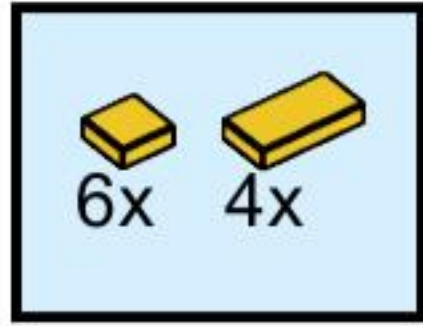

9

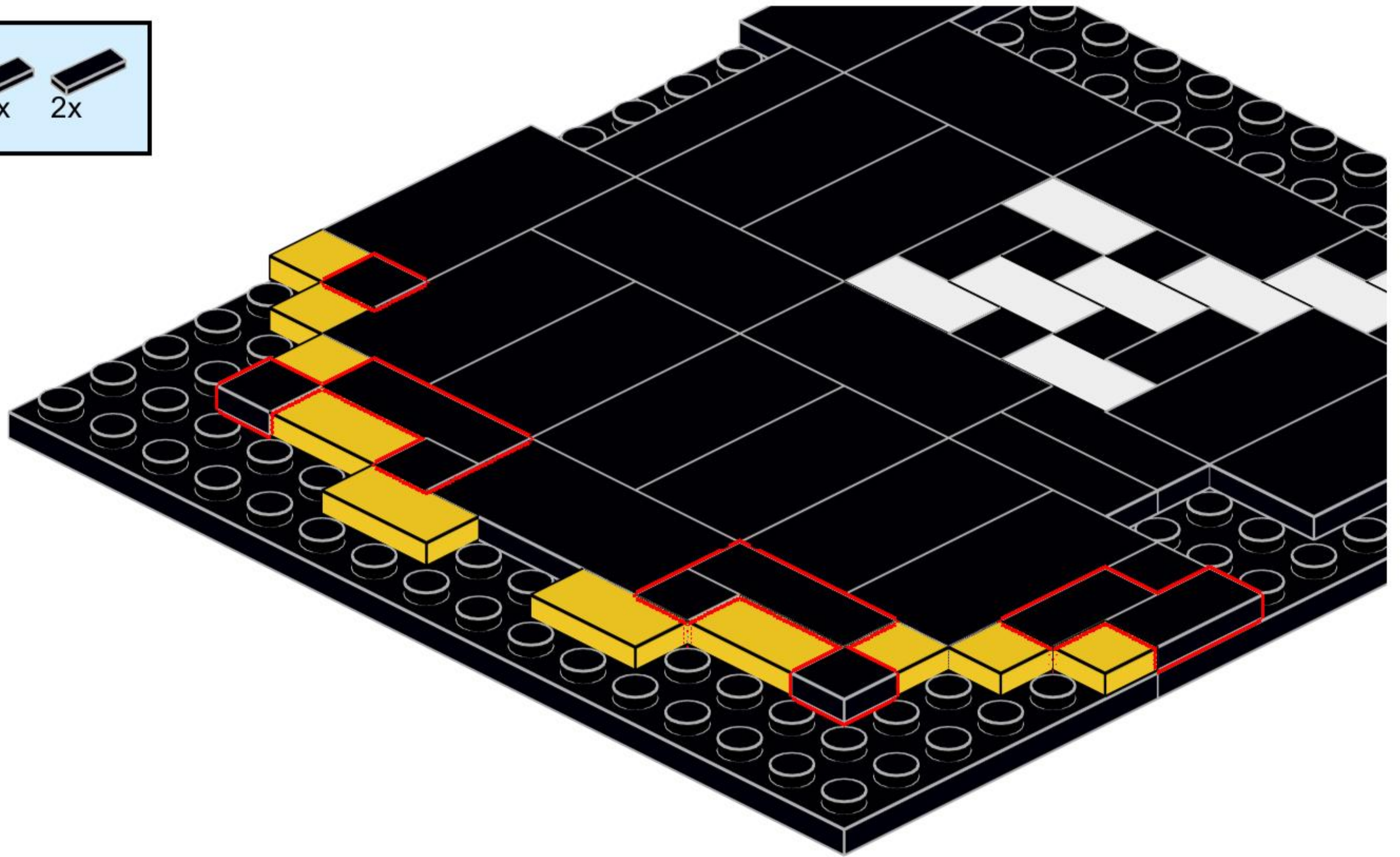
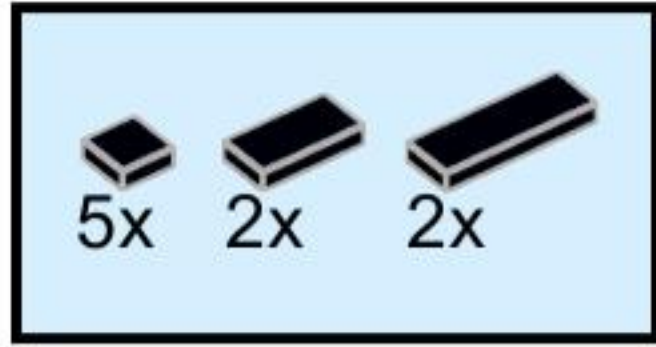

10

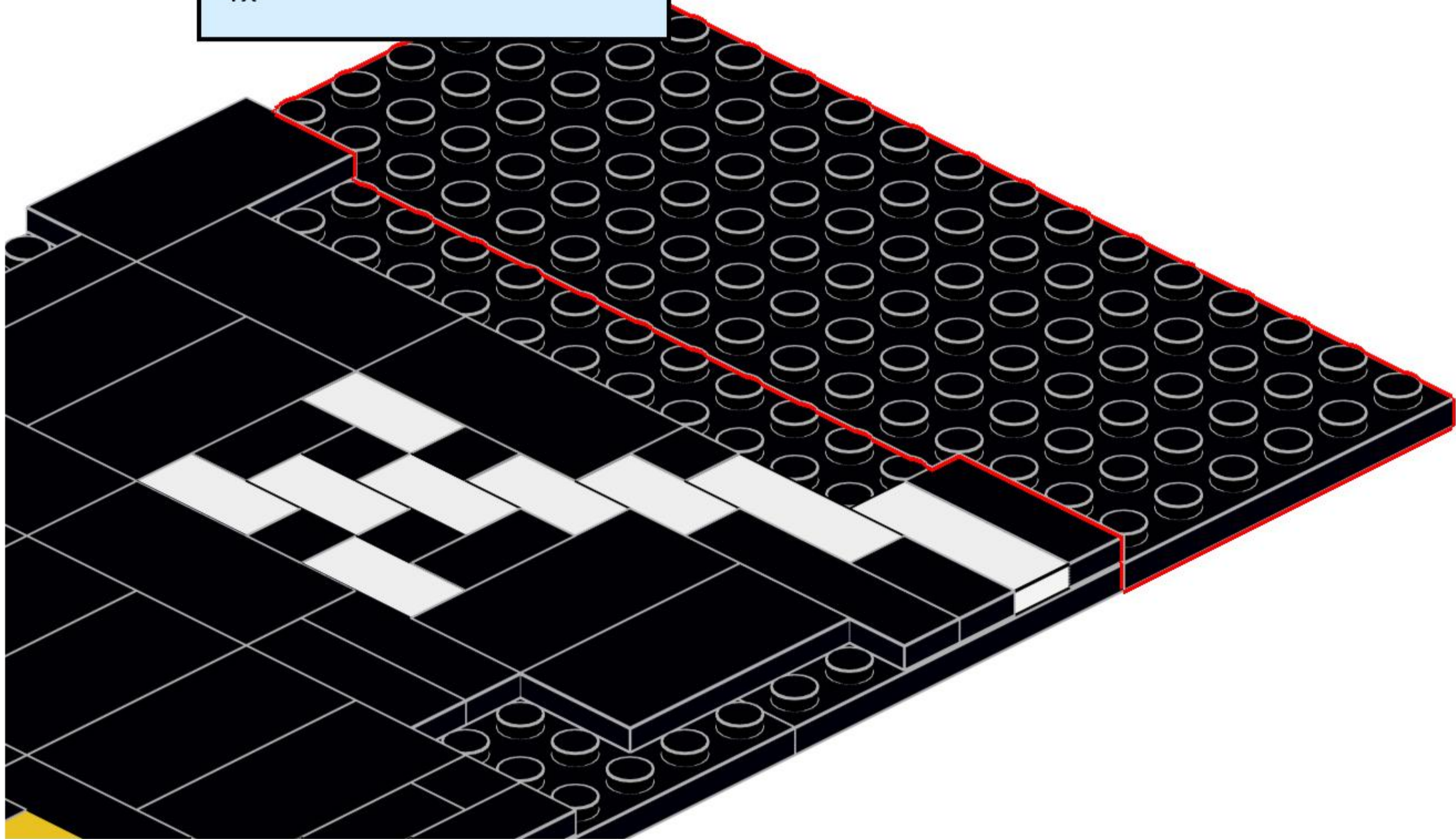
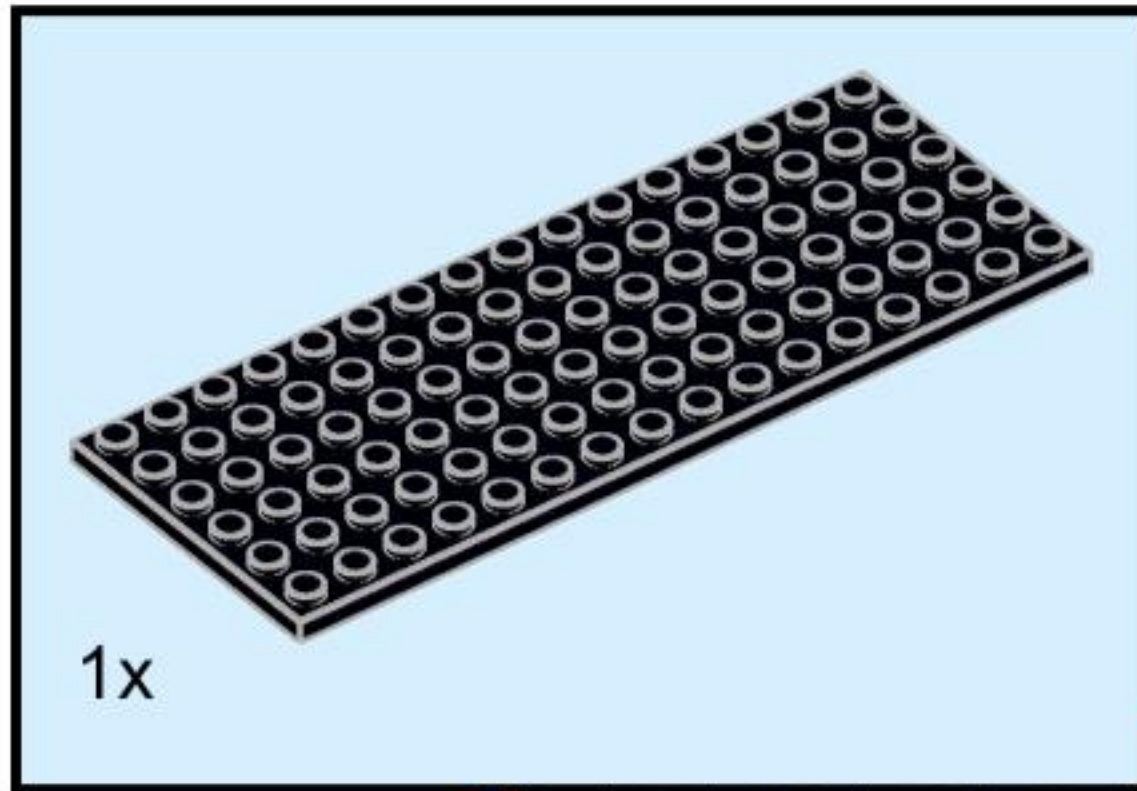

11

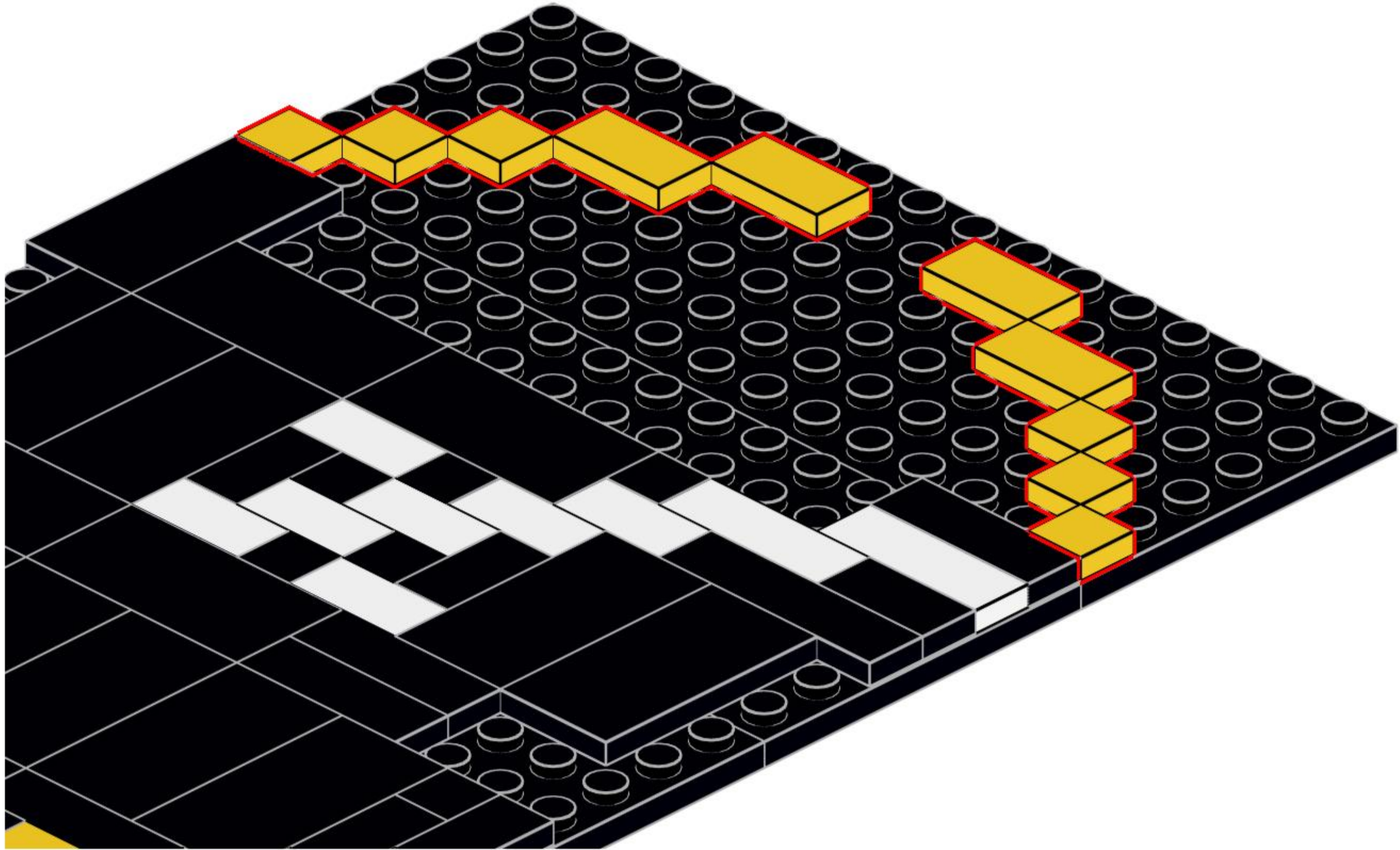
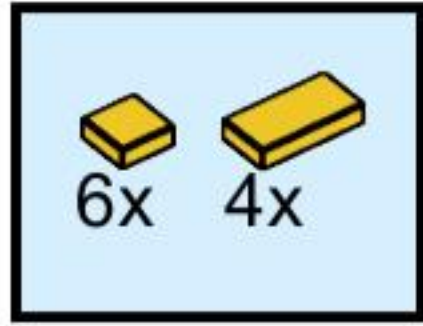

12

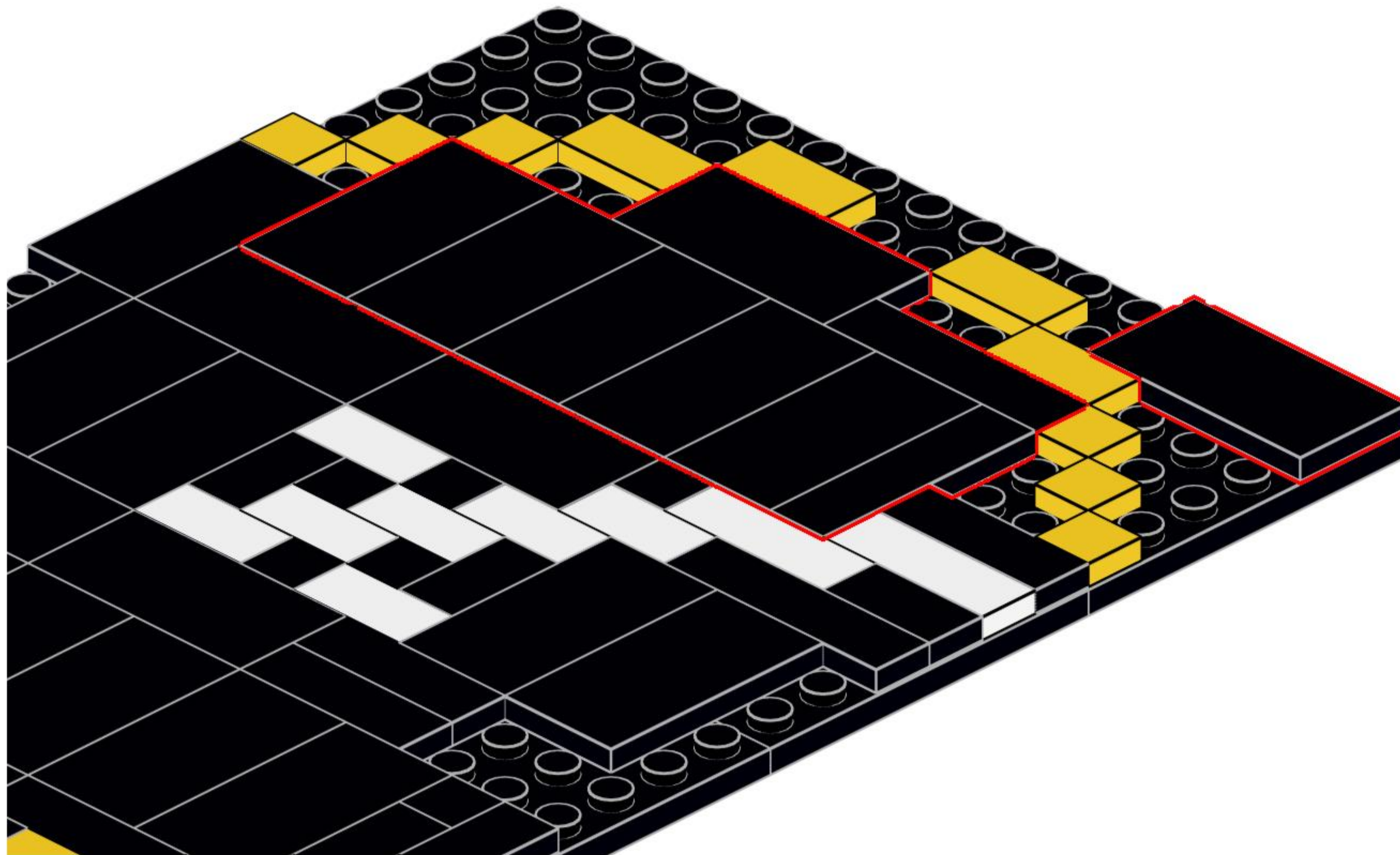
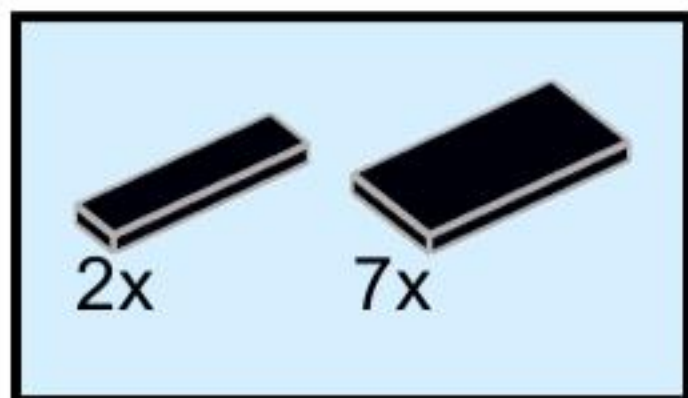

13

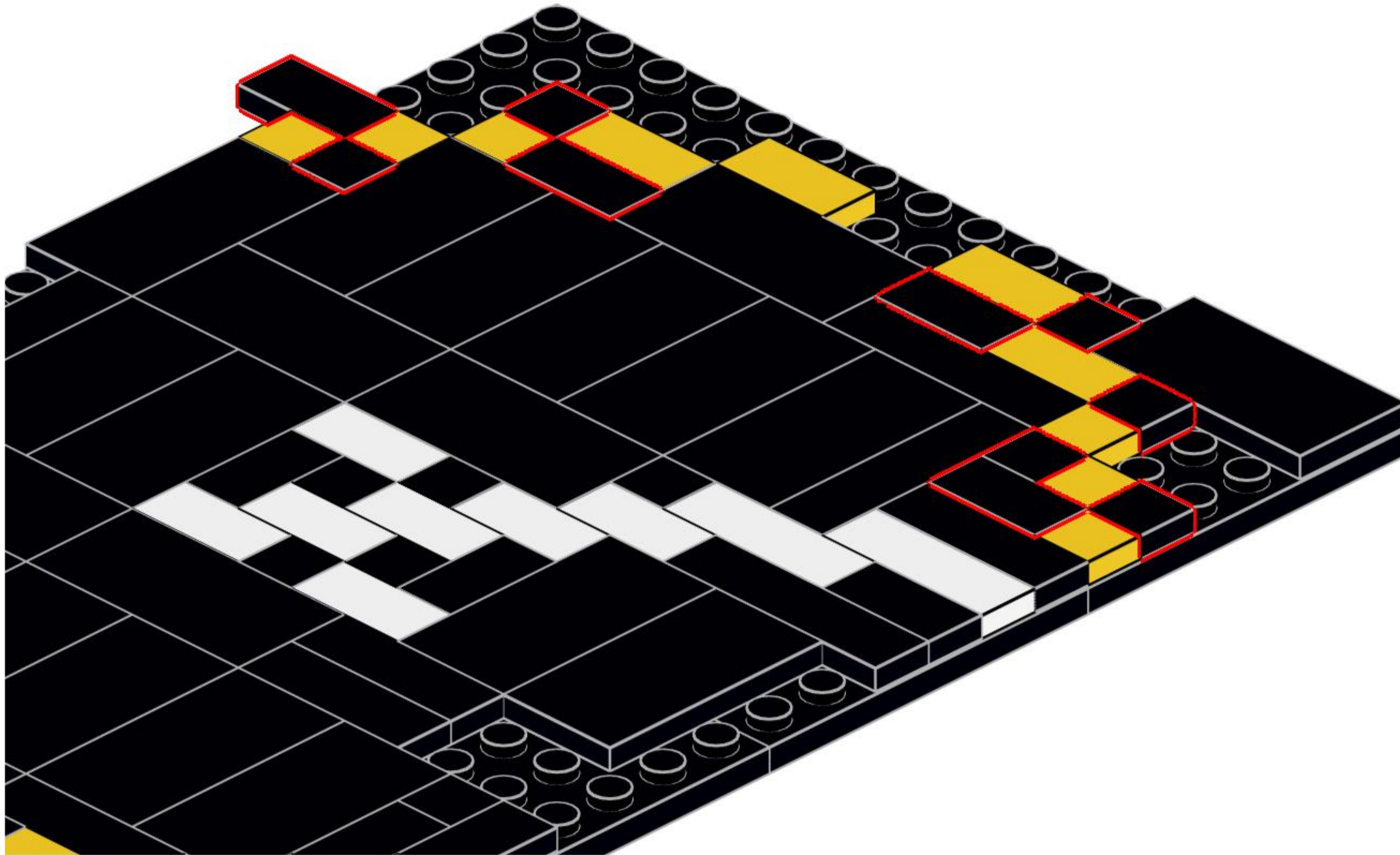
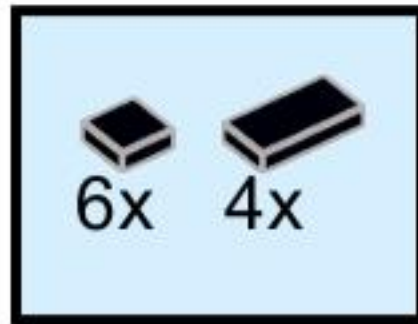

14

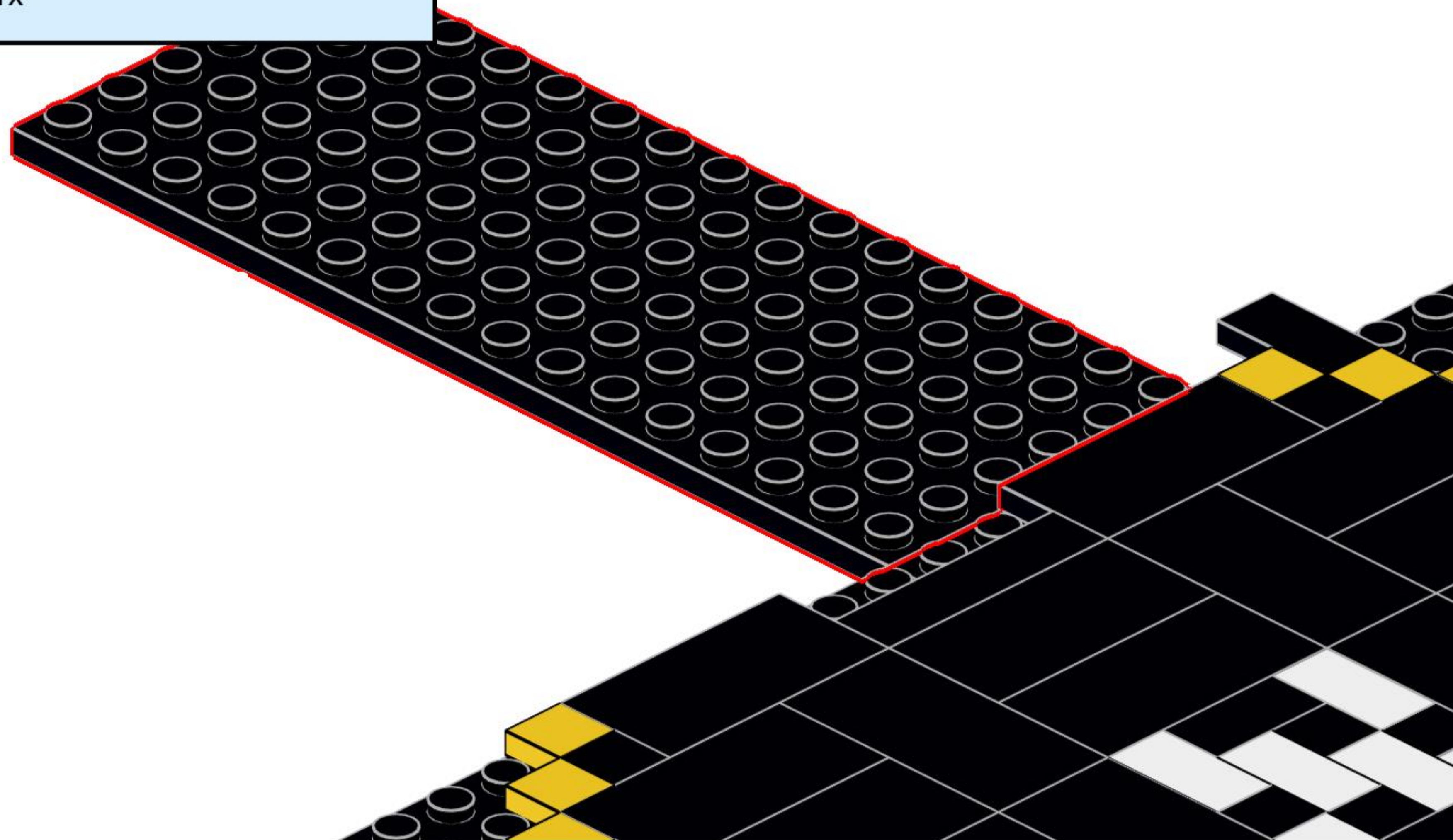
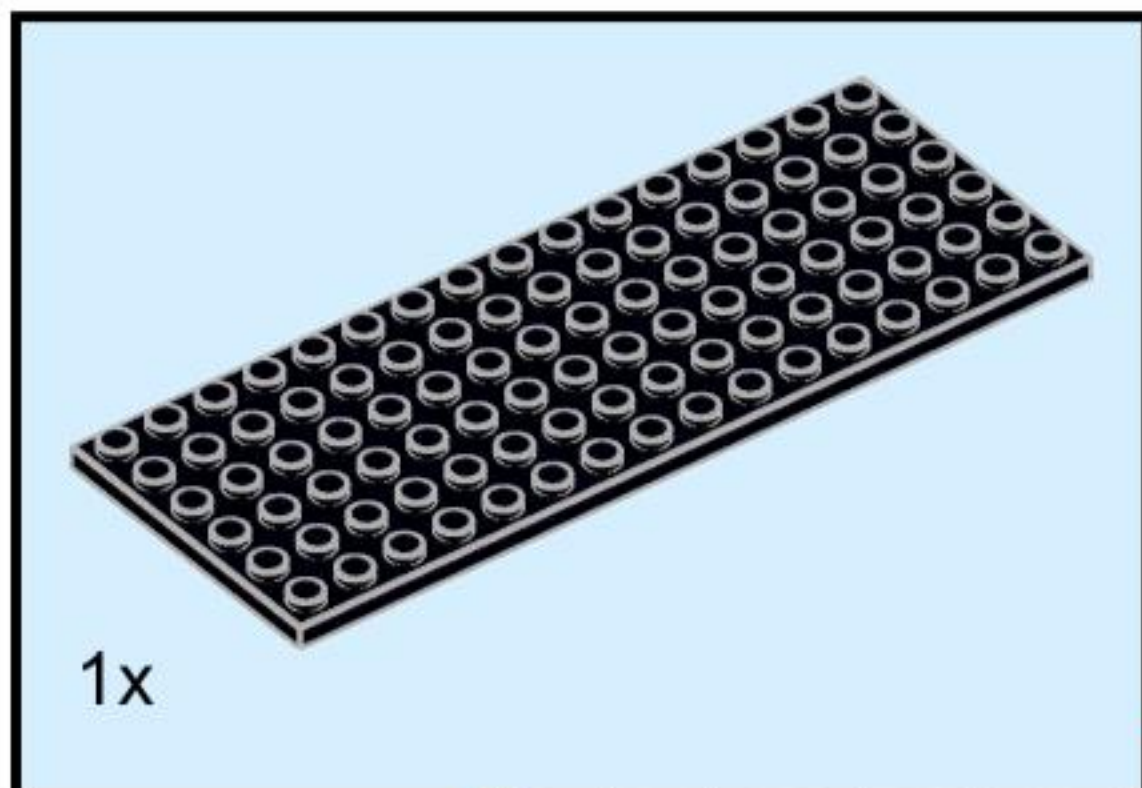

15

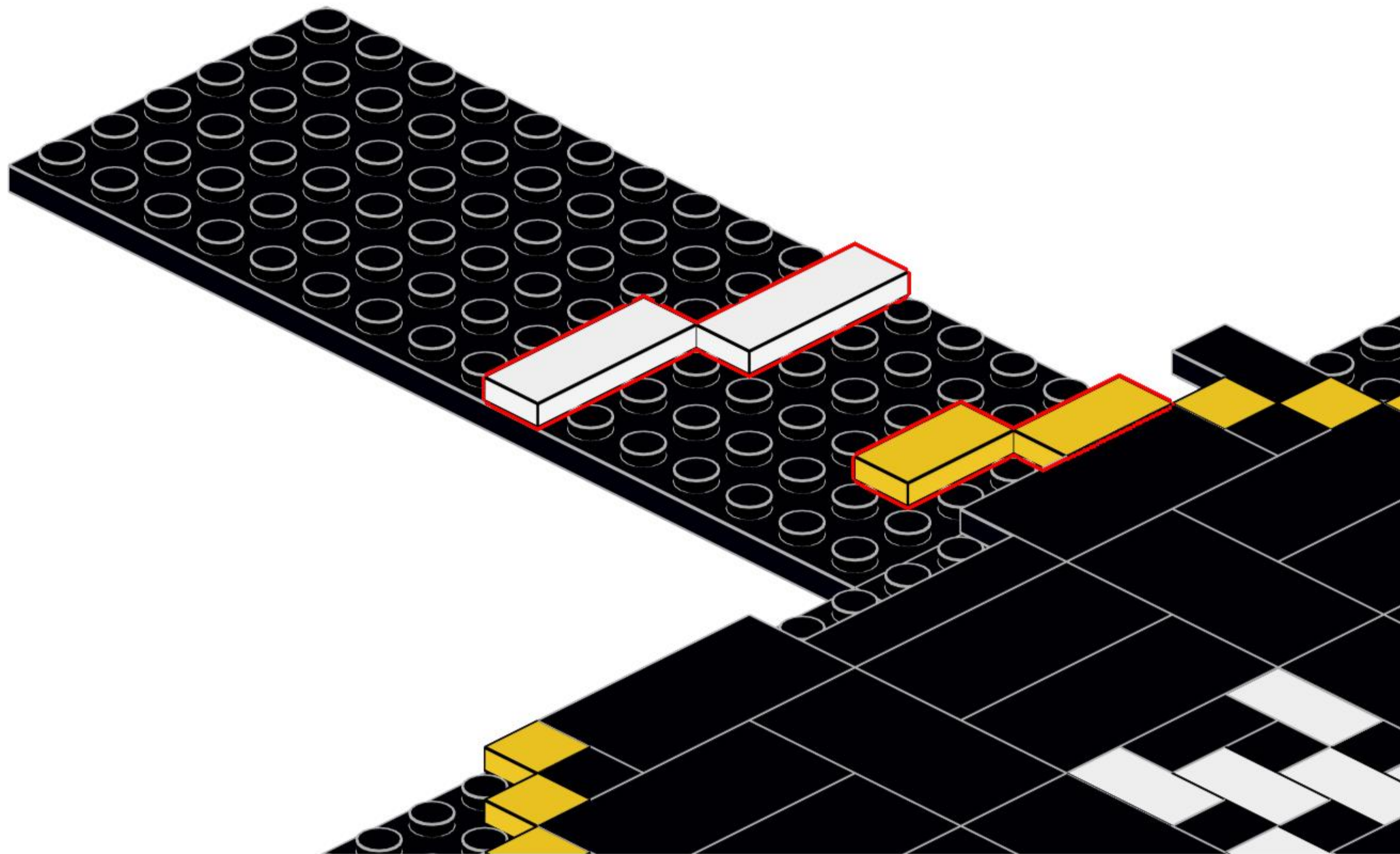
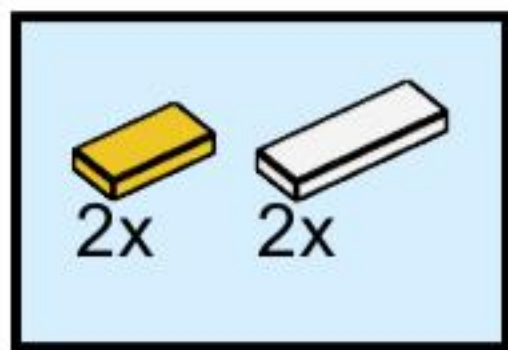

16

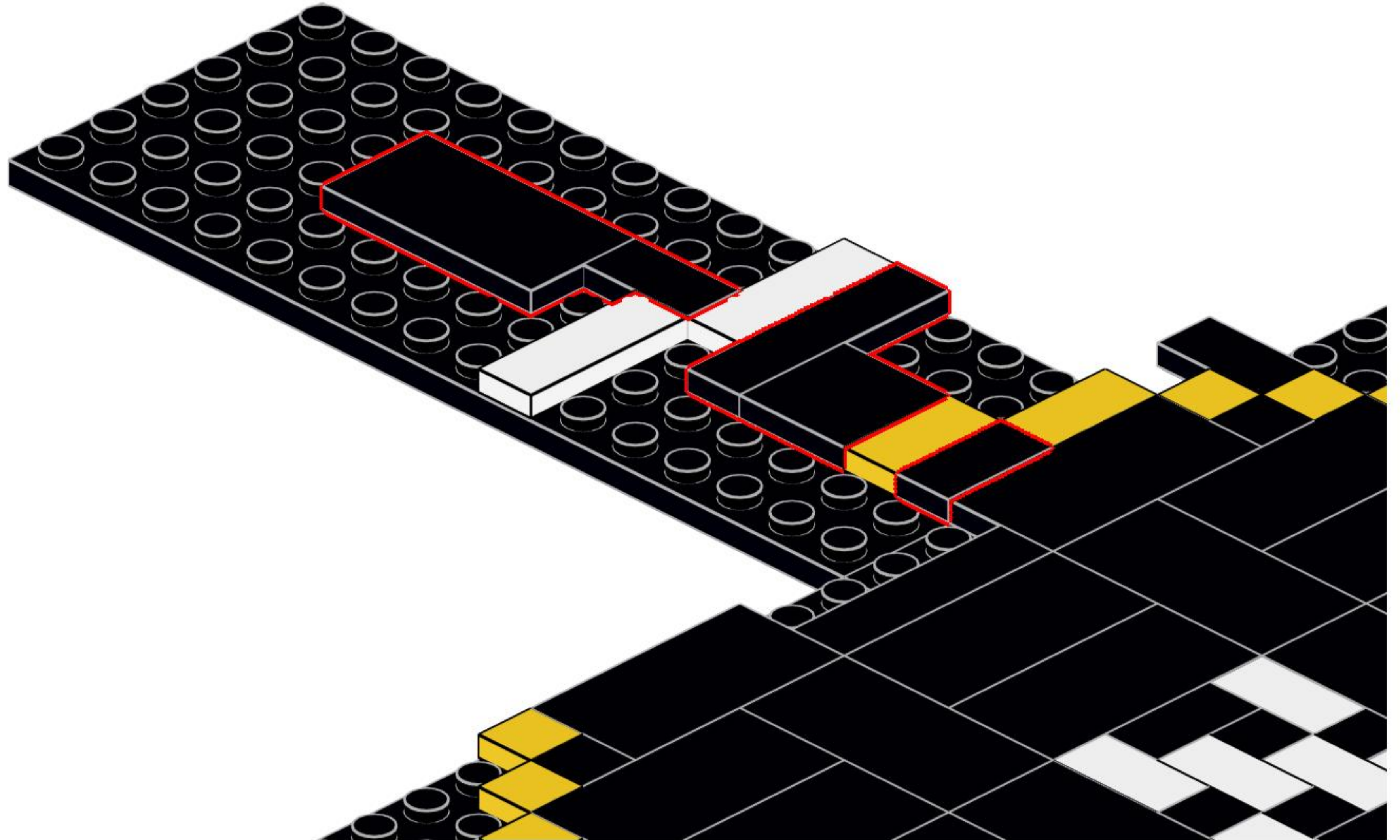
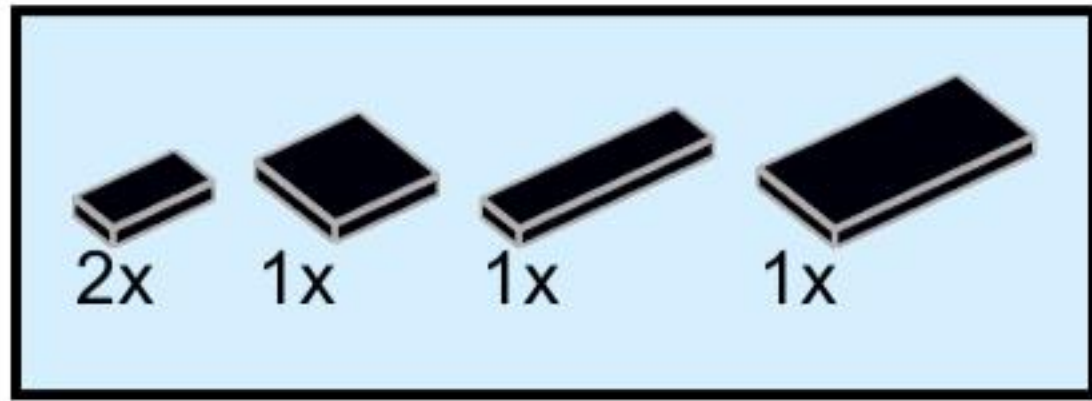

17

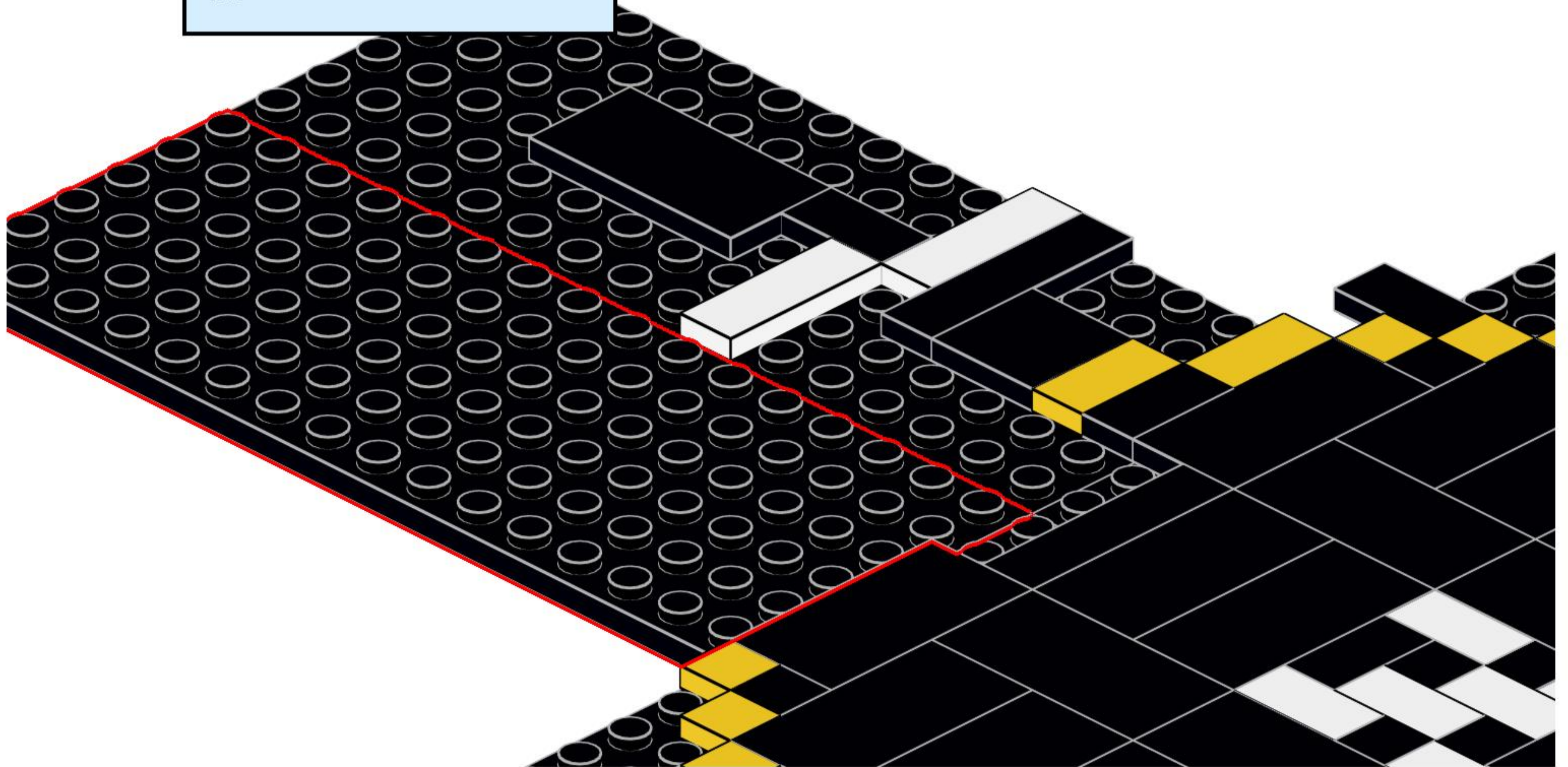
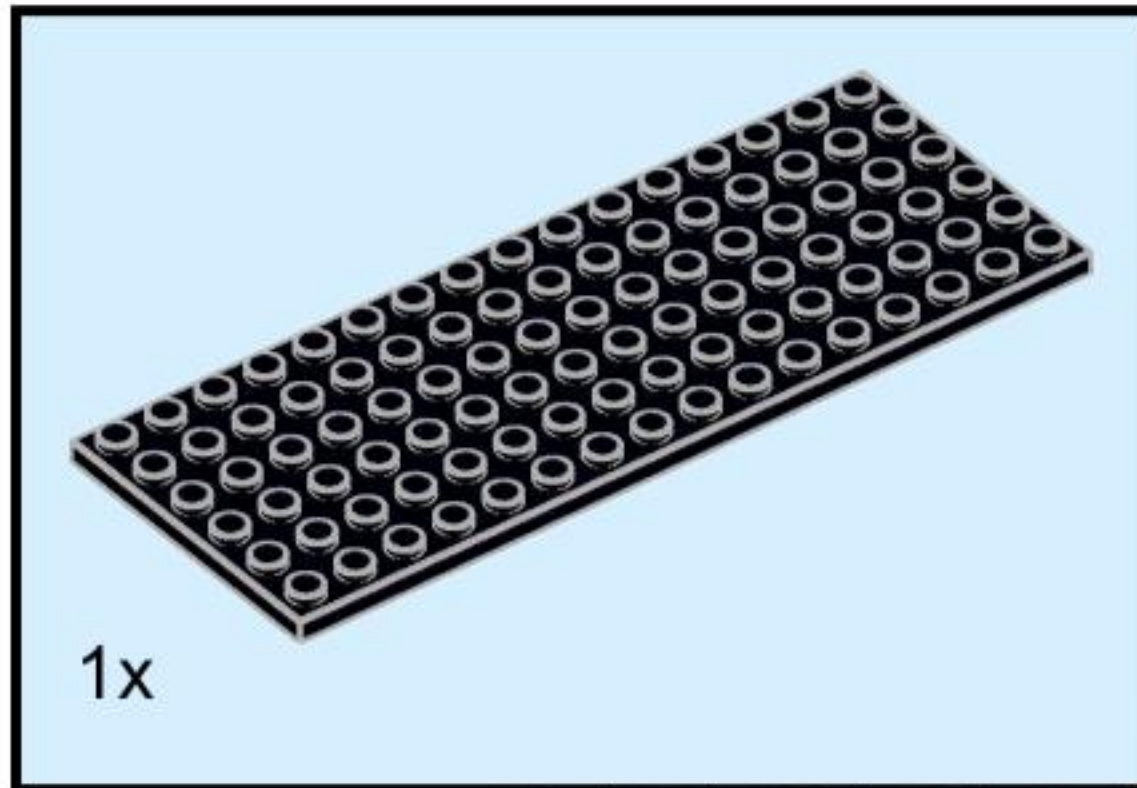

18

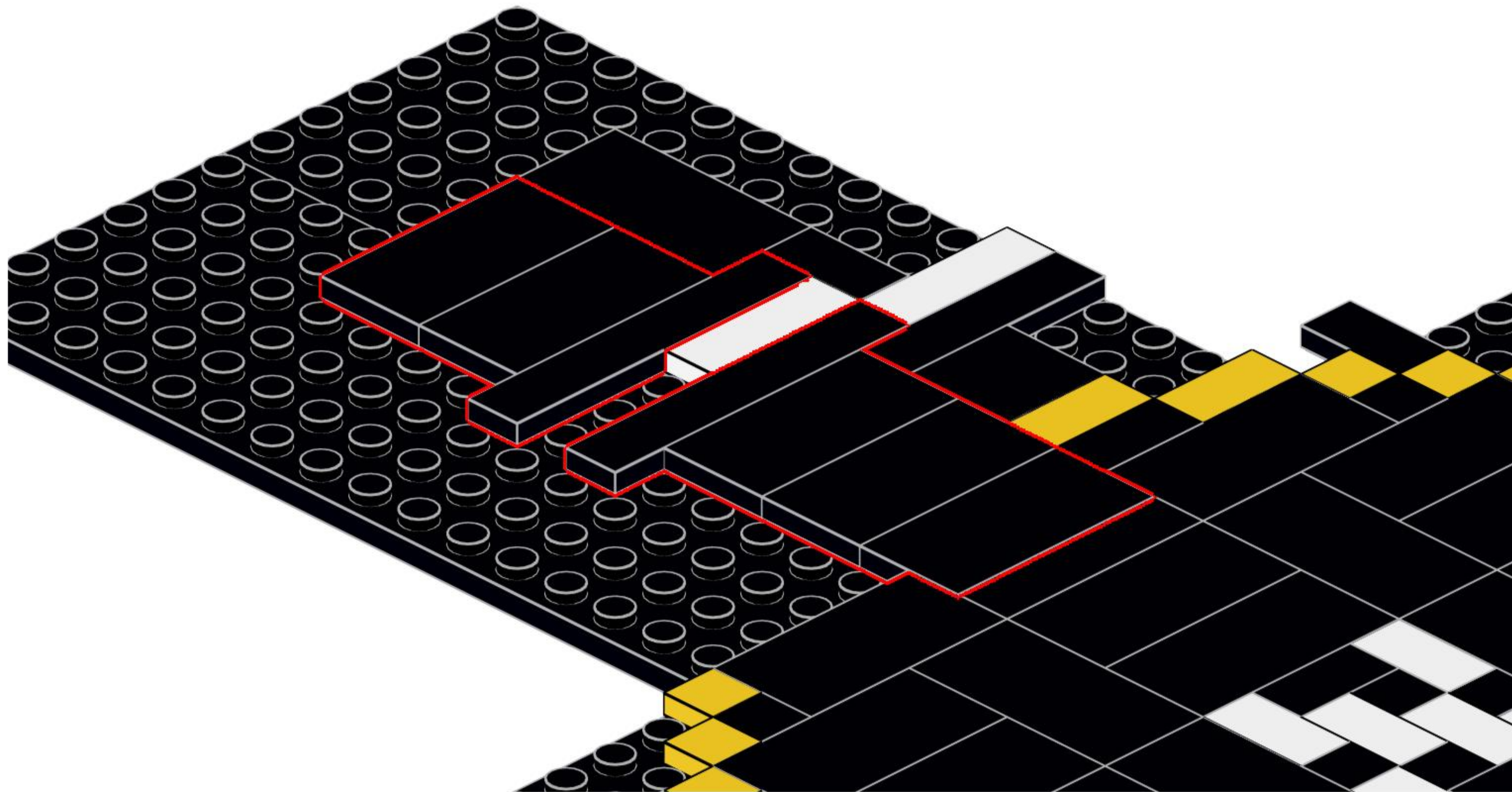
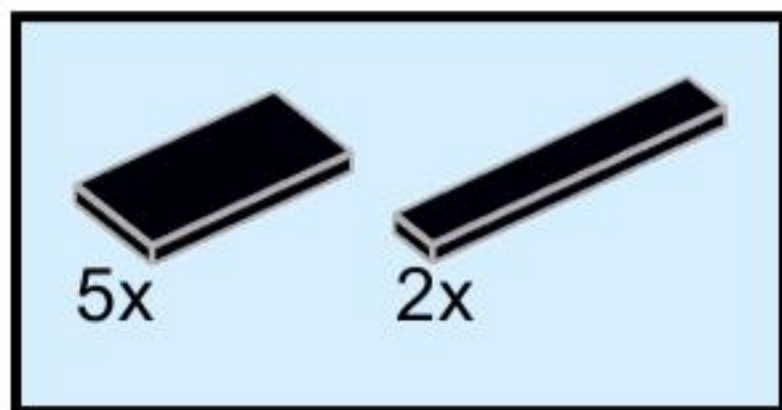

19

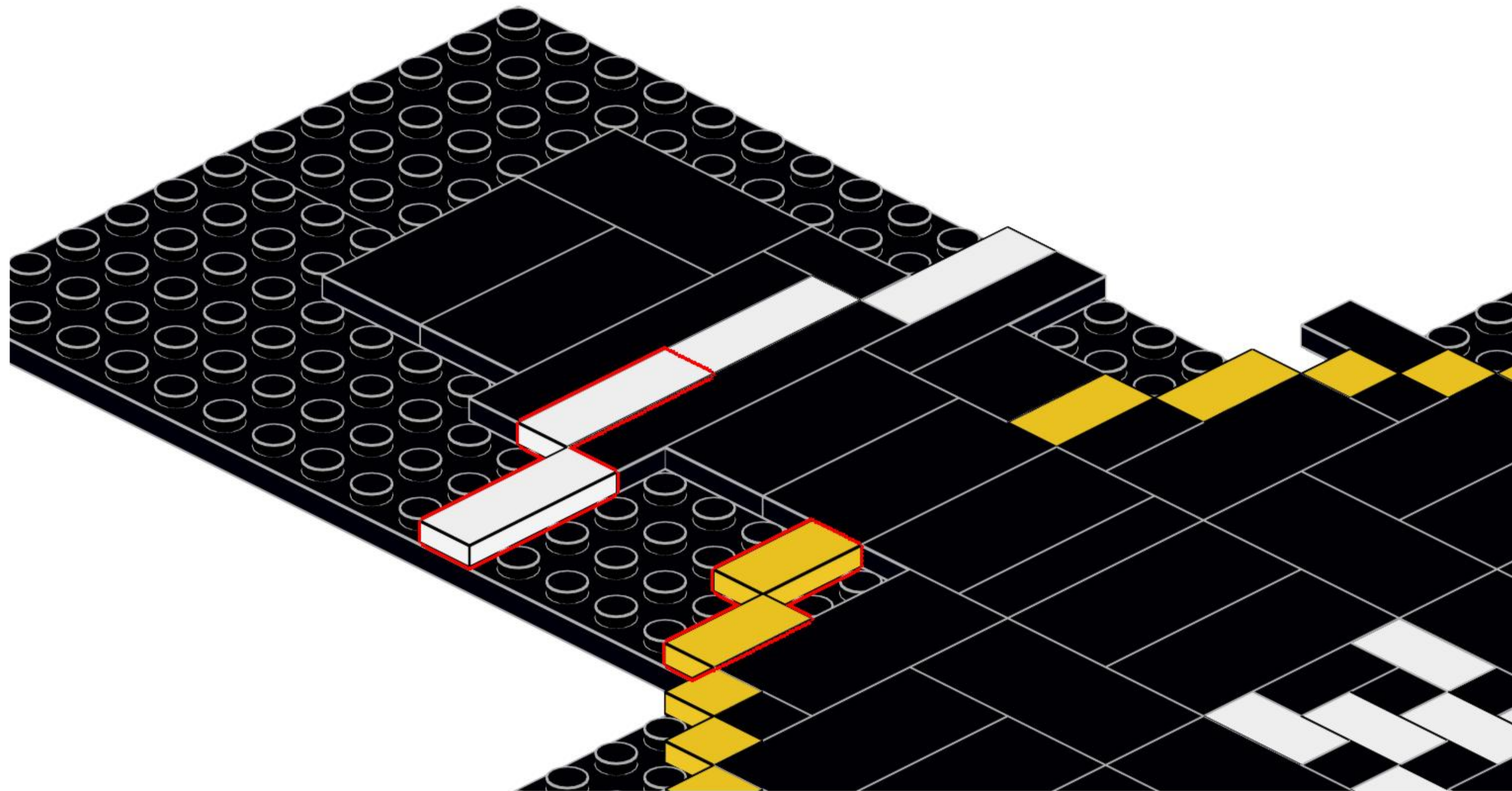
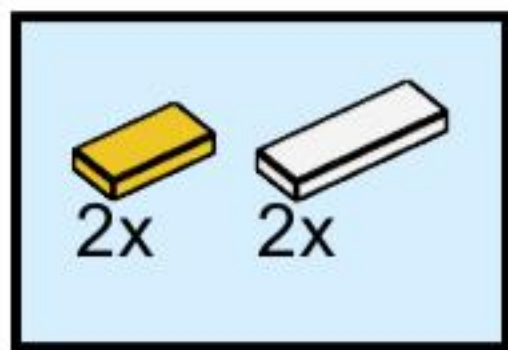

20

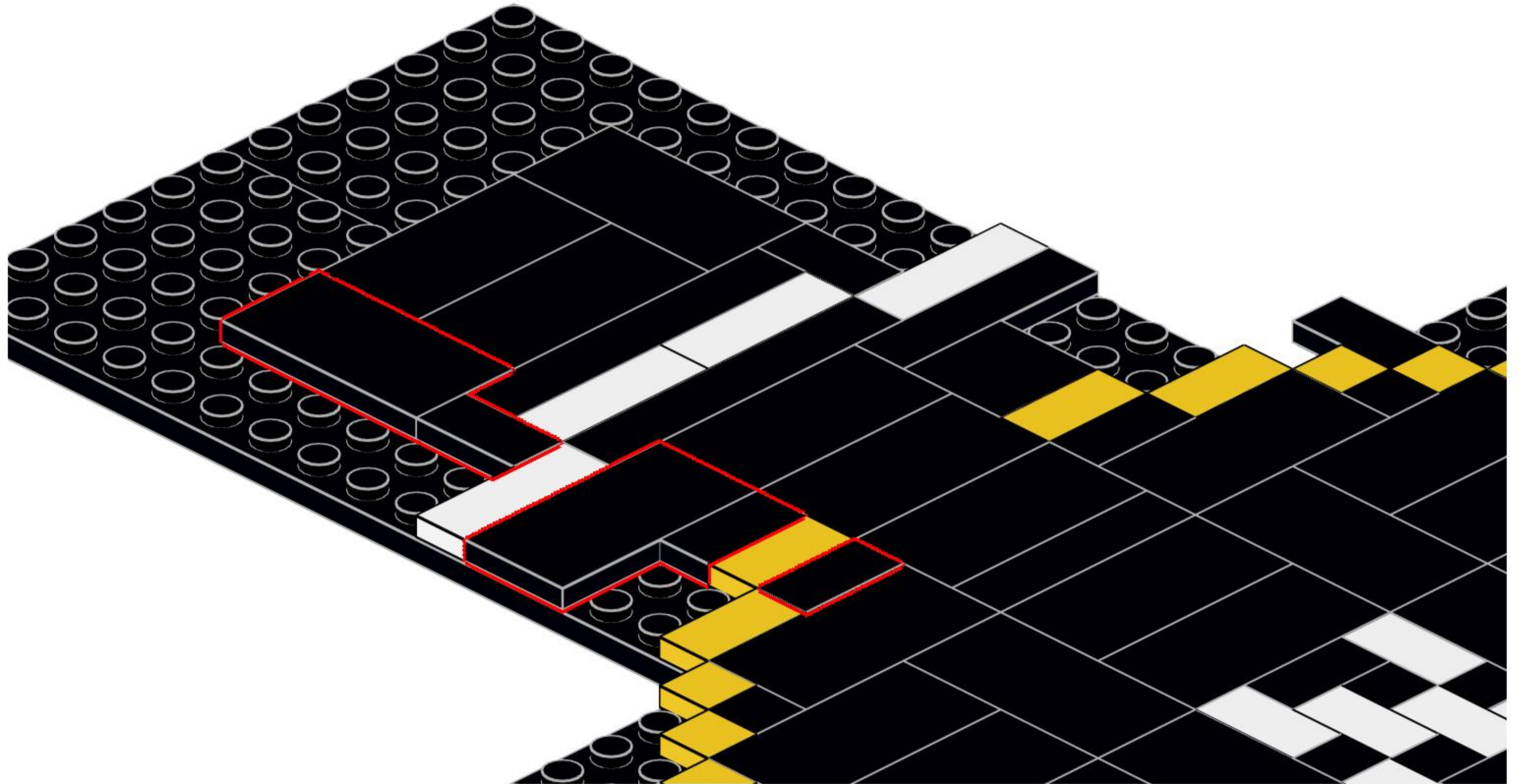
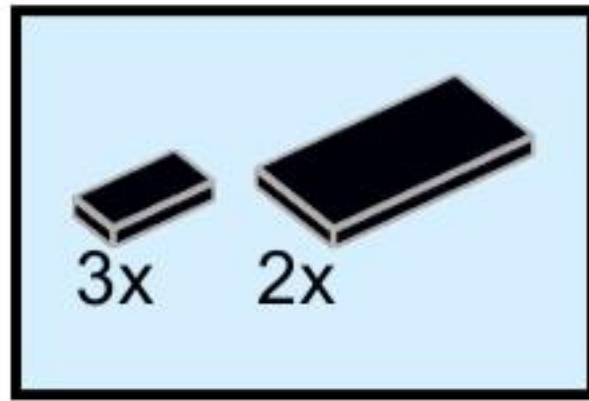

21

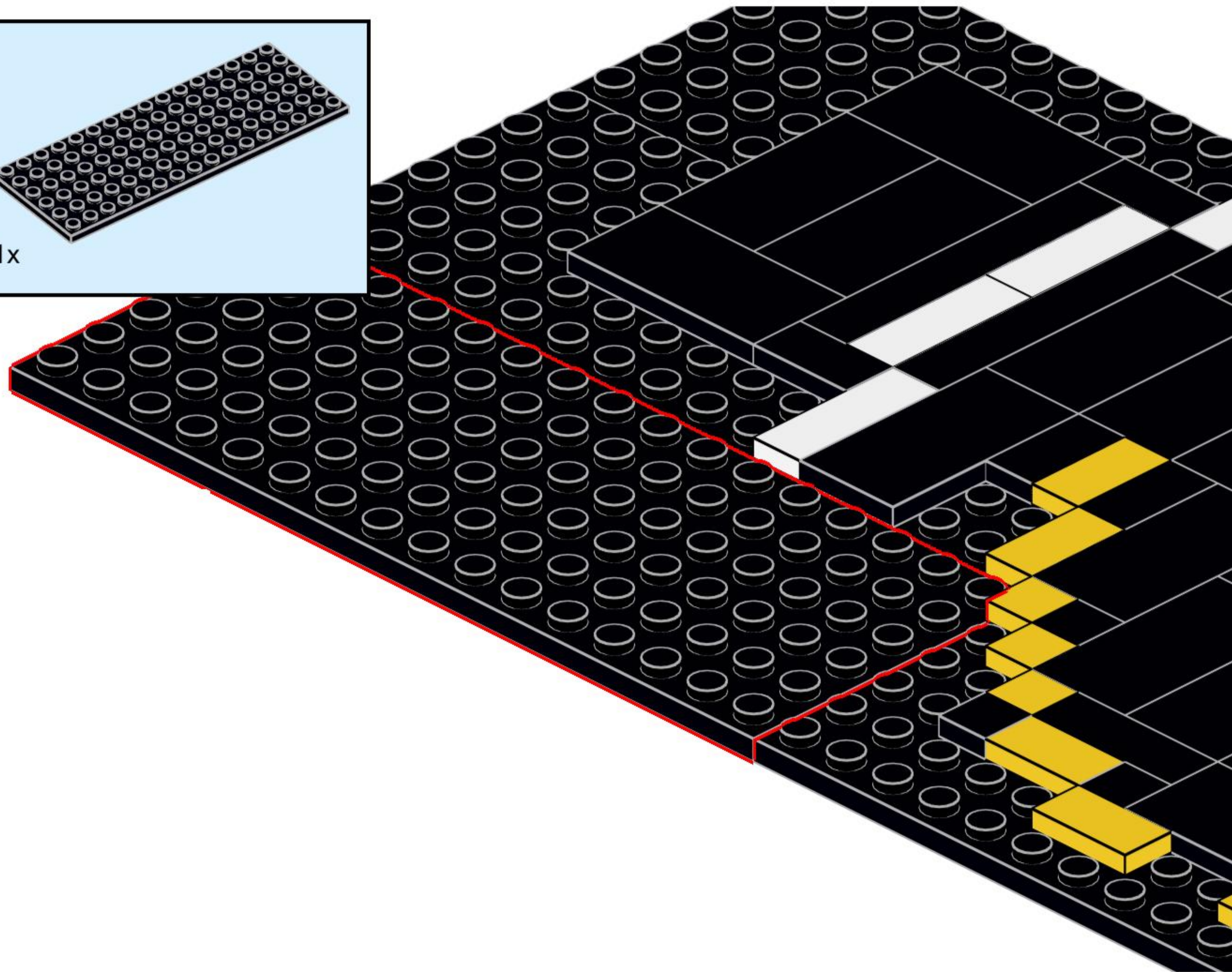
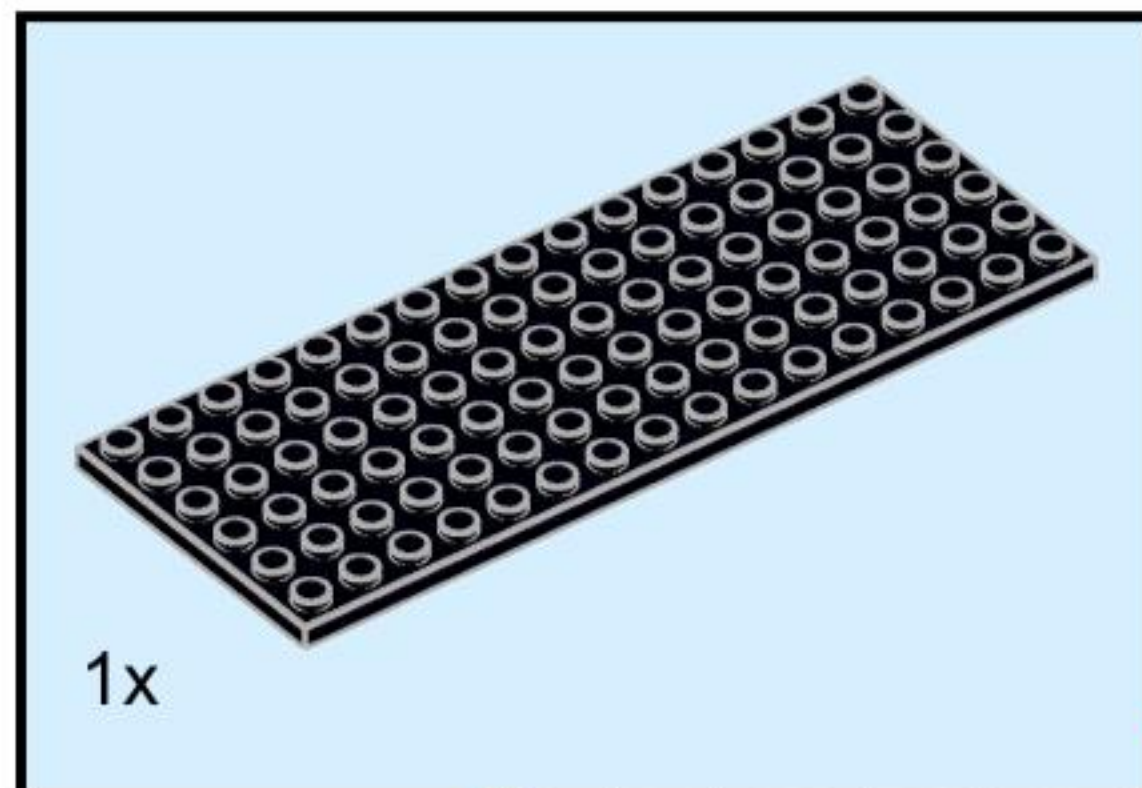

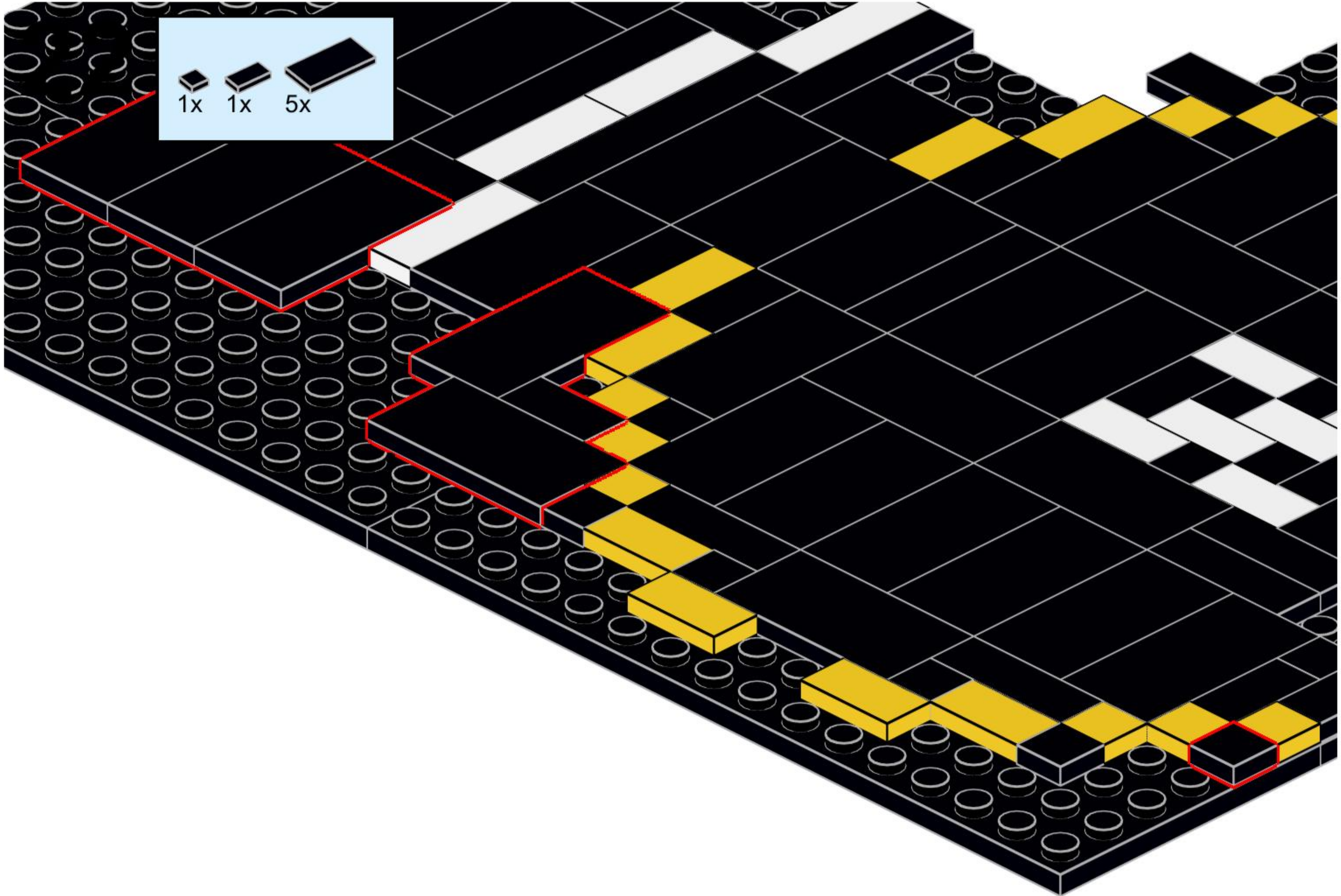

25

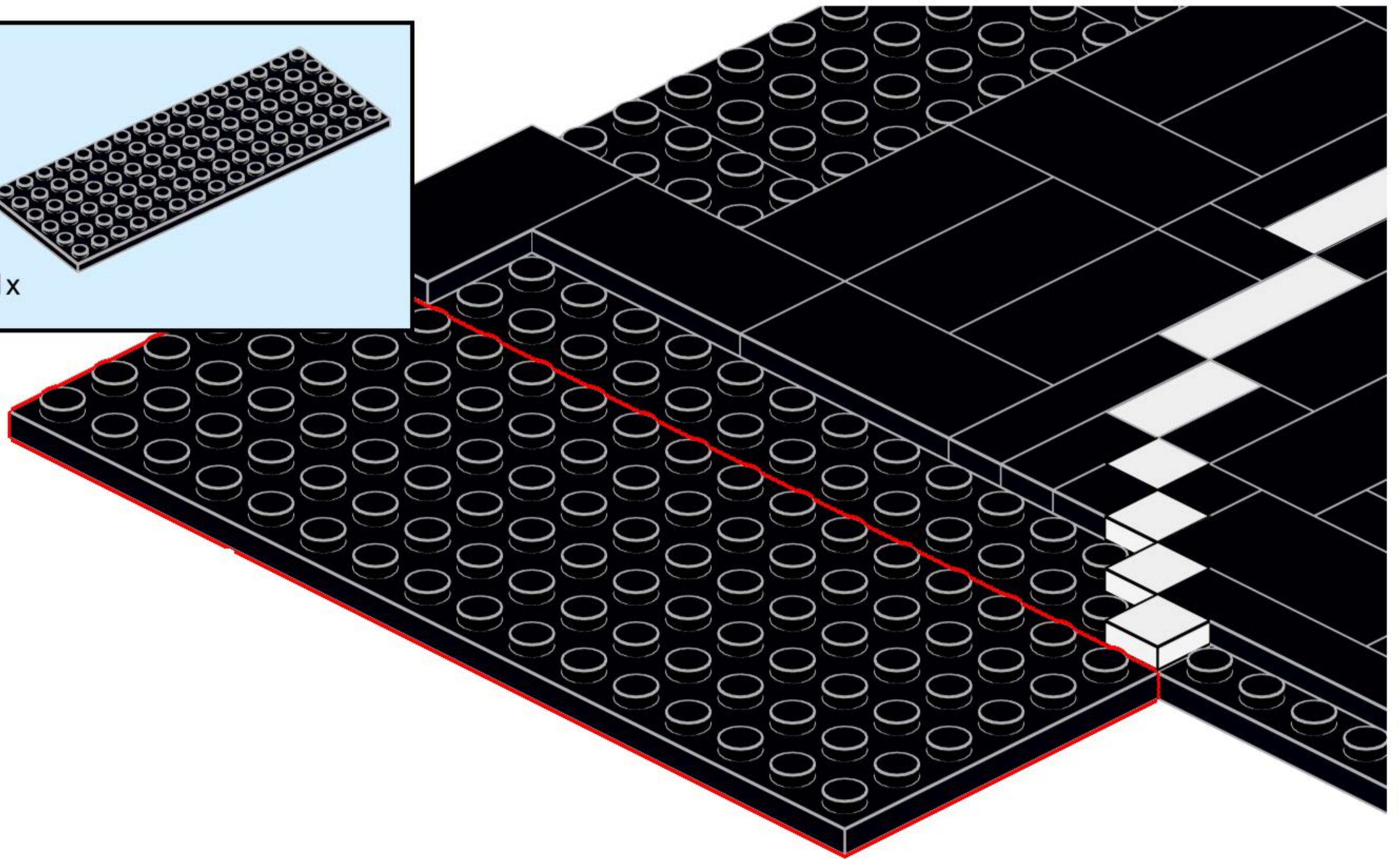
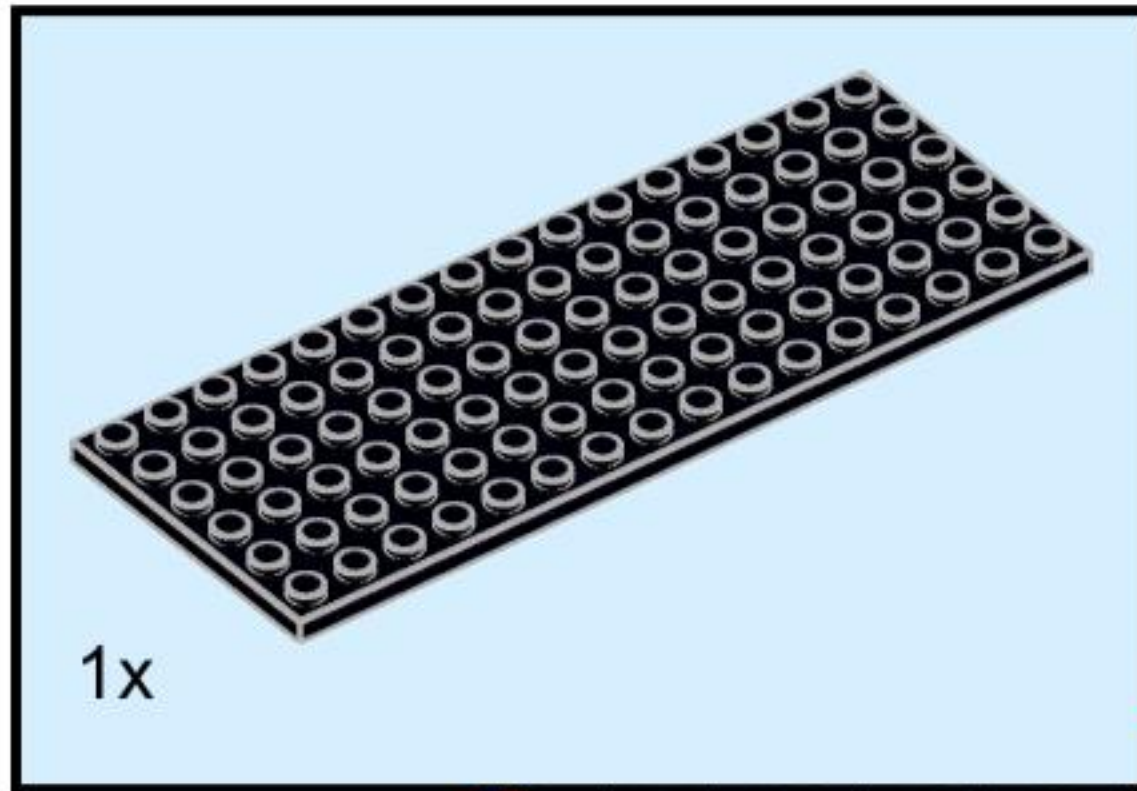

26

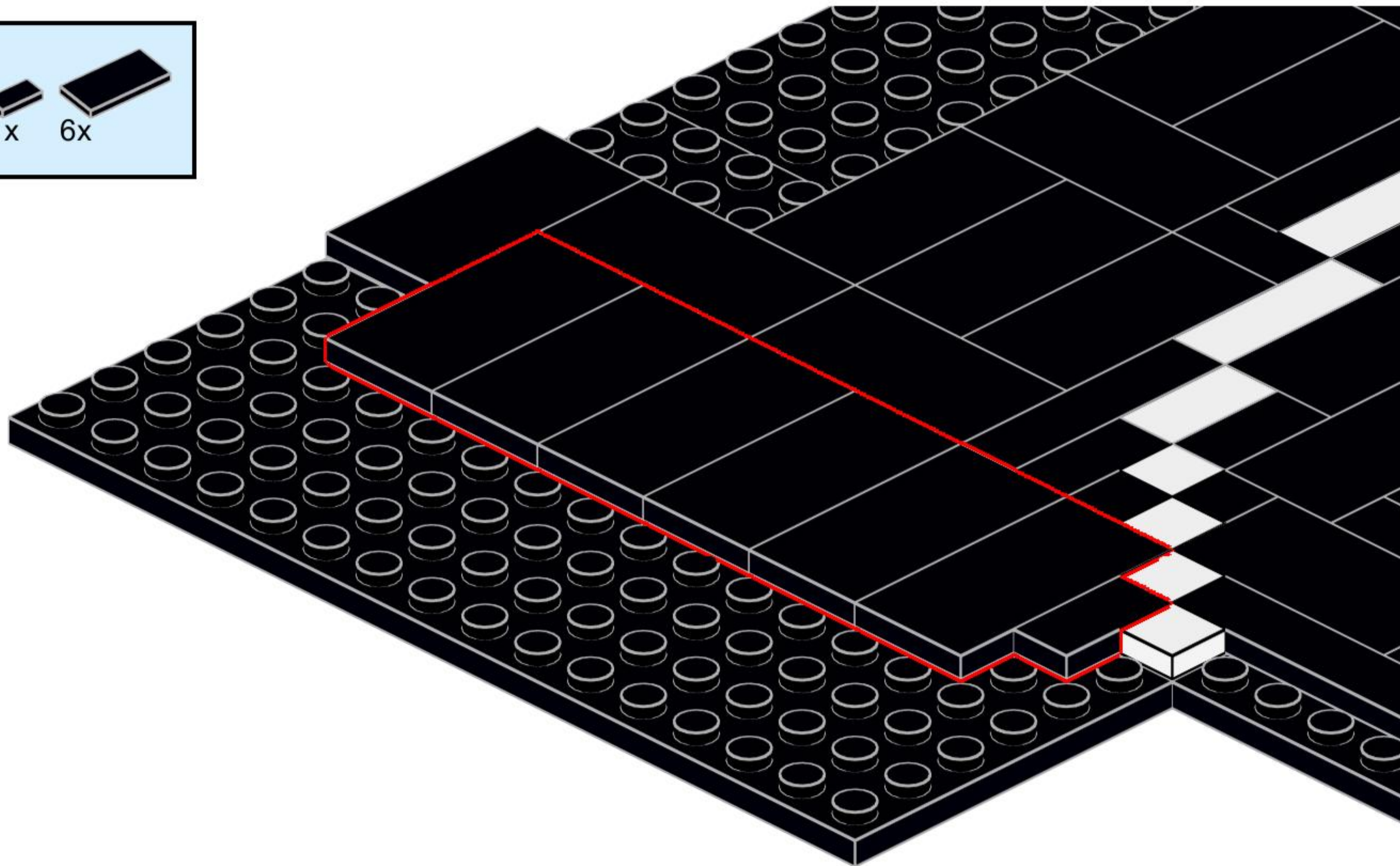
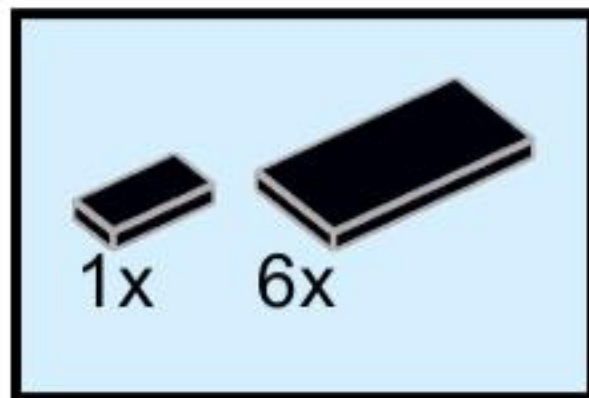

27

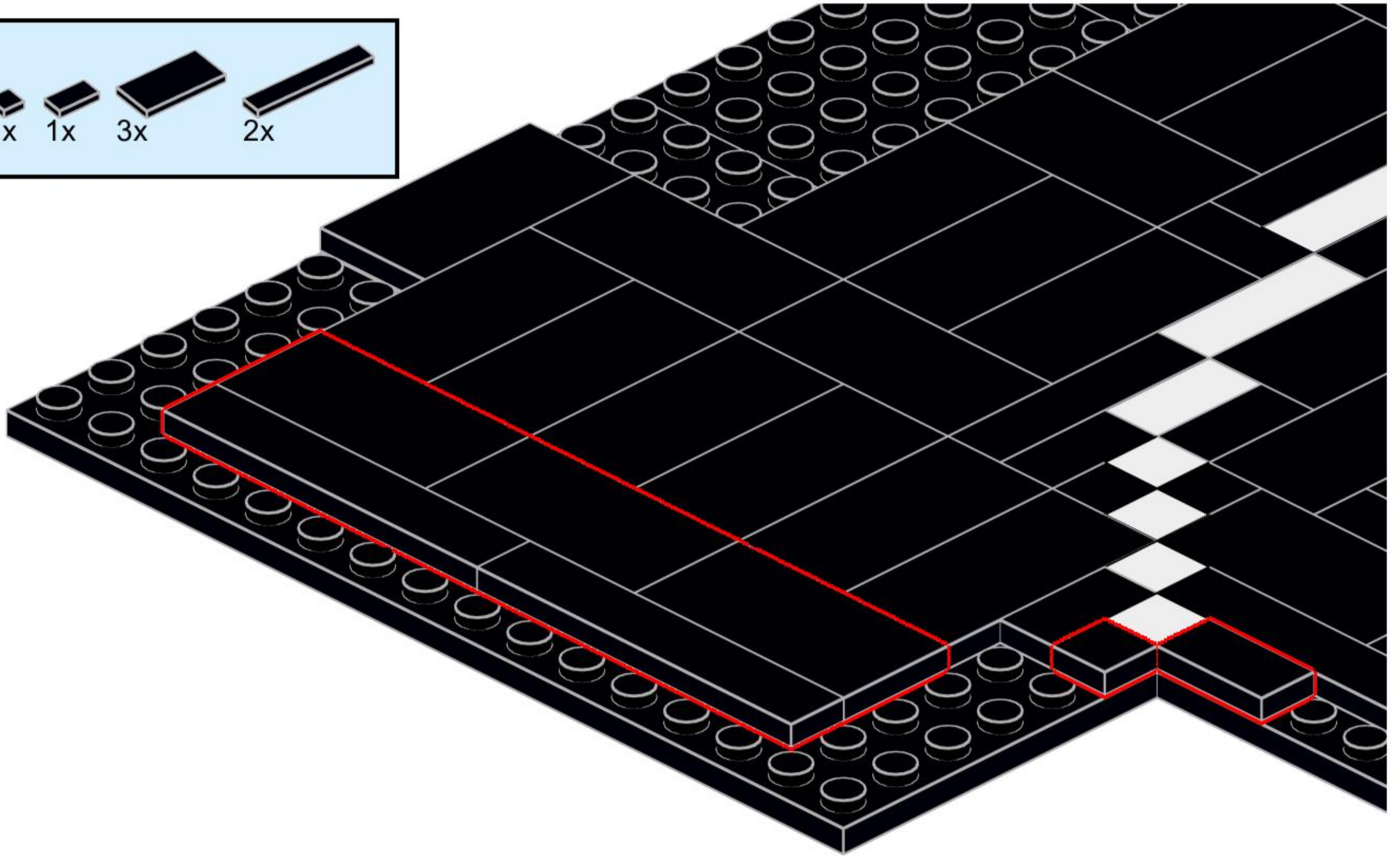
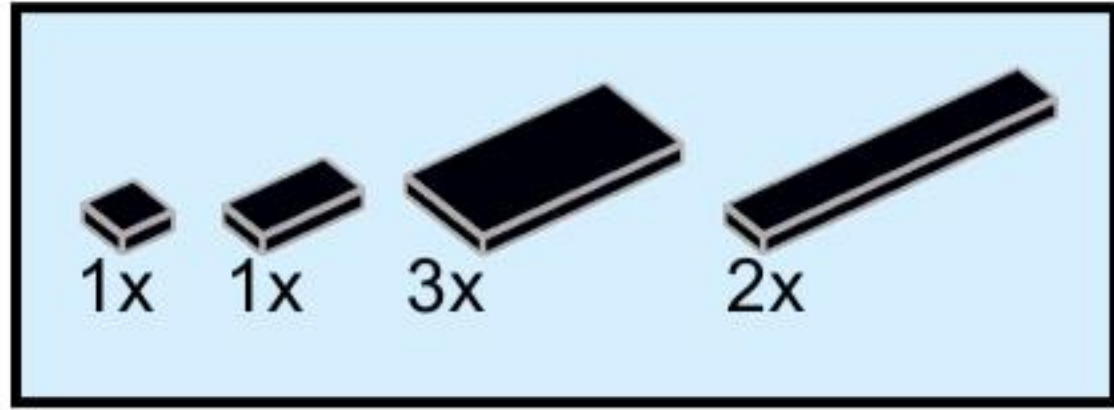

28

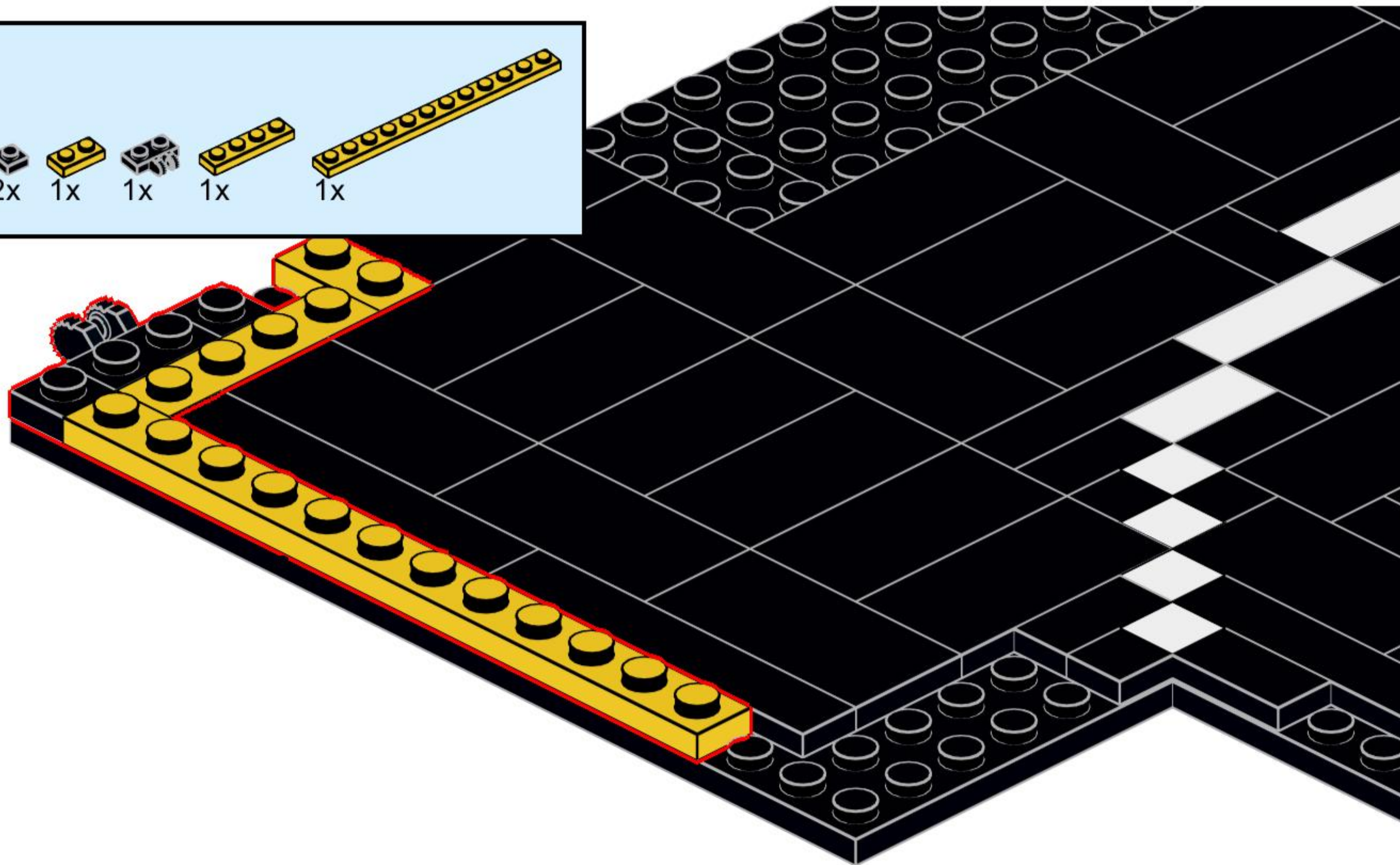
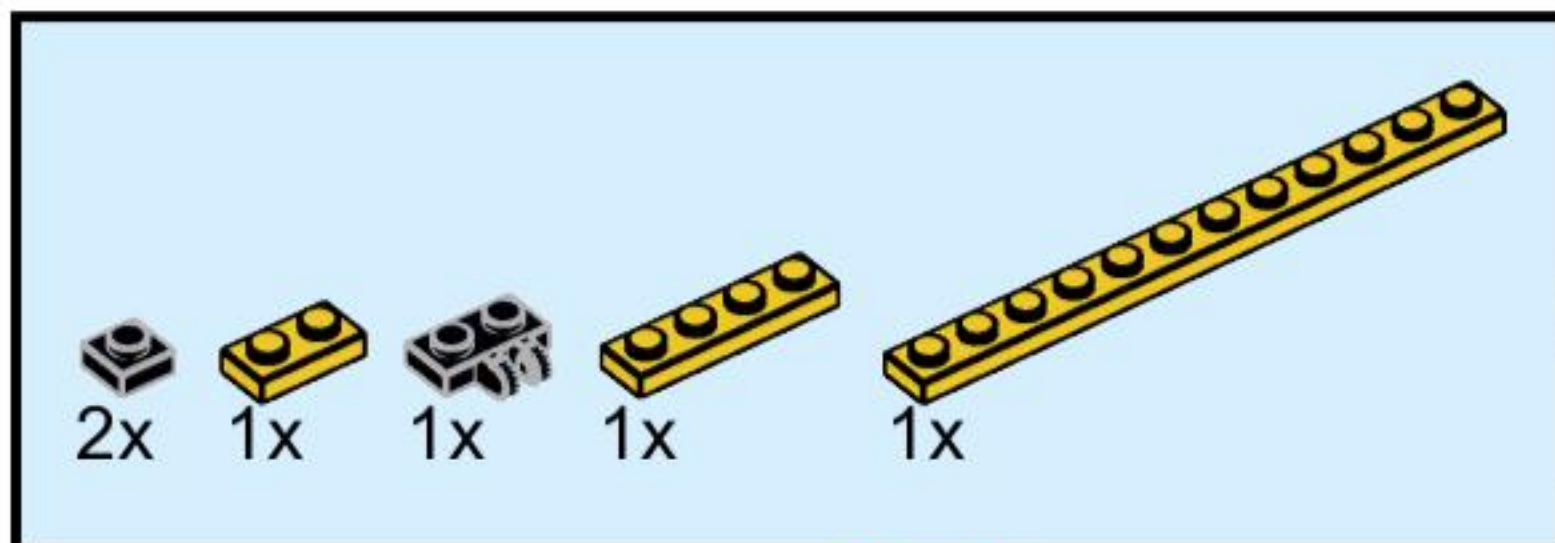

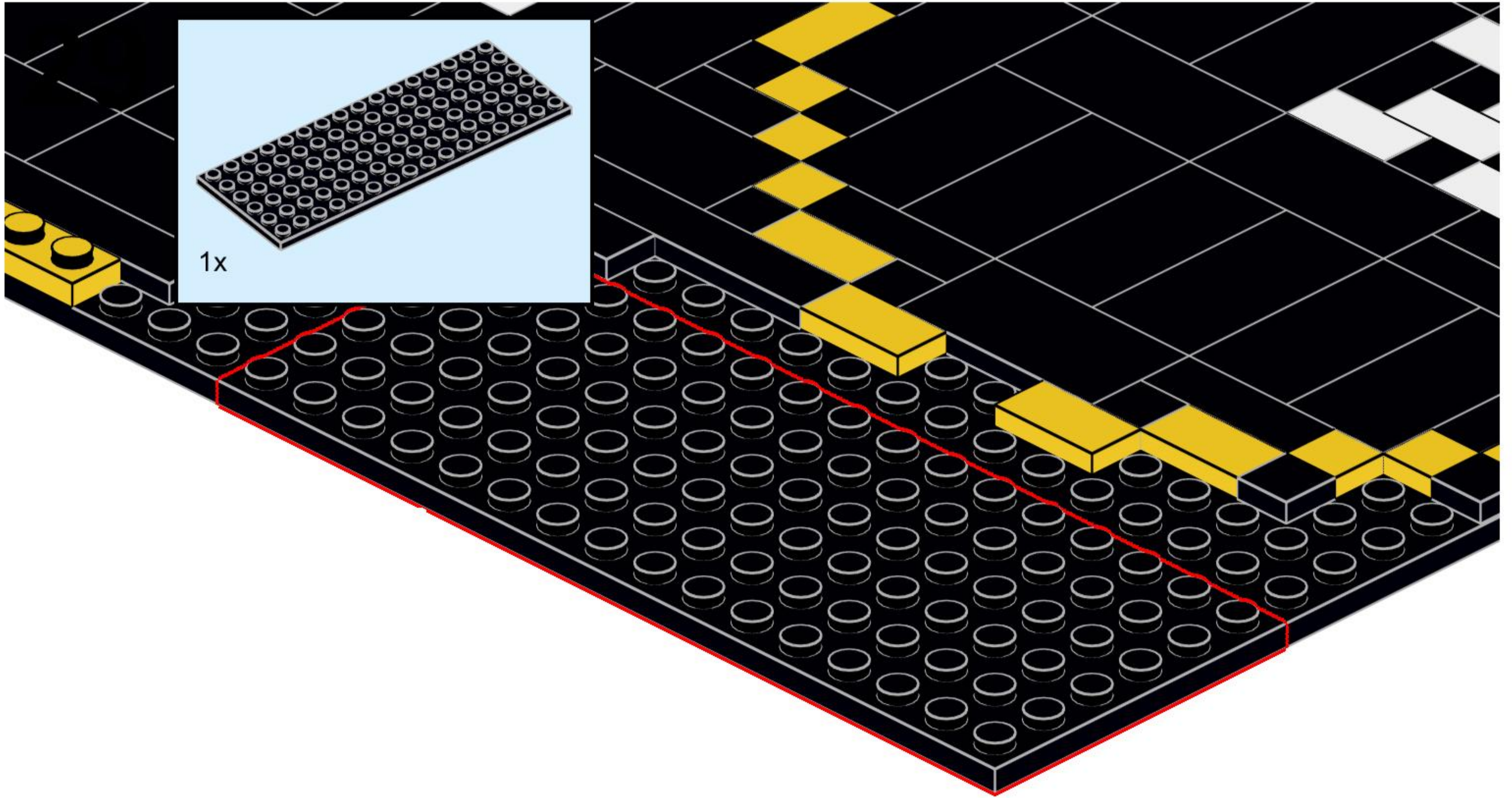

30

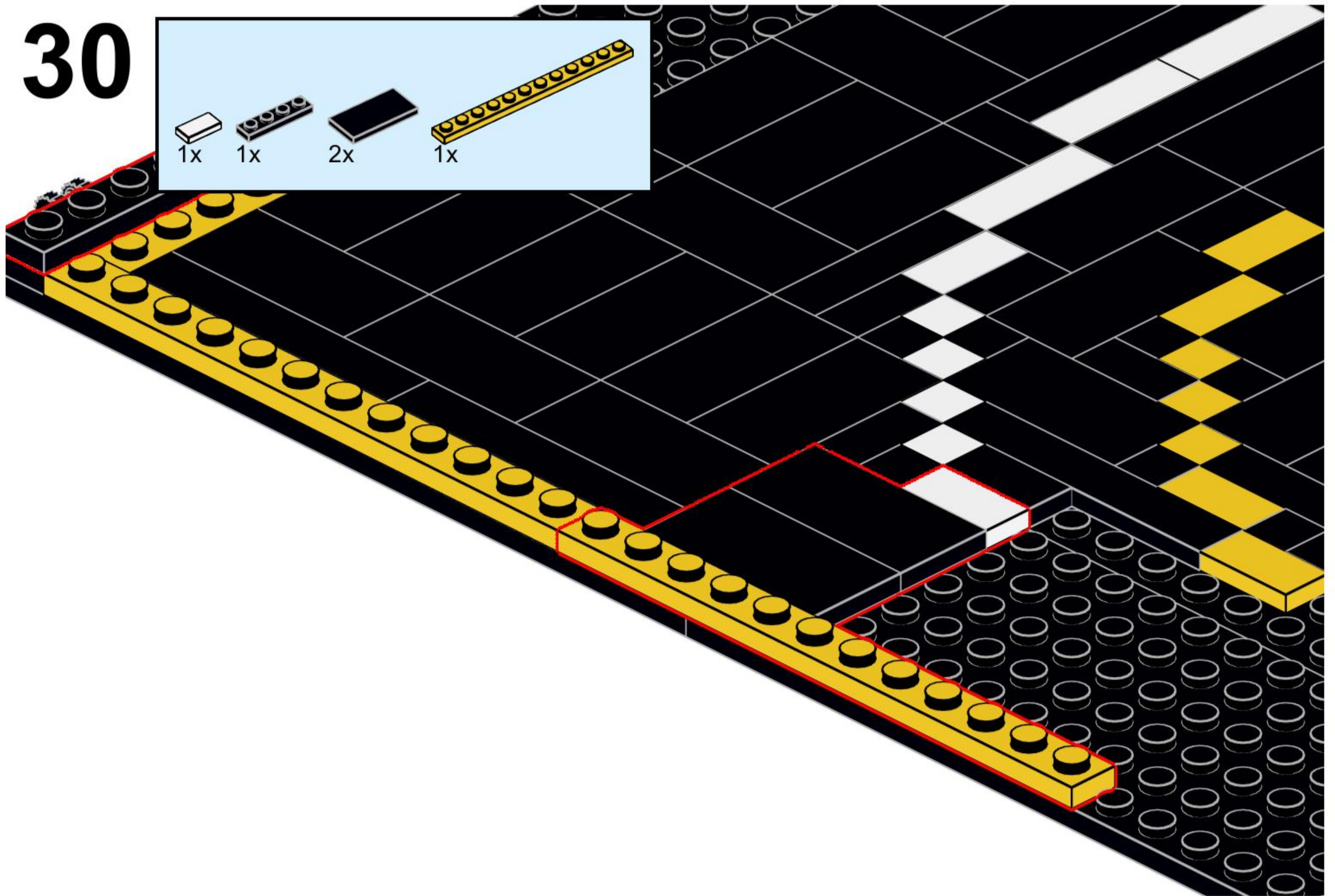
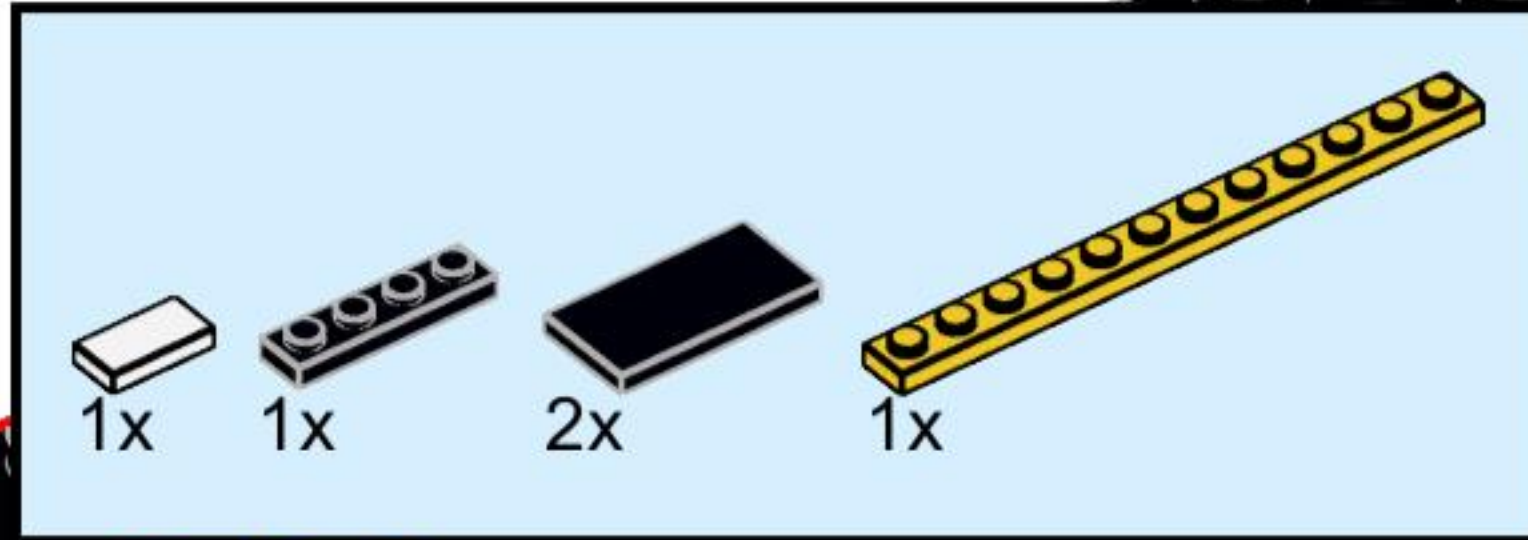

1x 4x

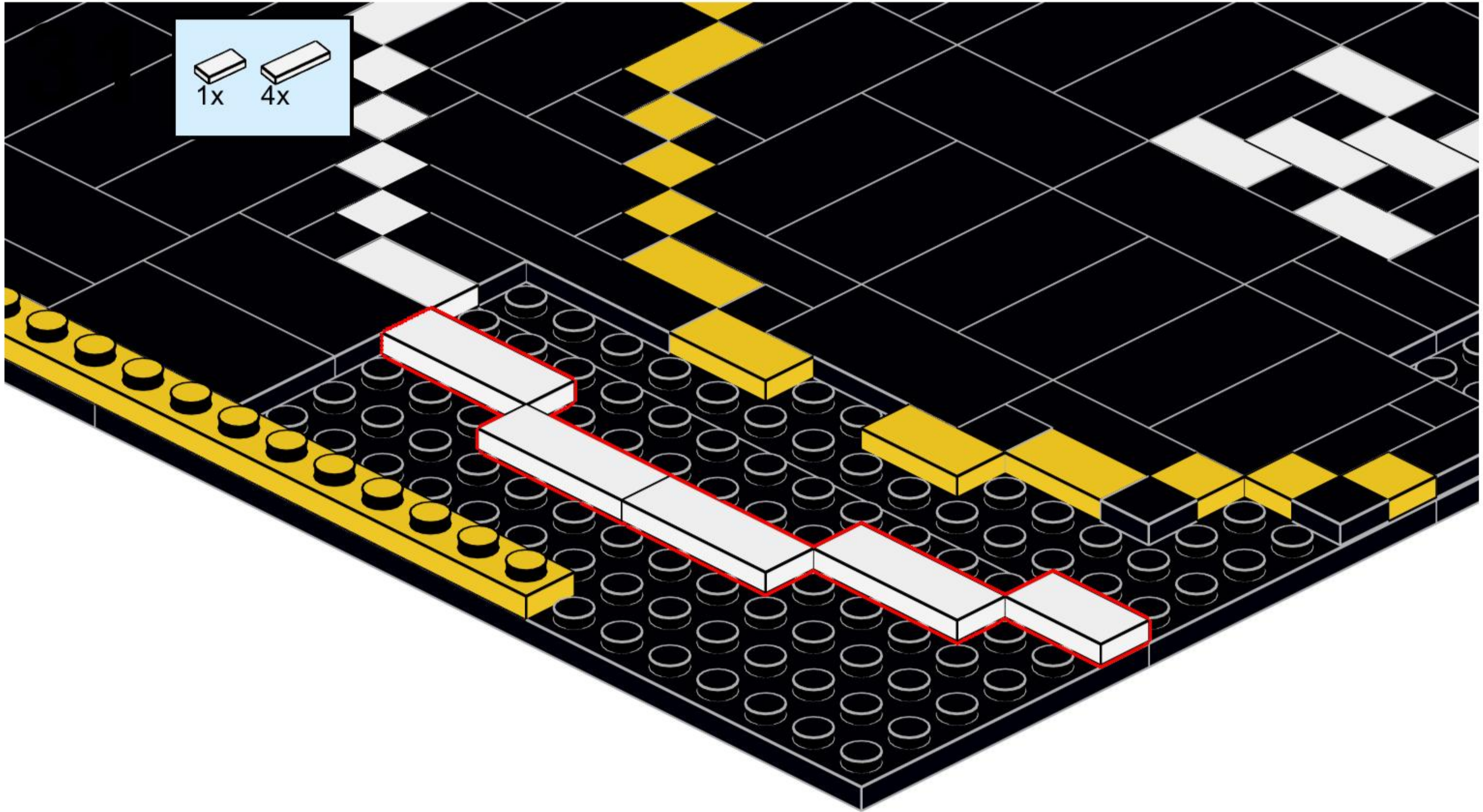

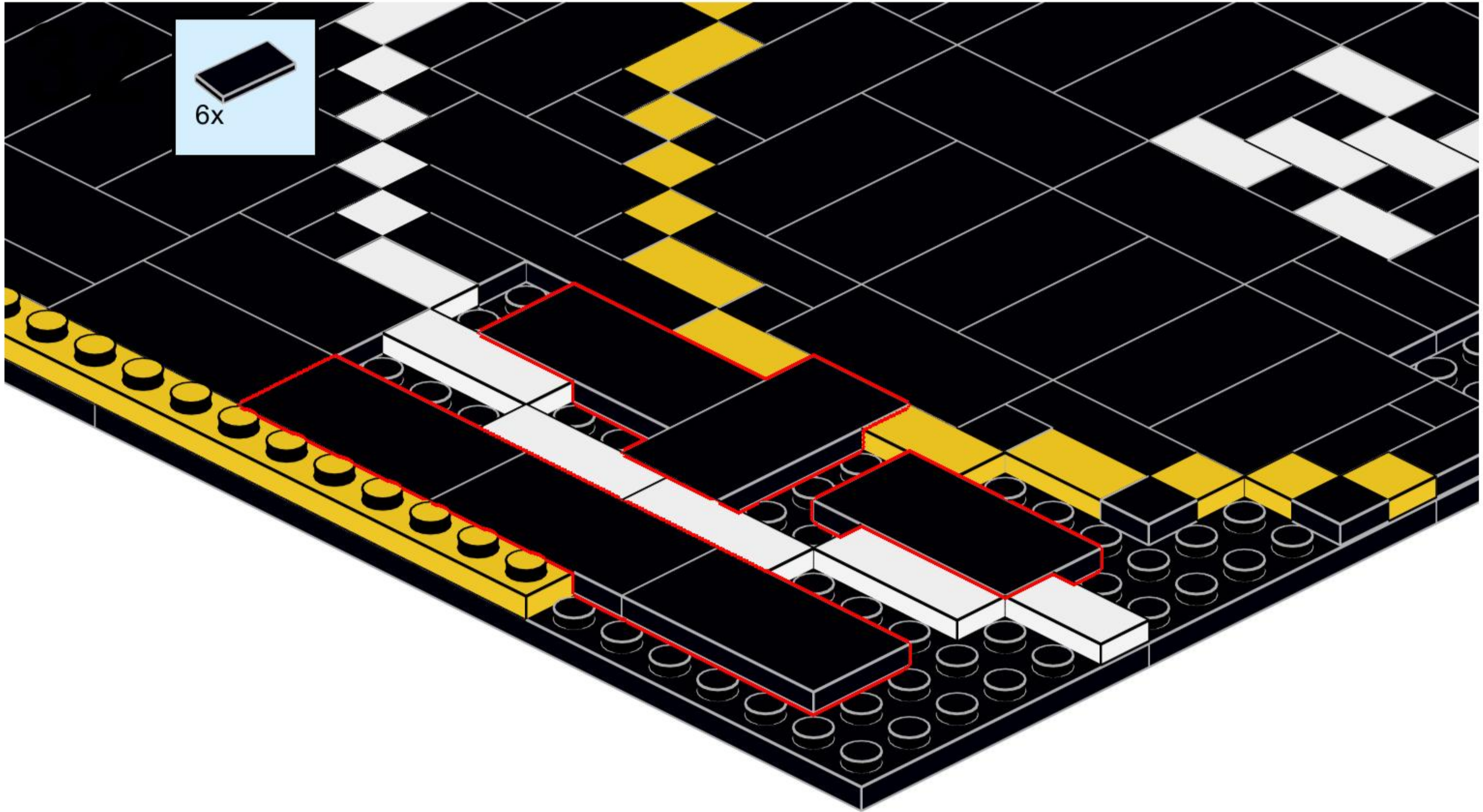
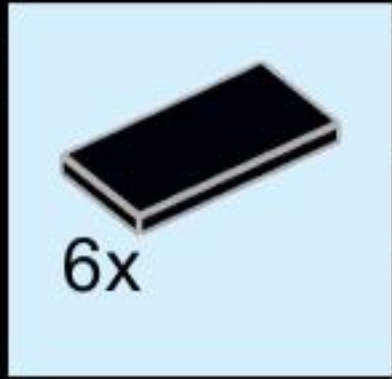

1x 3x 3x

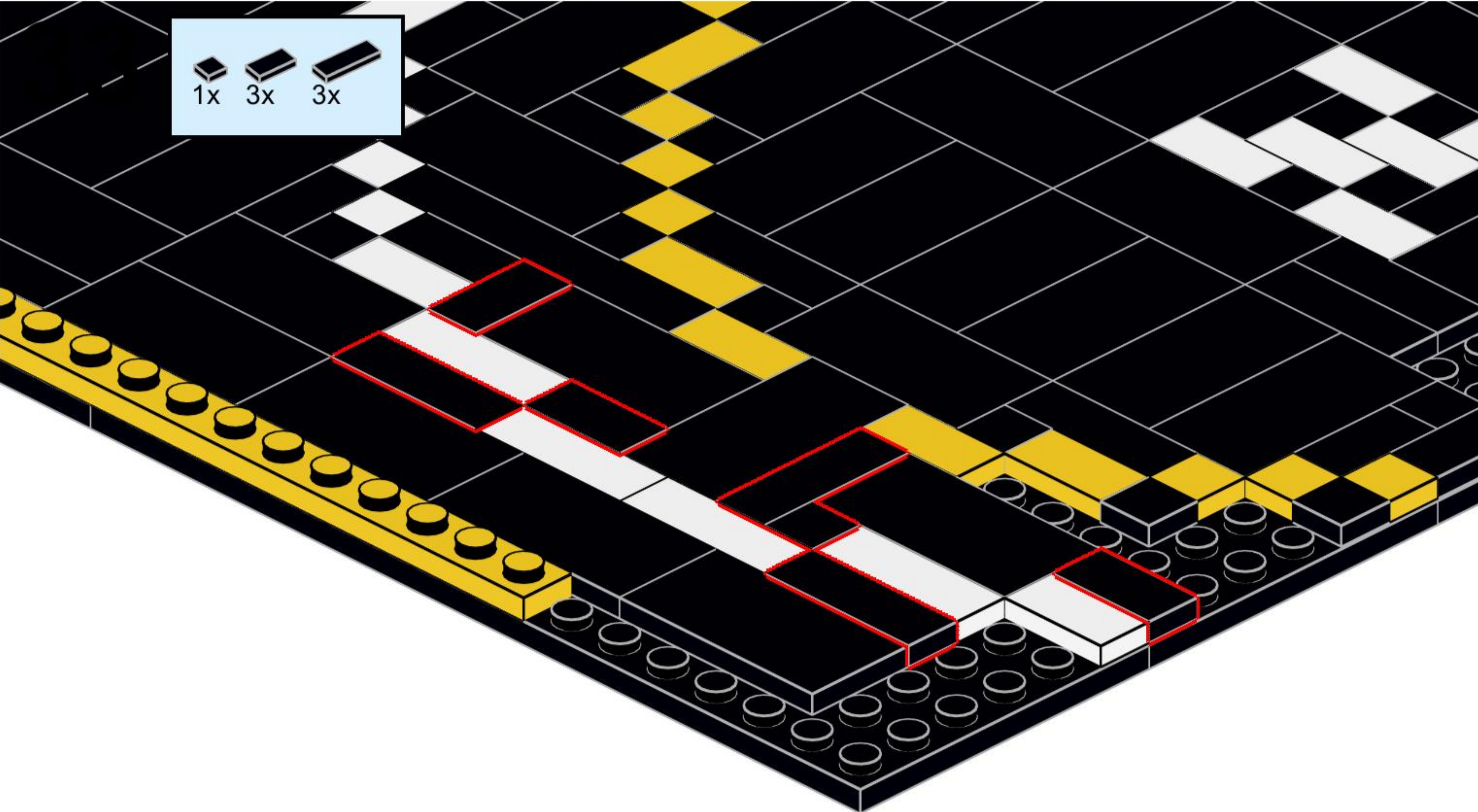

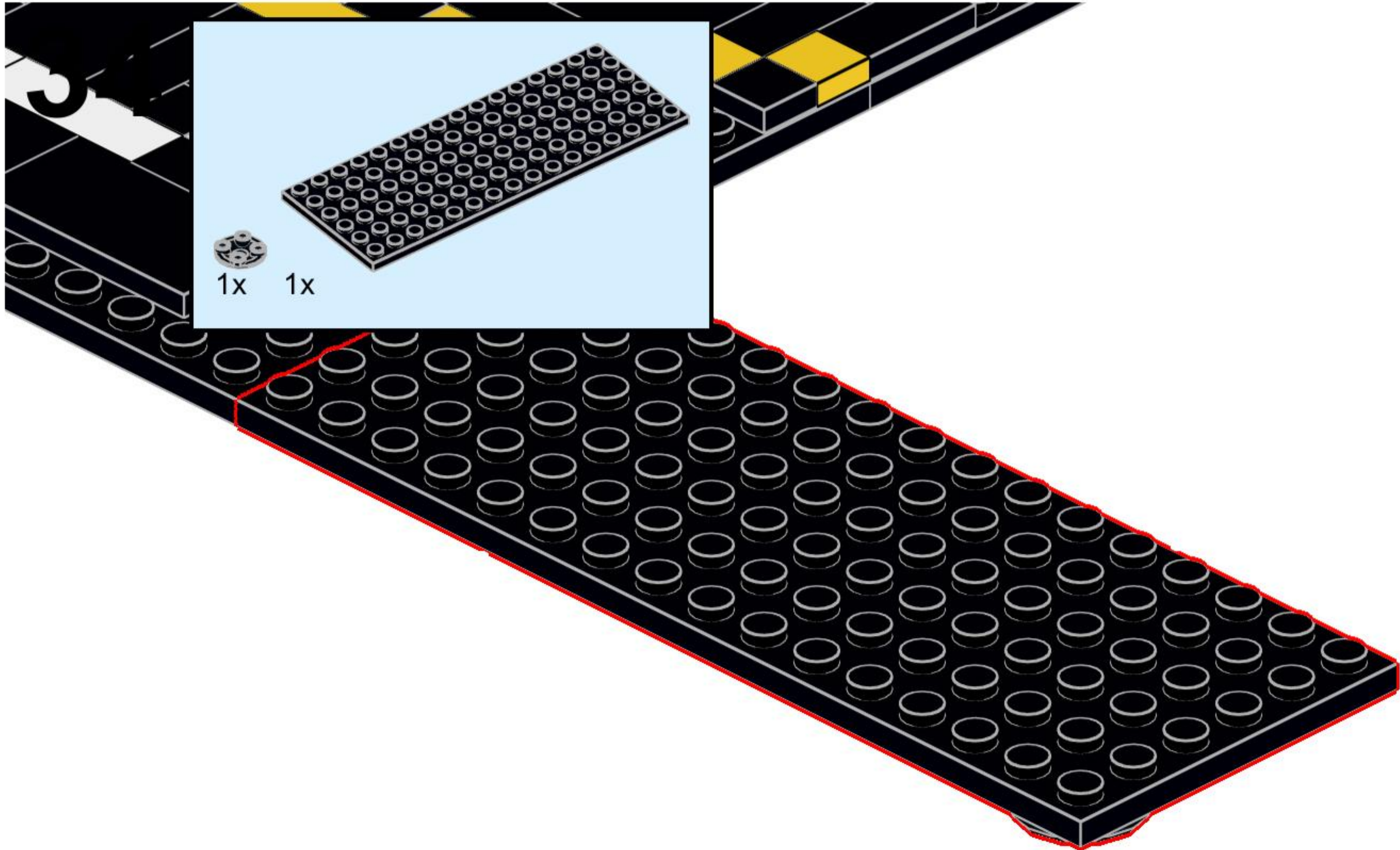

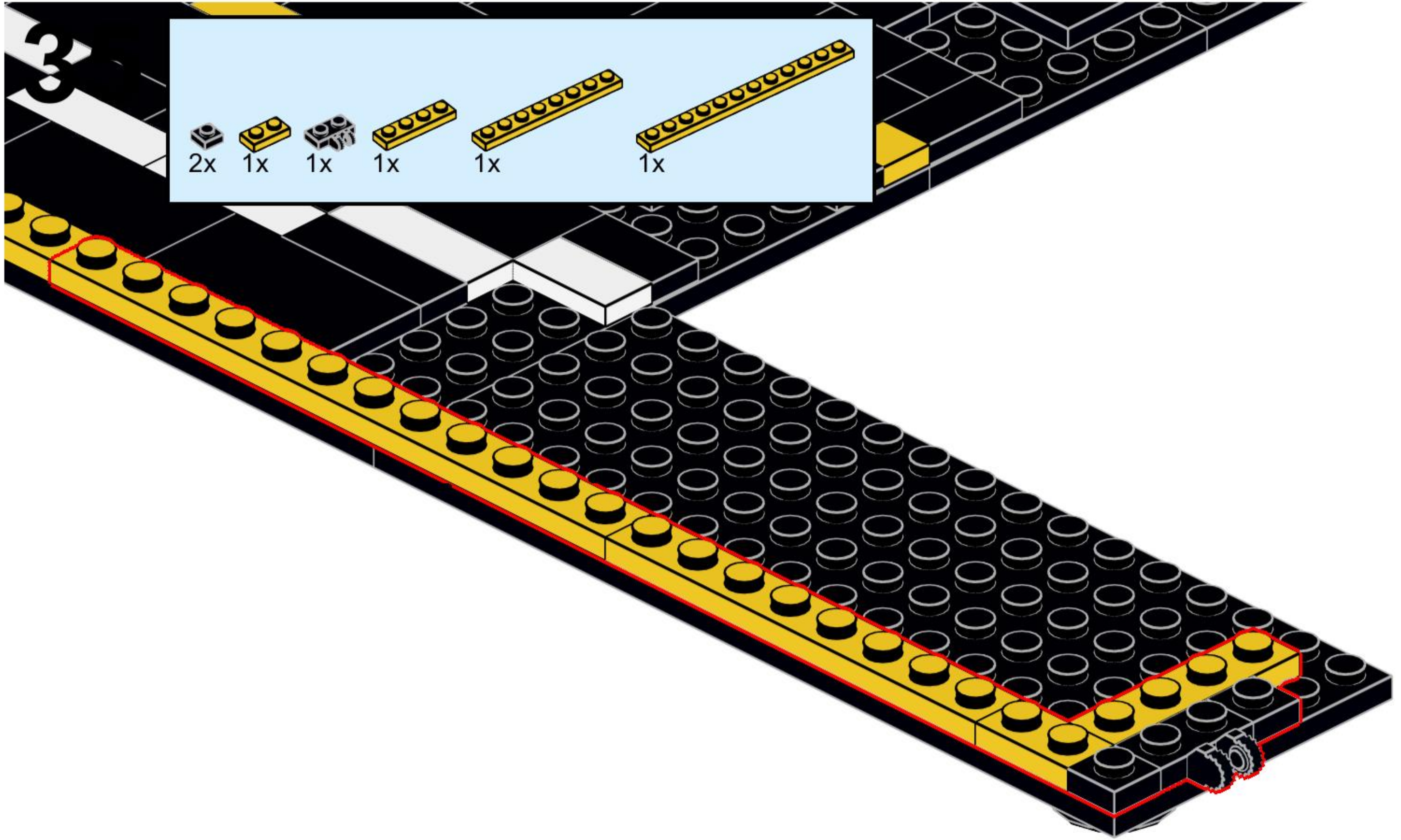

2x 1x 1x 1x 1x 1x

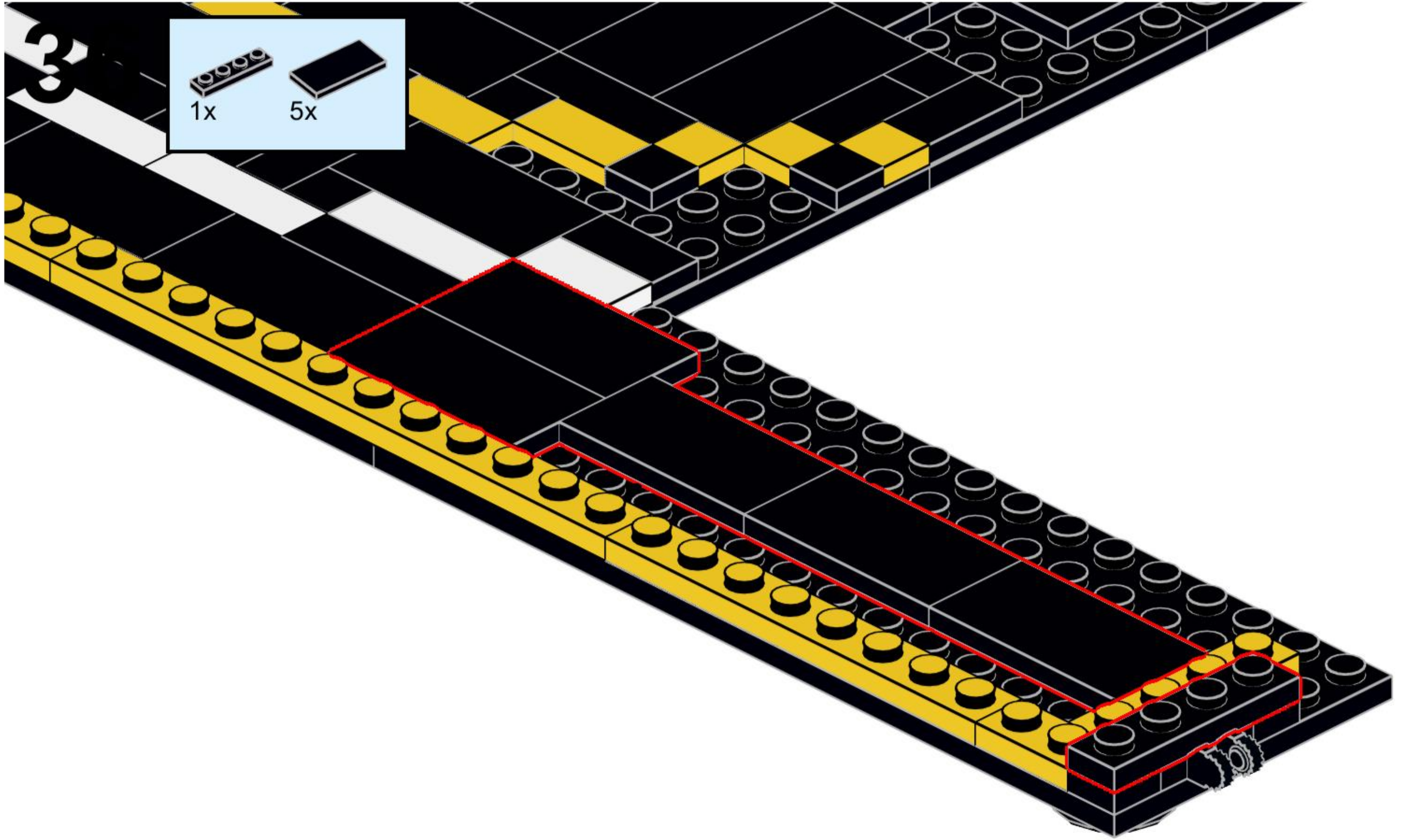

3

1x 5x

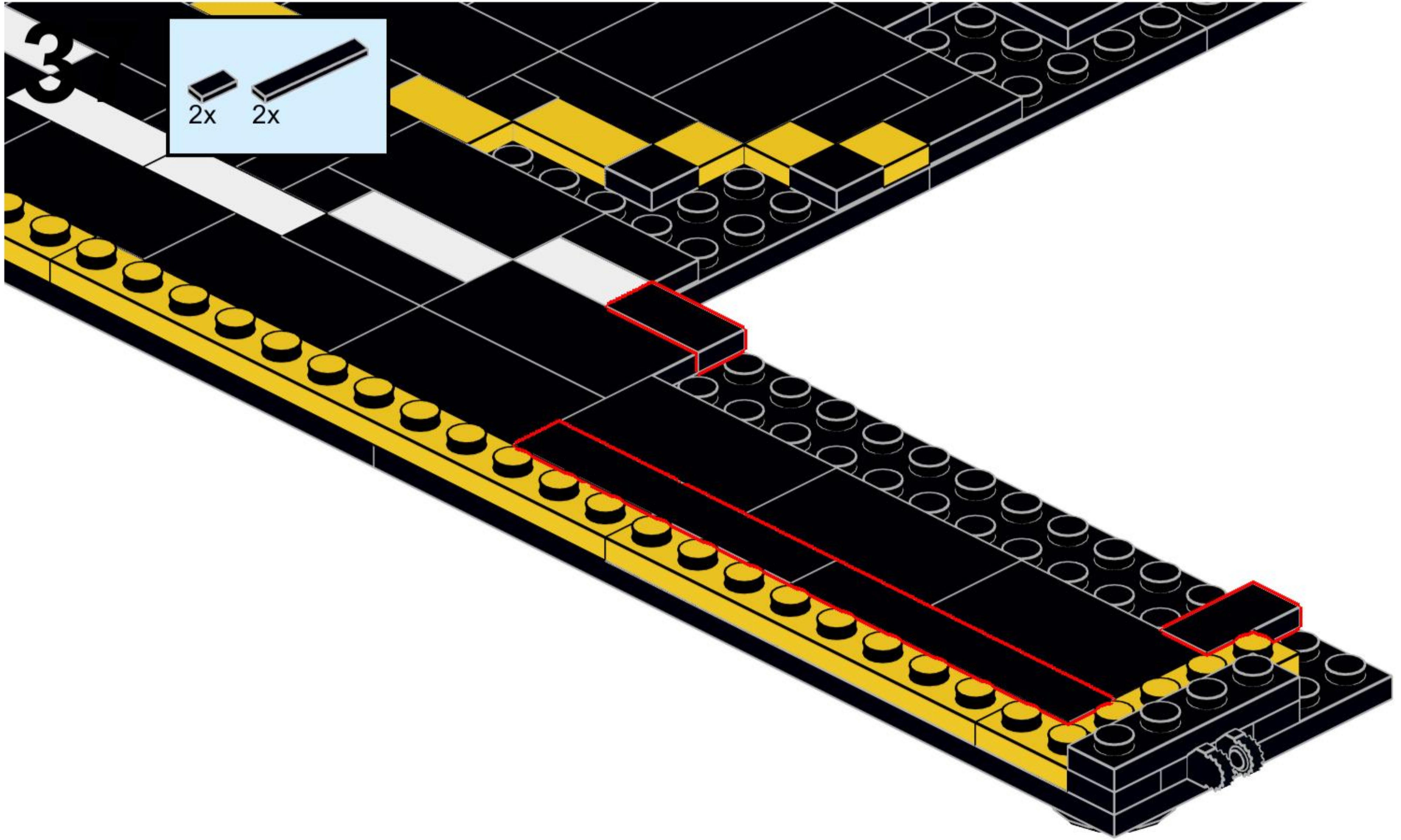

3

2x 2x

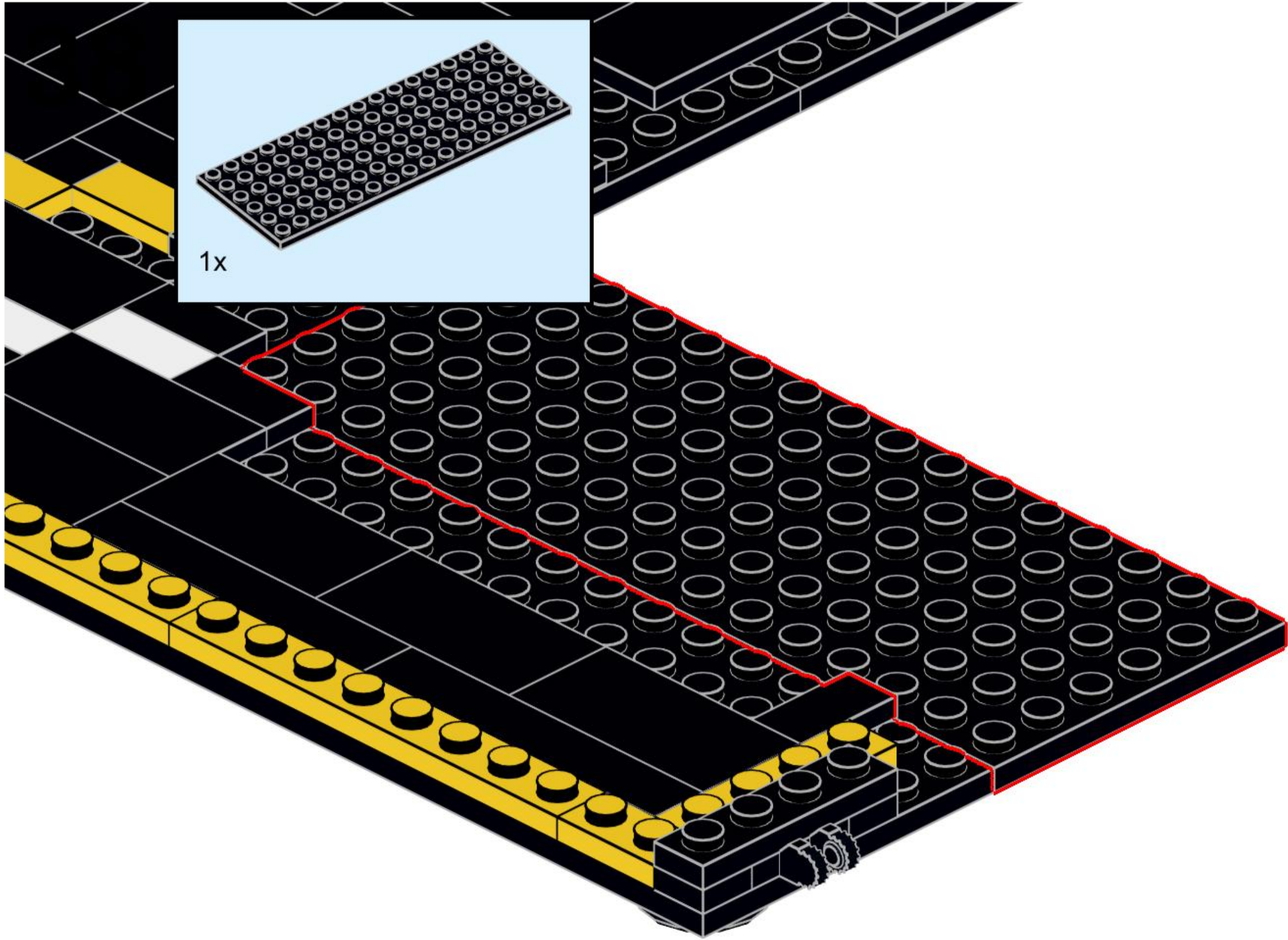

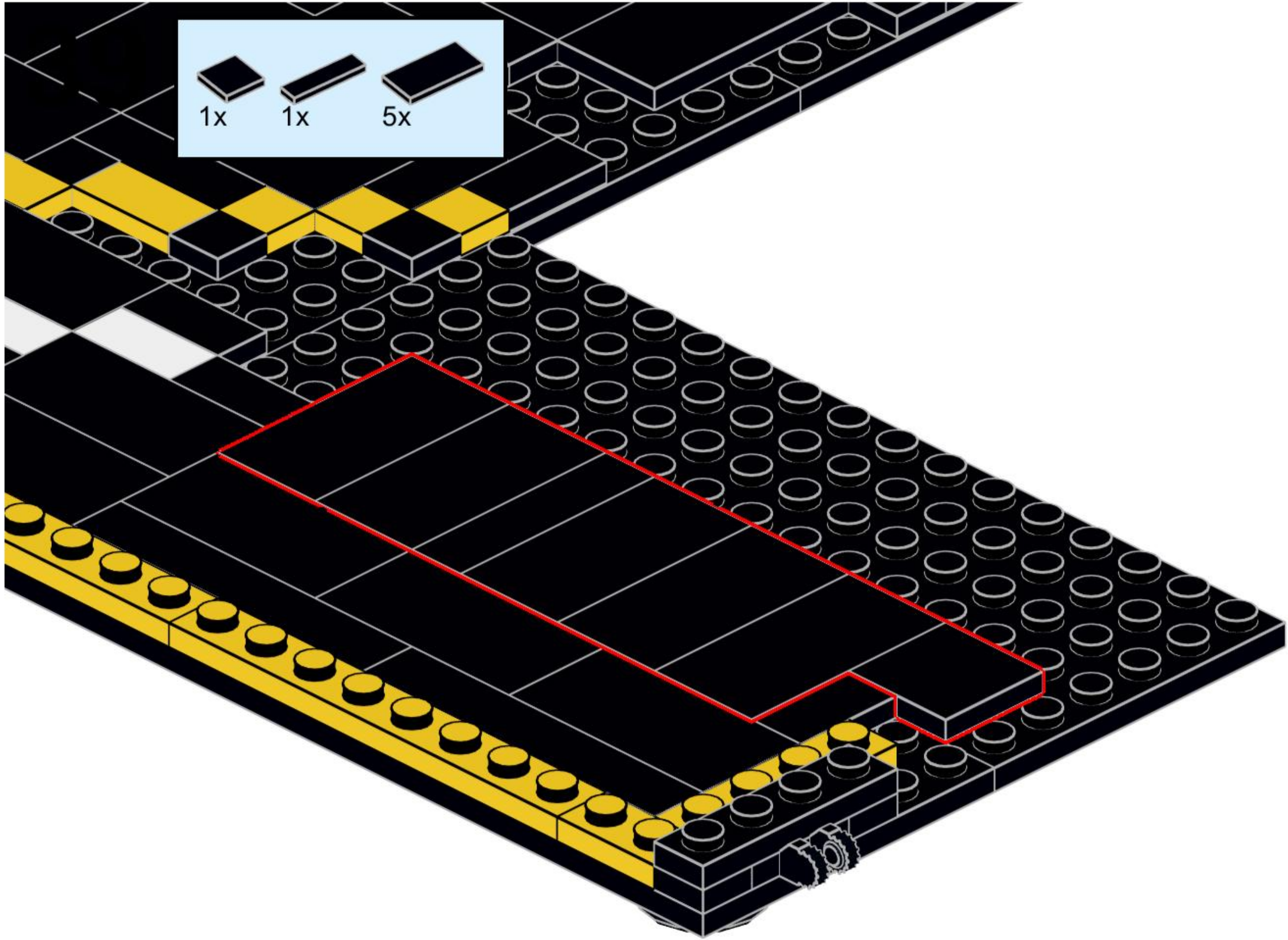



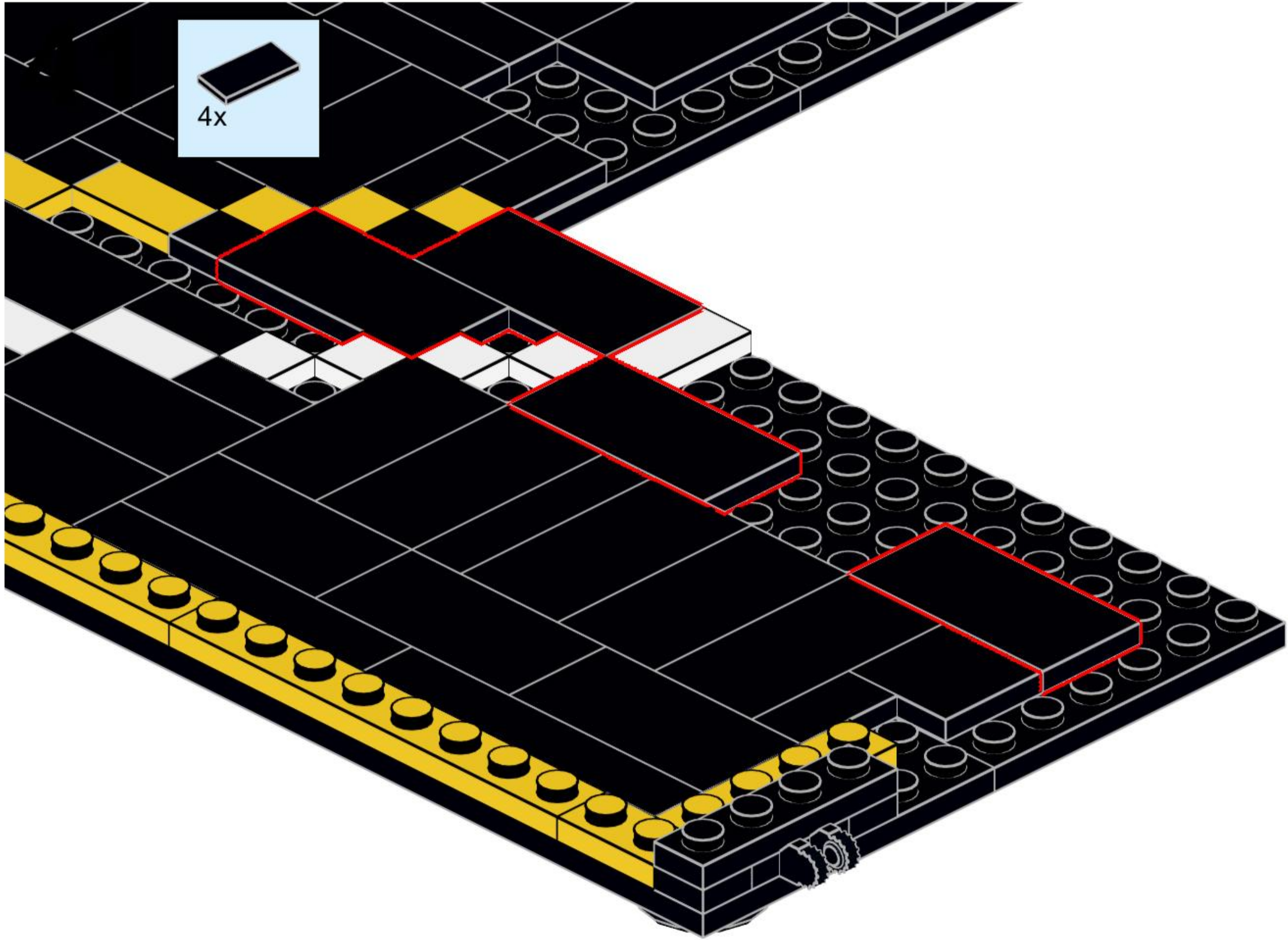
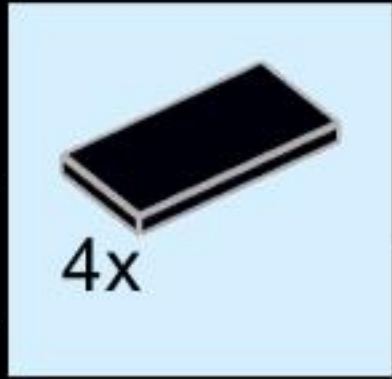

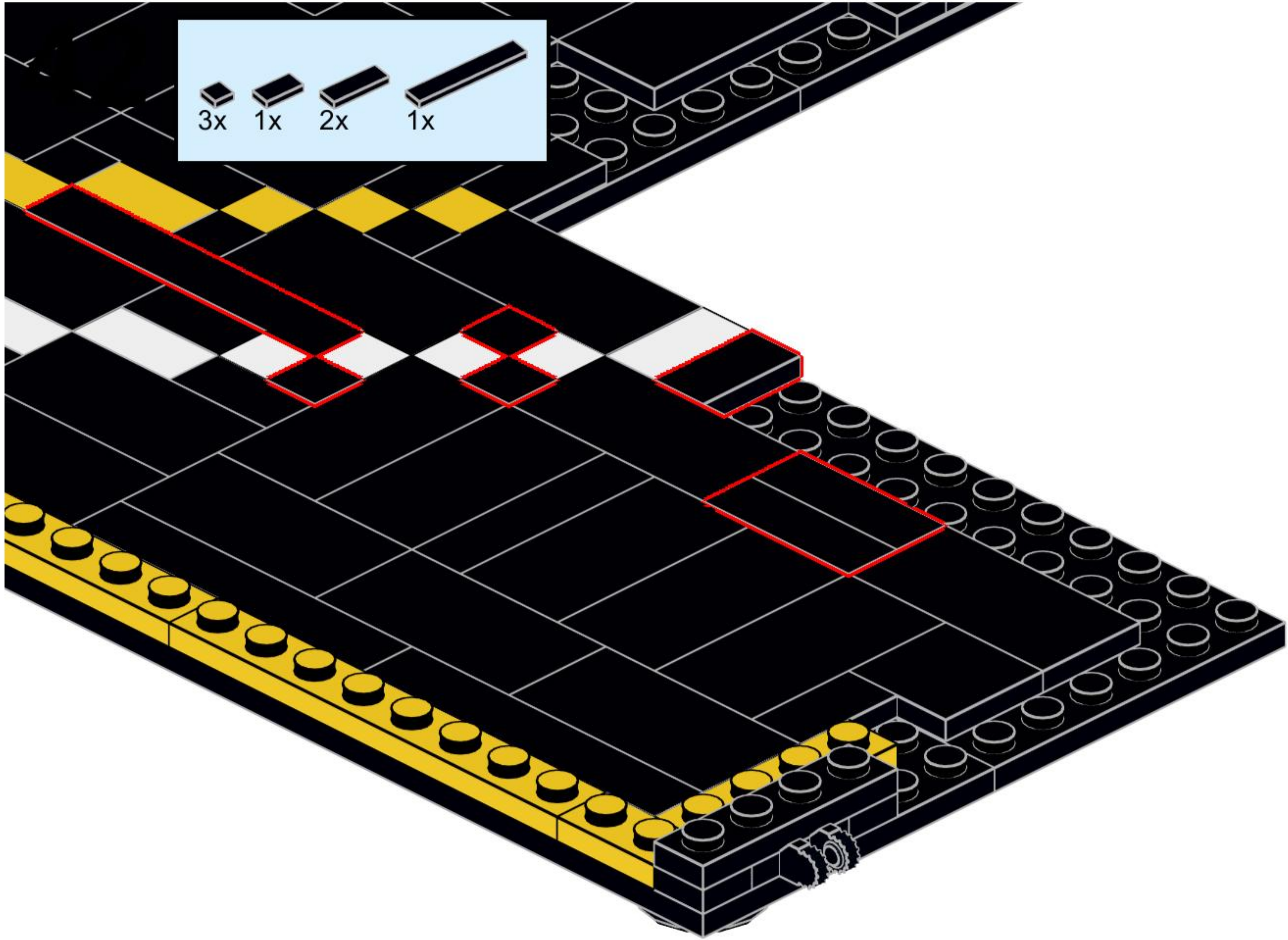
1x 1x 5x





- 3x 
- 1x 
- 2x 
- 1x 

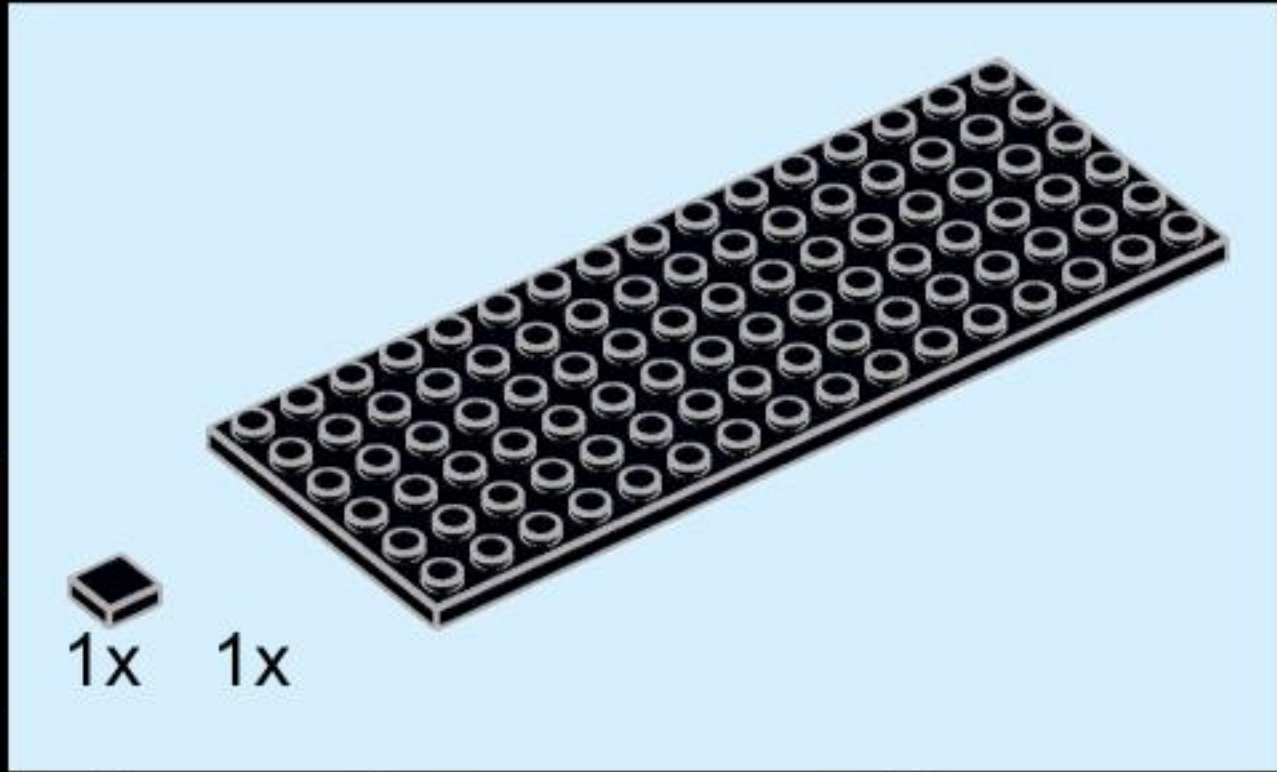
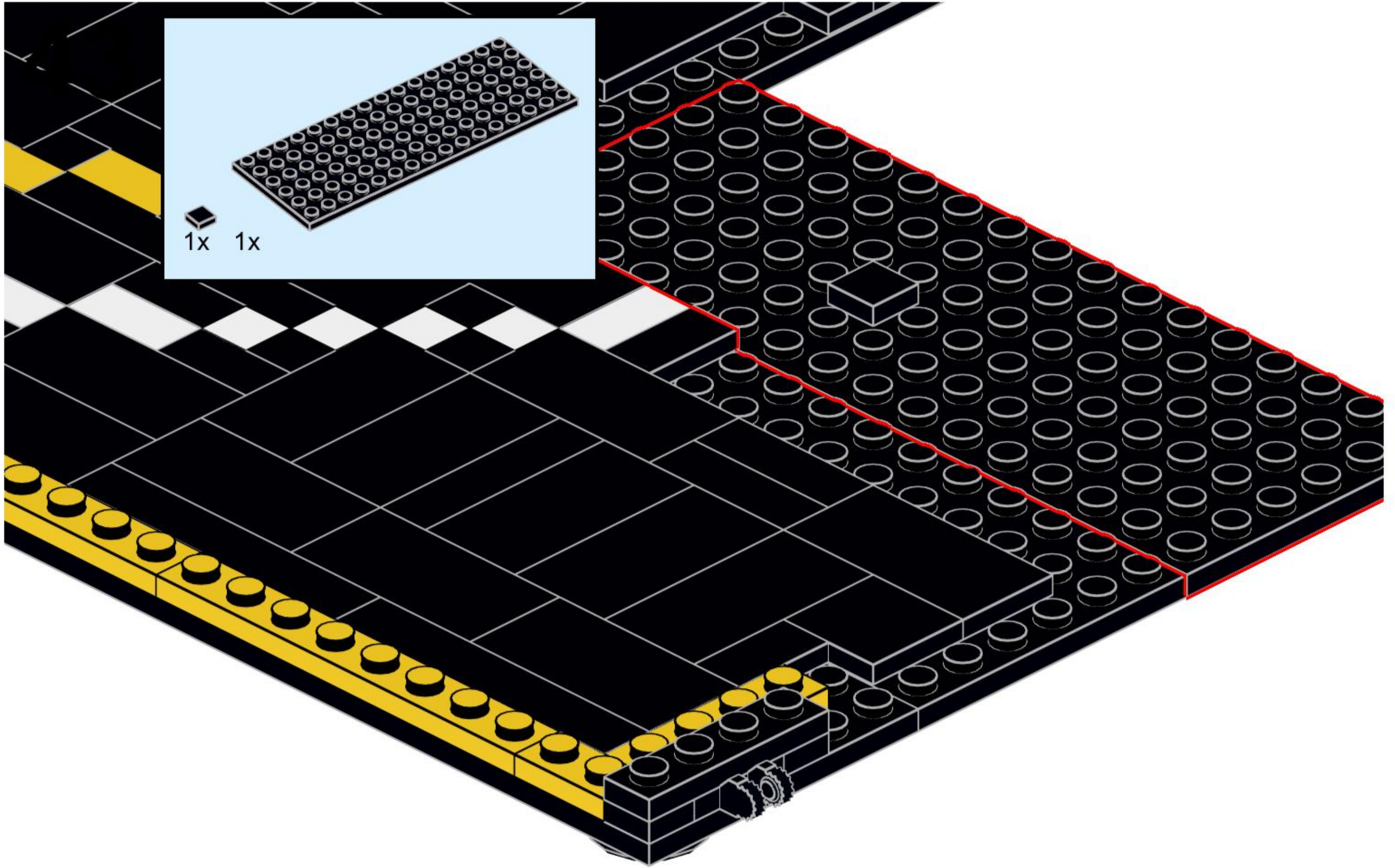

2x 2x 2x

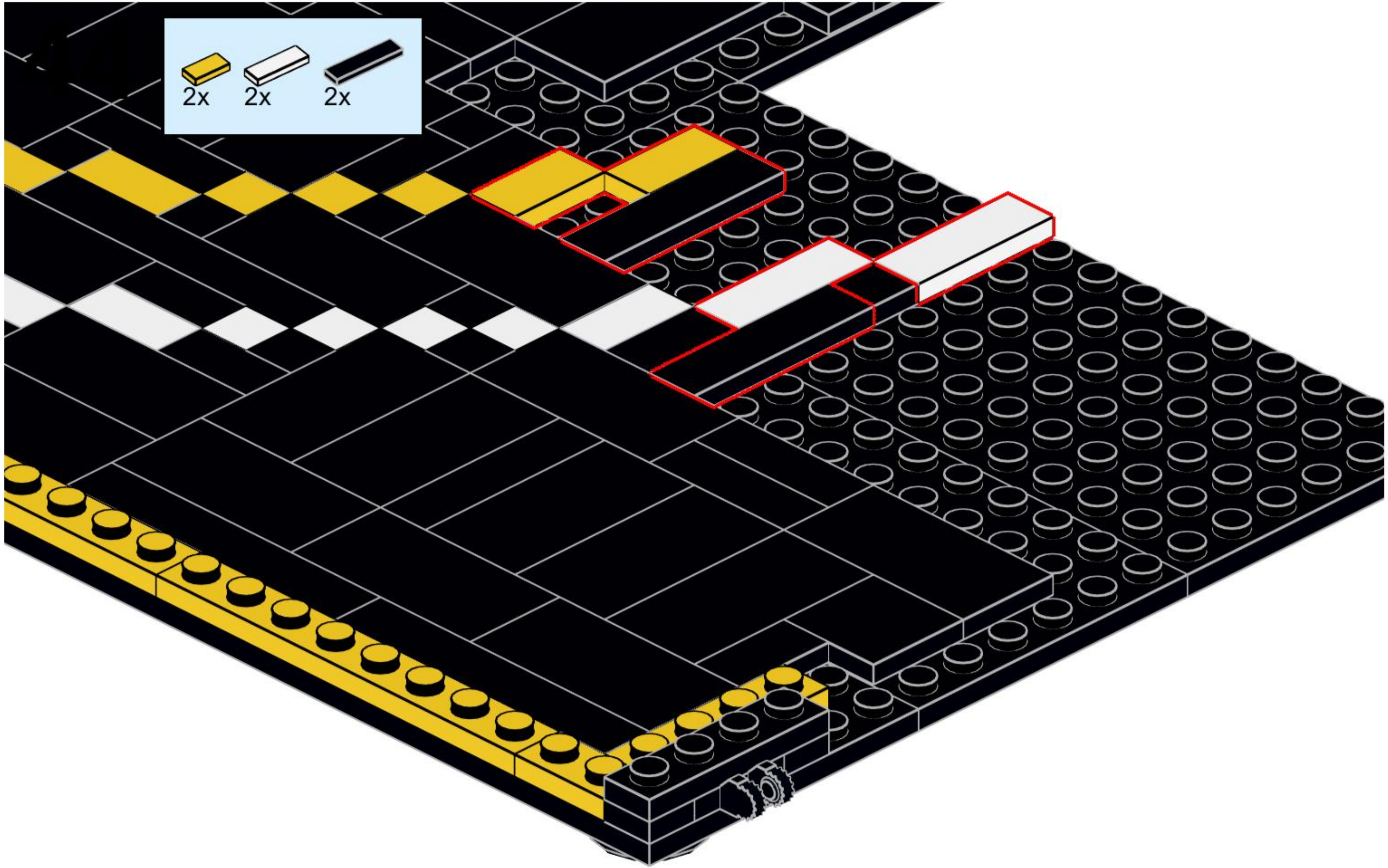

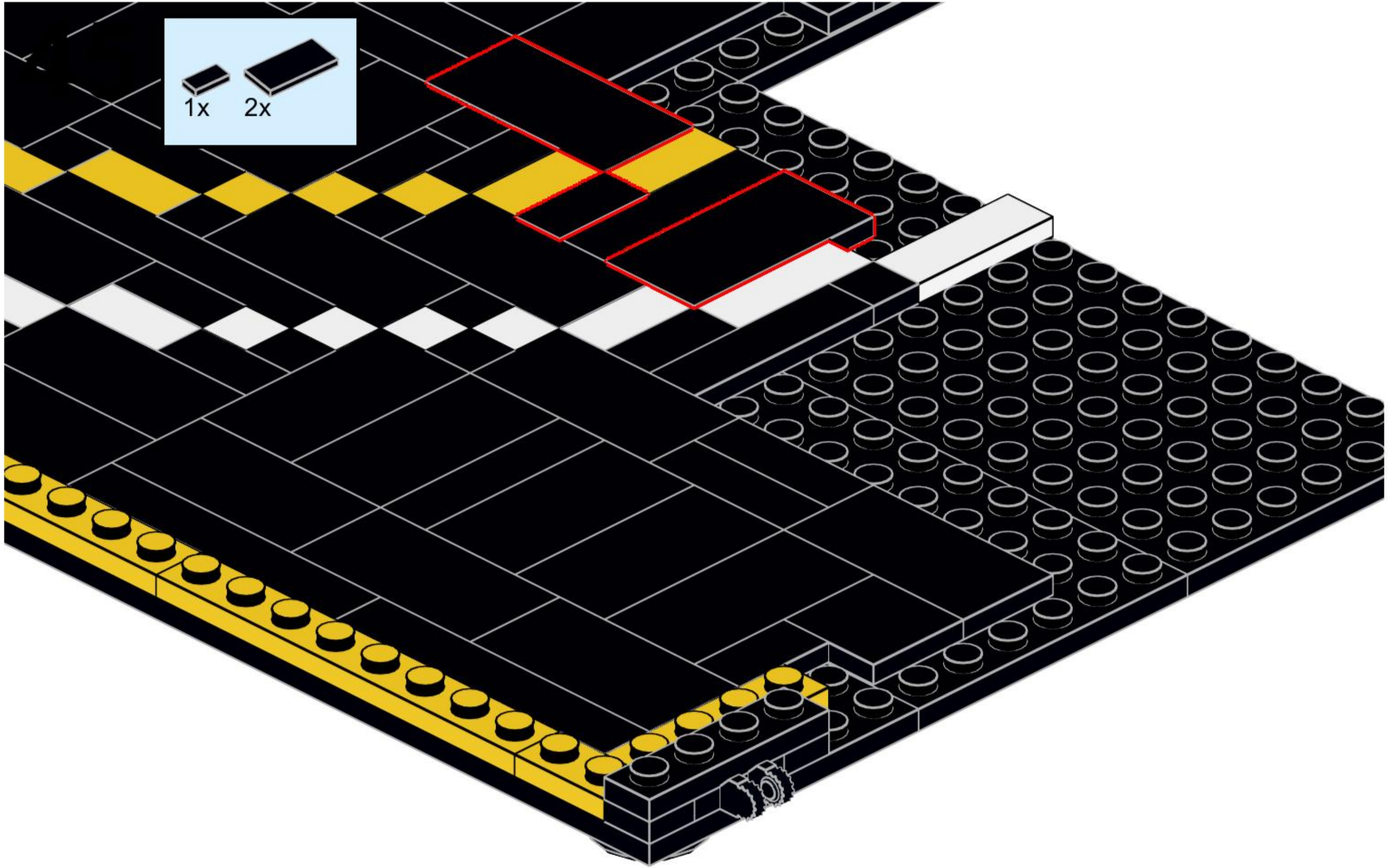

1x 2x

A light blue rectangular box containing a parts list. On the left, there is a small black 1x Technic beam with the text "1x" below it. On the right, there is a small black 2x Technic beam with the text "2x" below it.

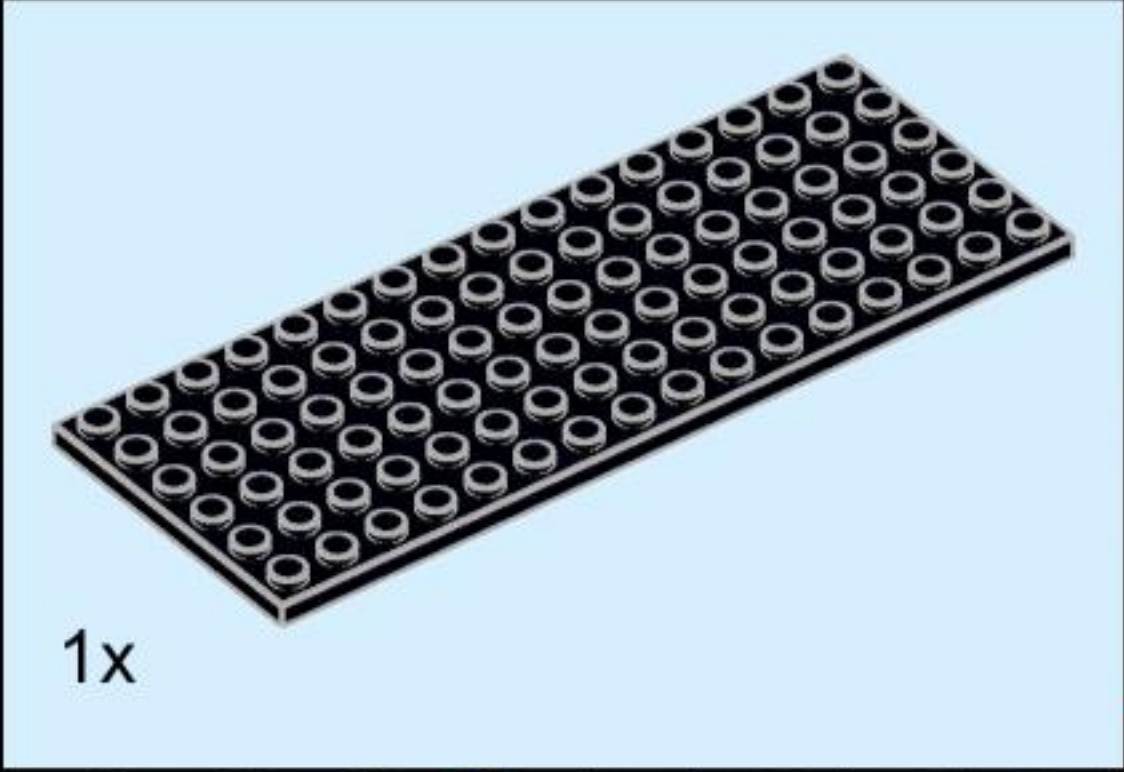
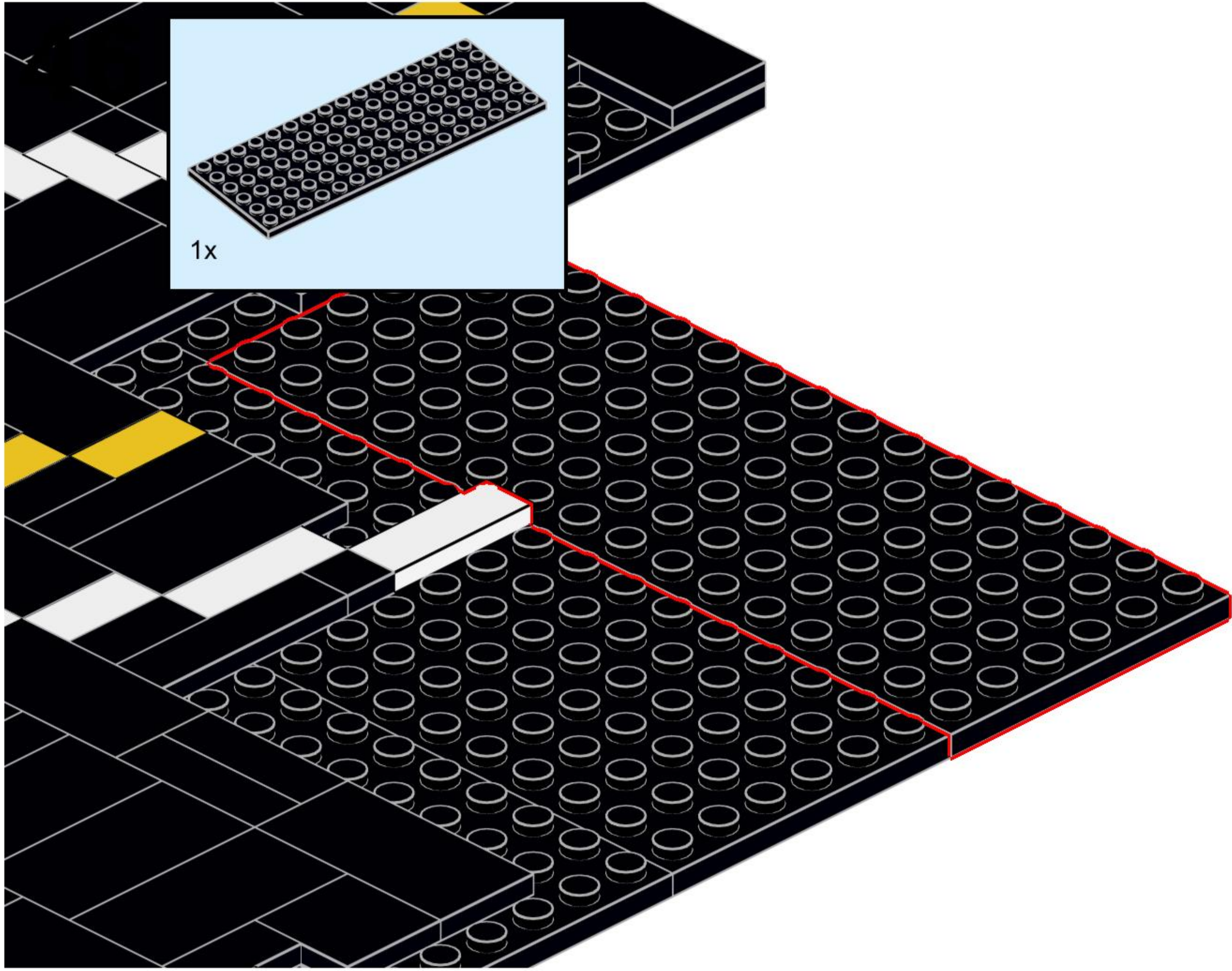

1x

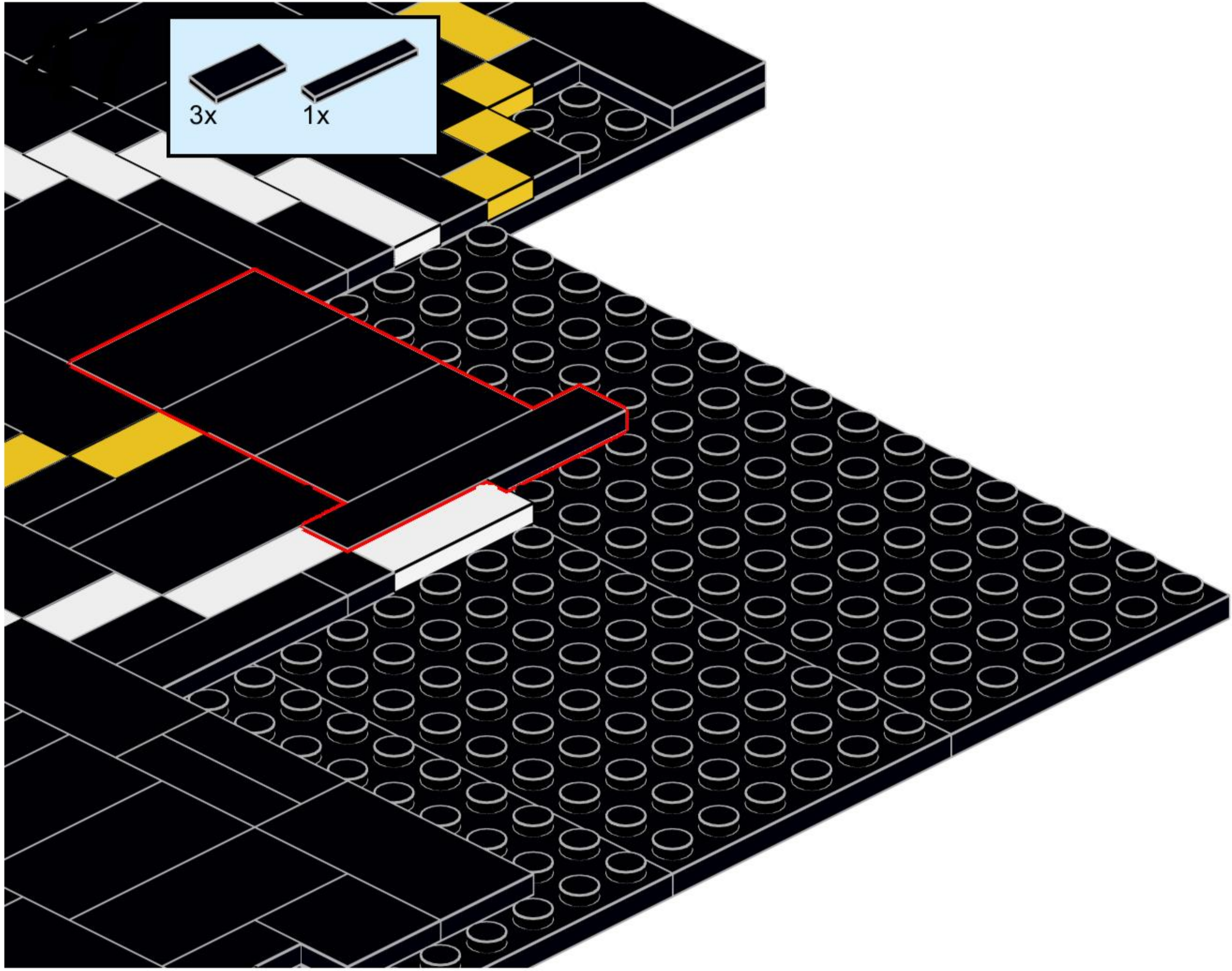

3x 1x

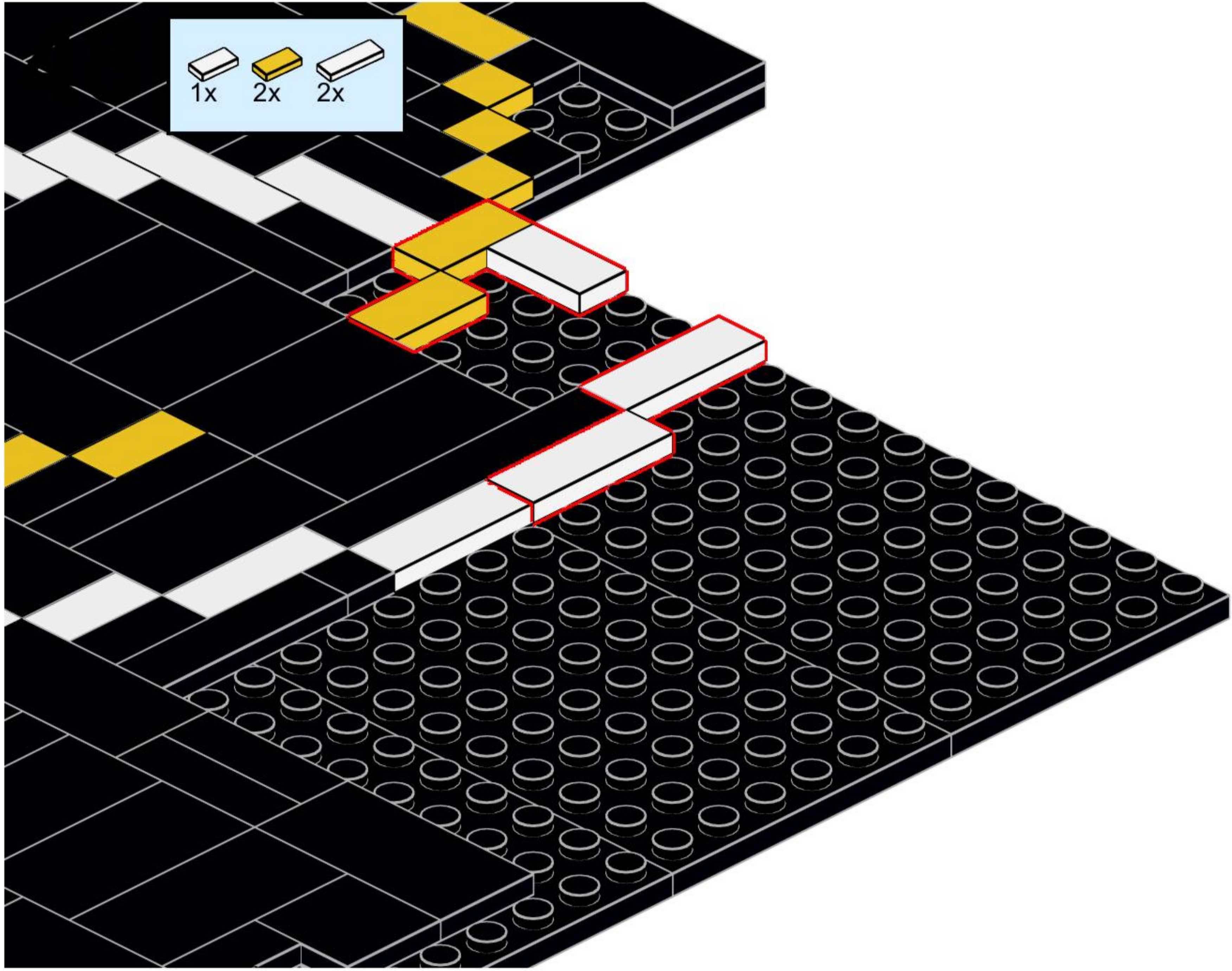

1x 2x 2x

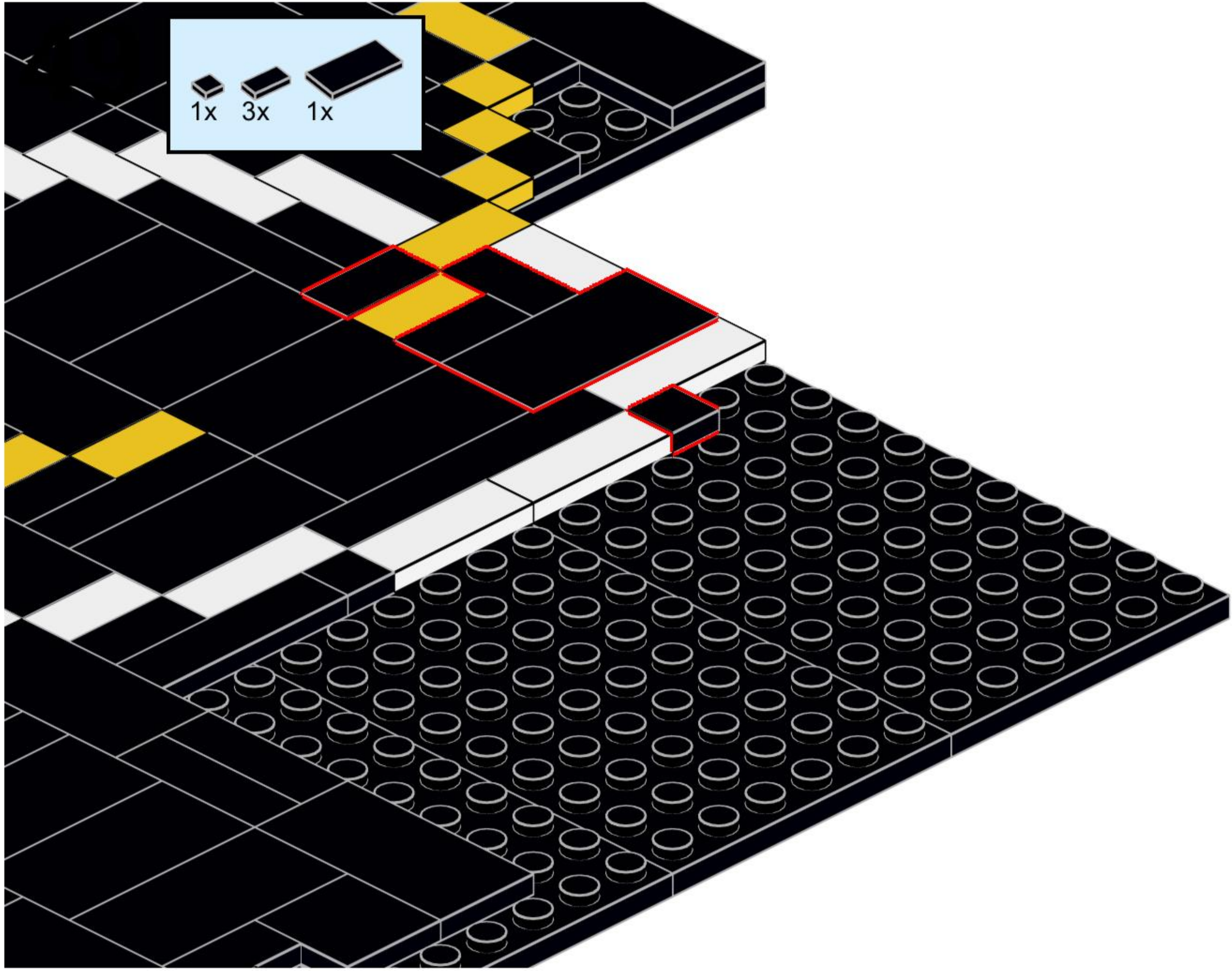

1x 3x 1x

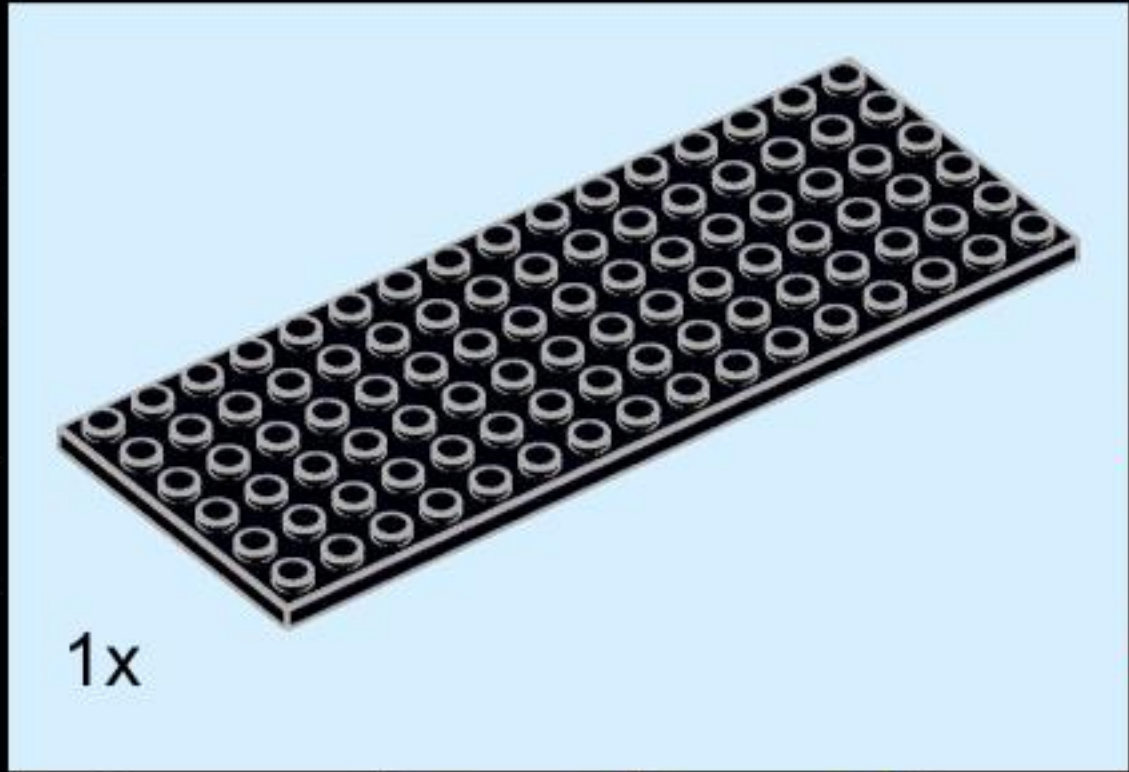
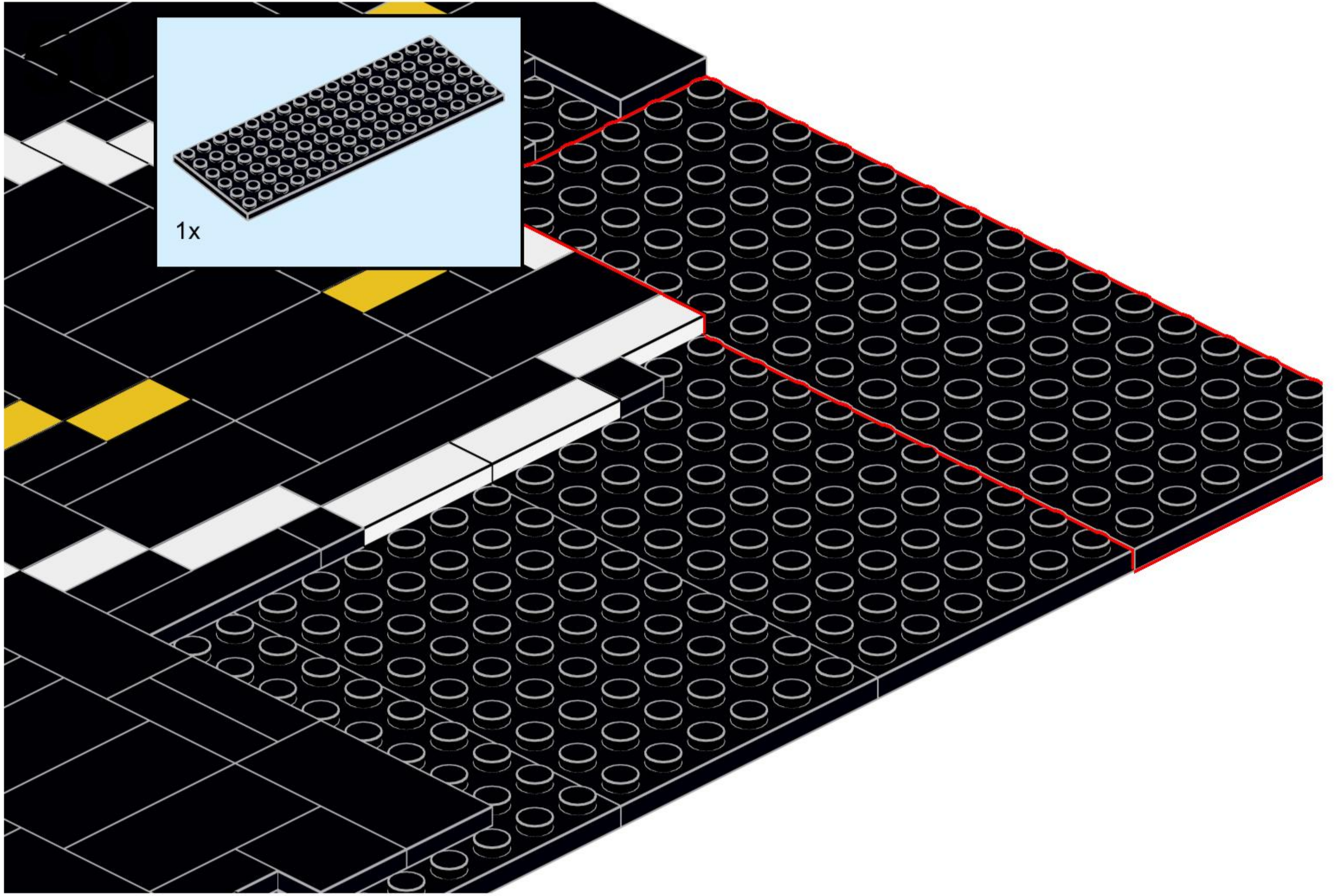

1x

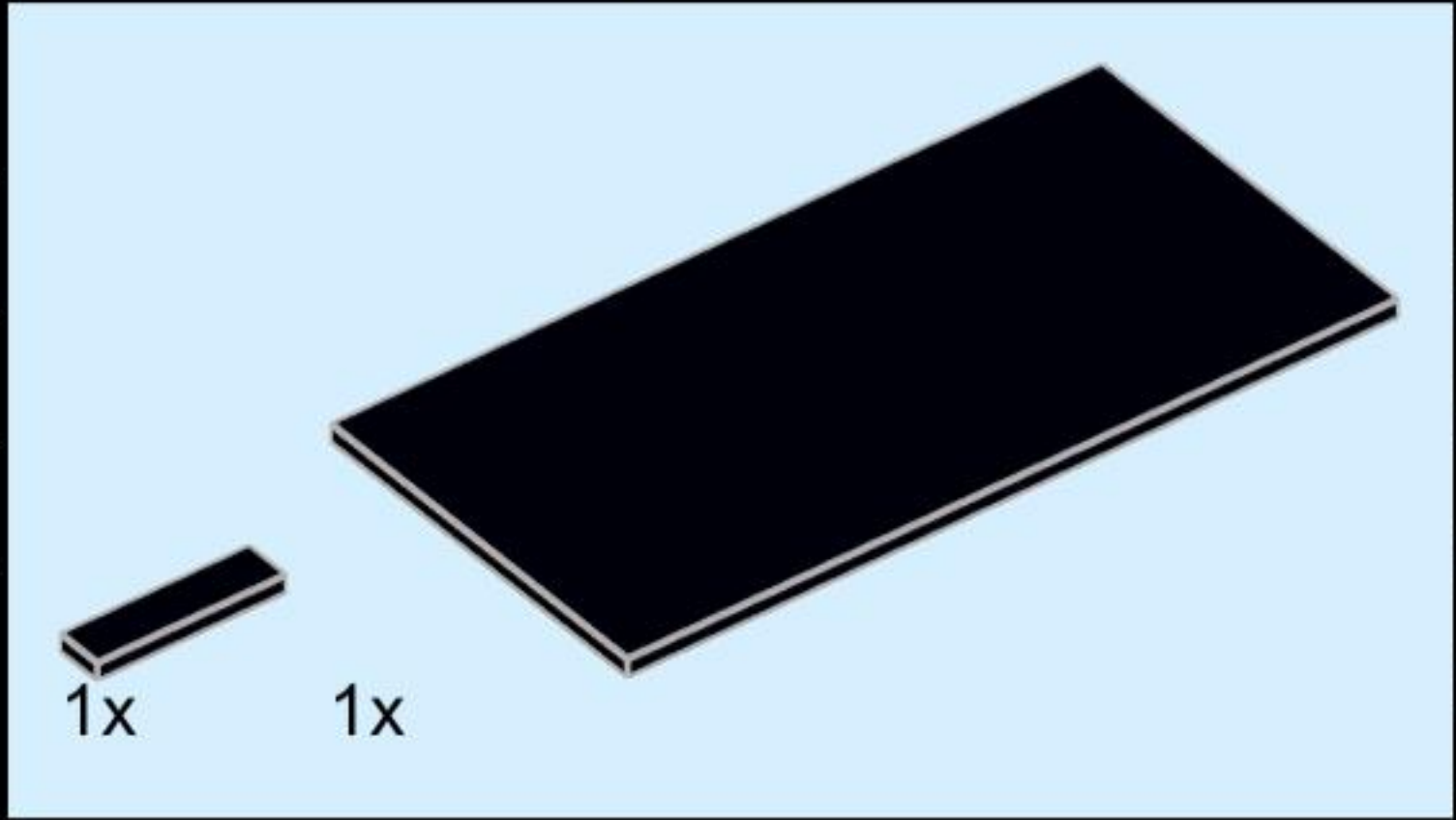
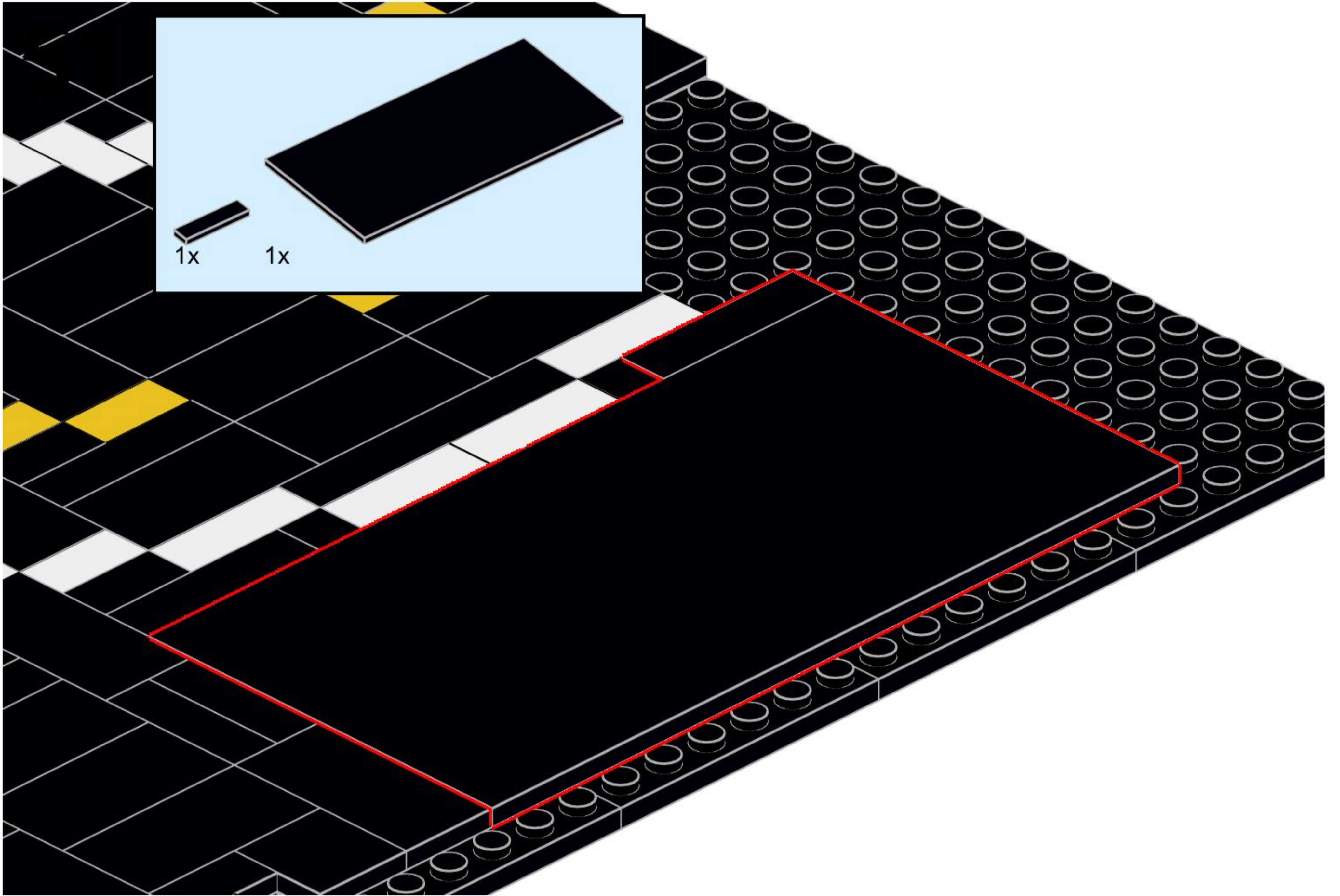

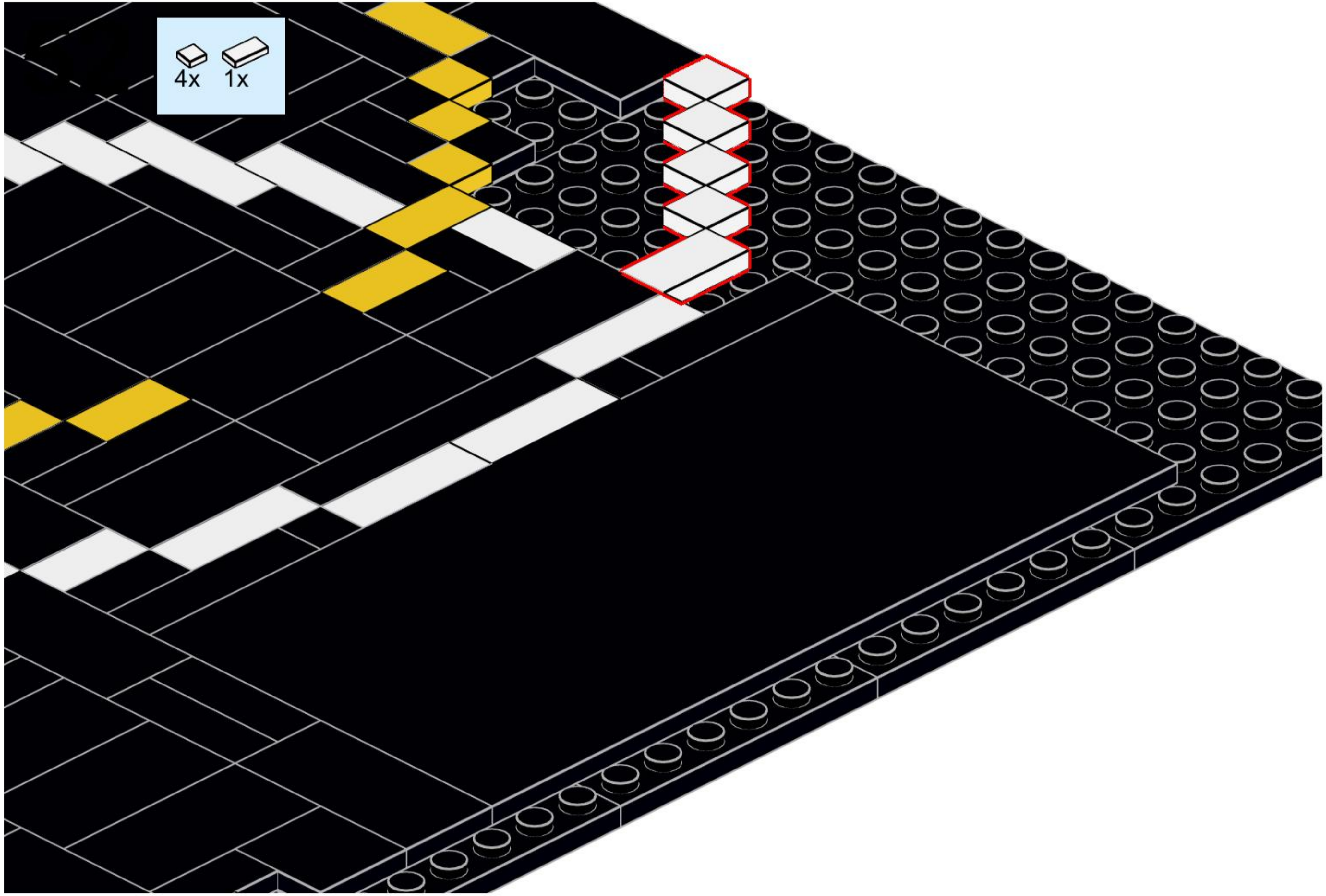

4x 1x

4x 3x

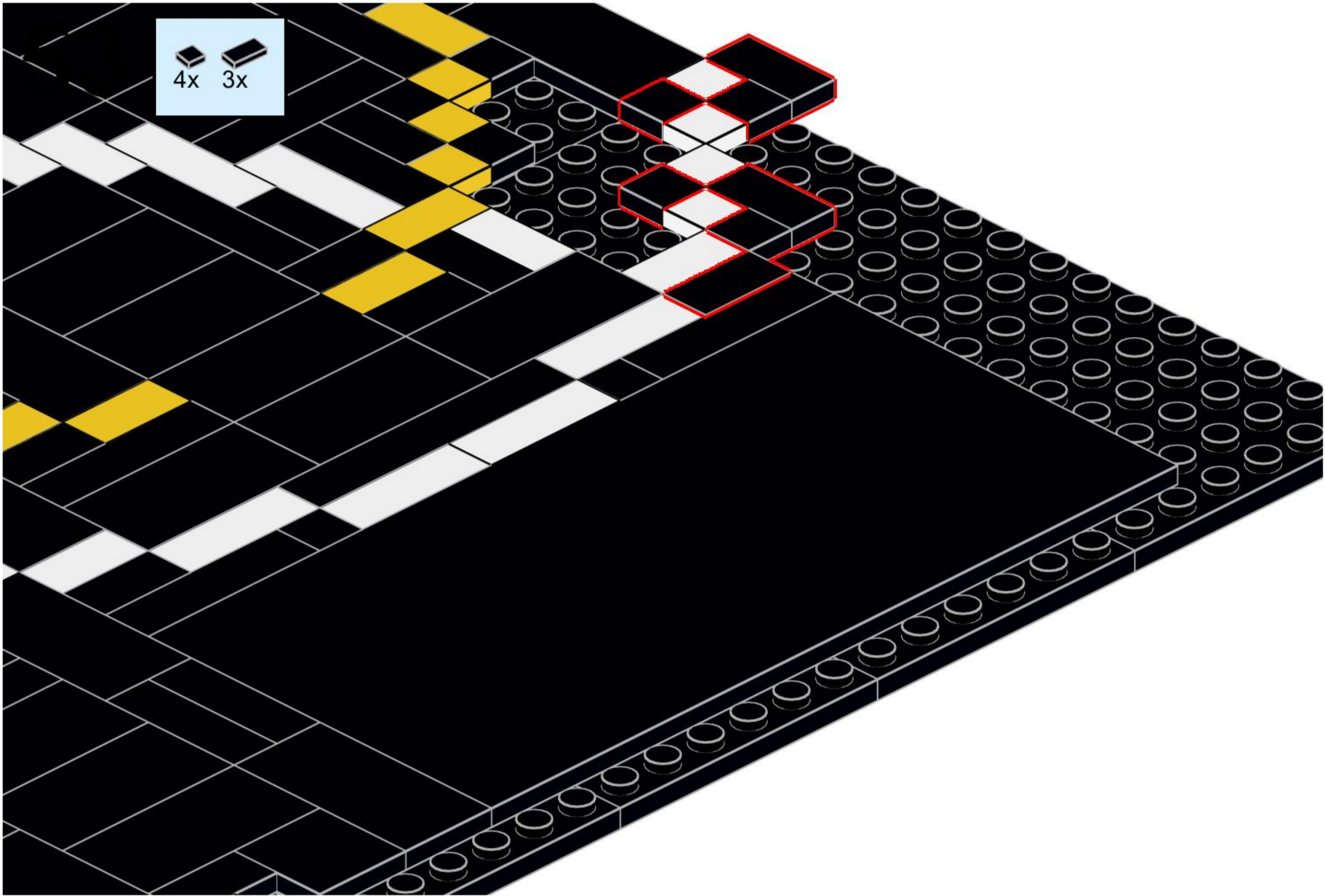

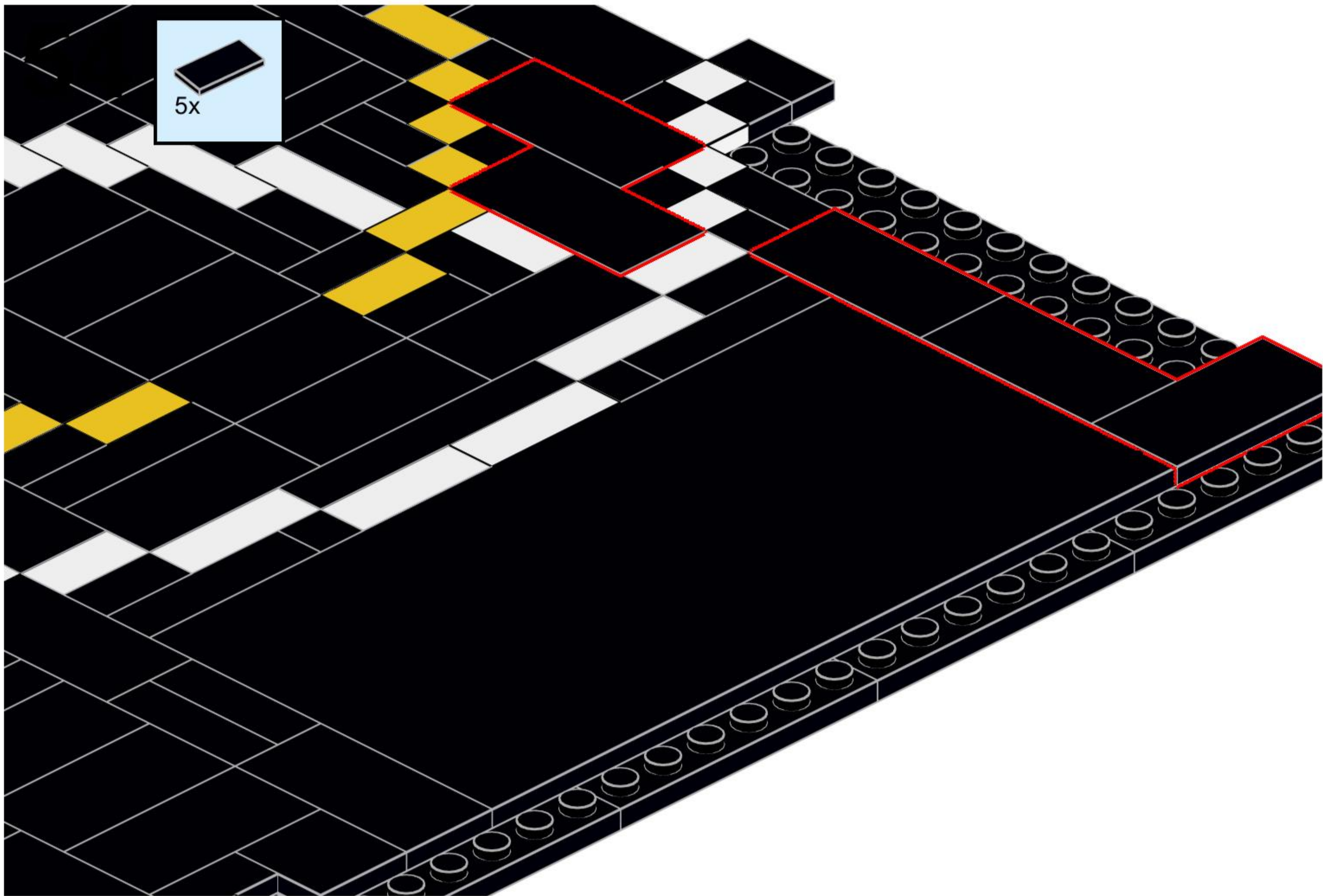

55

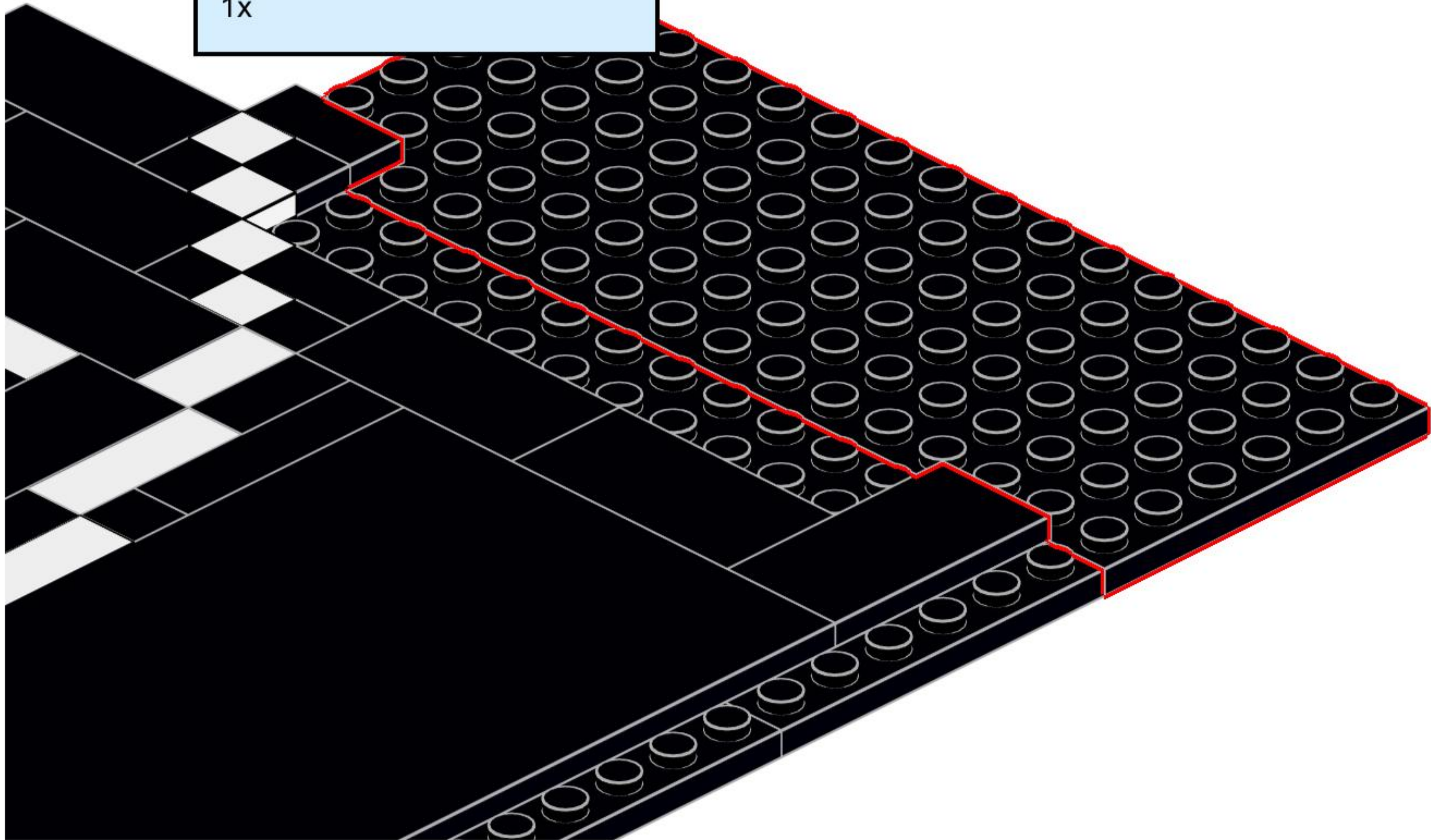
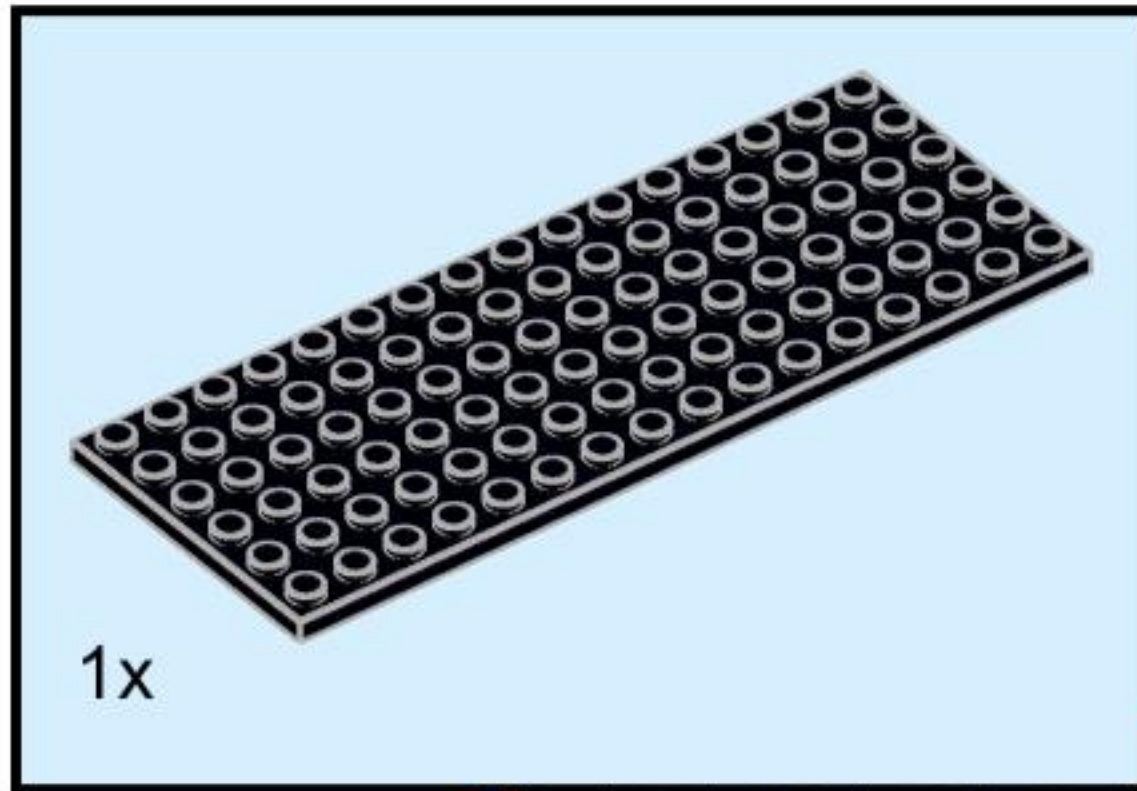

56

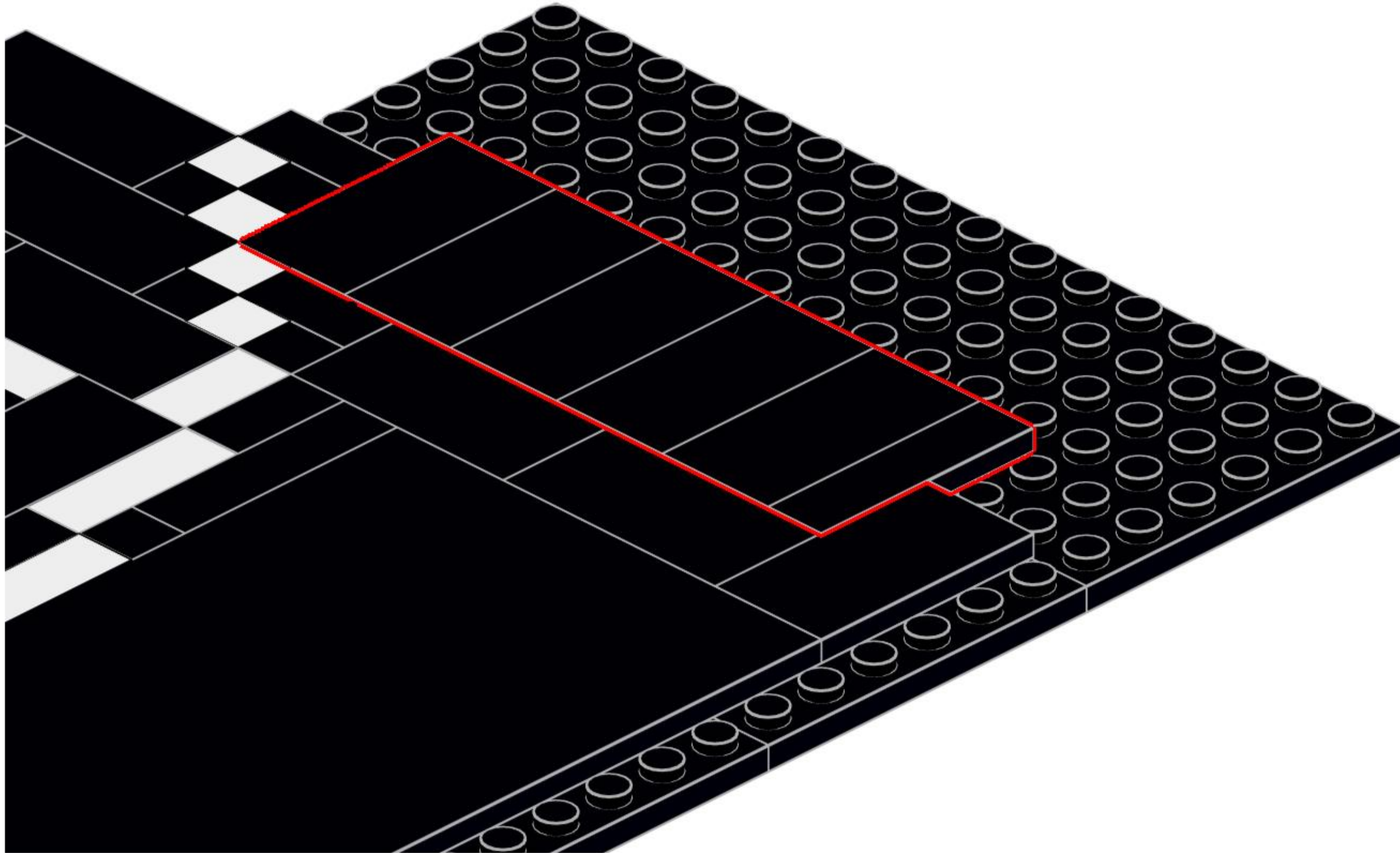
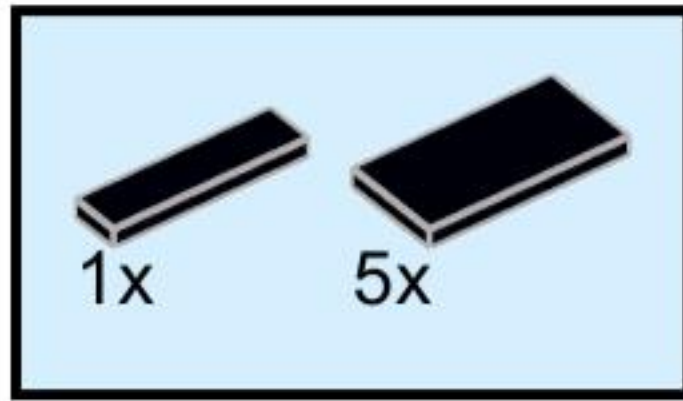

57

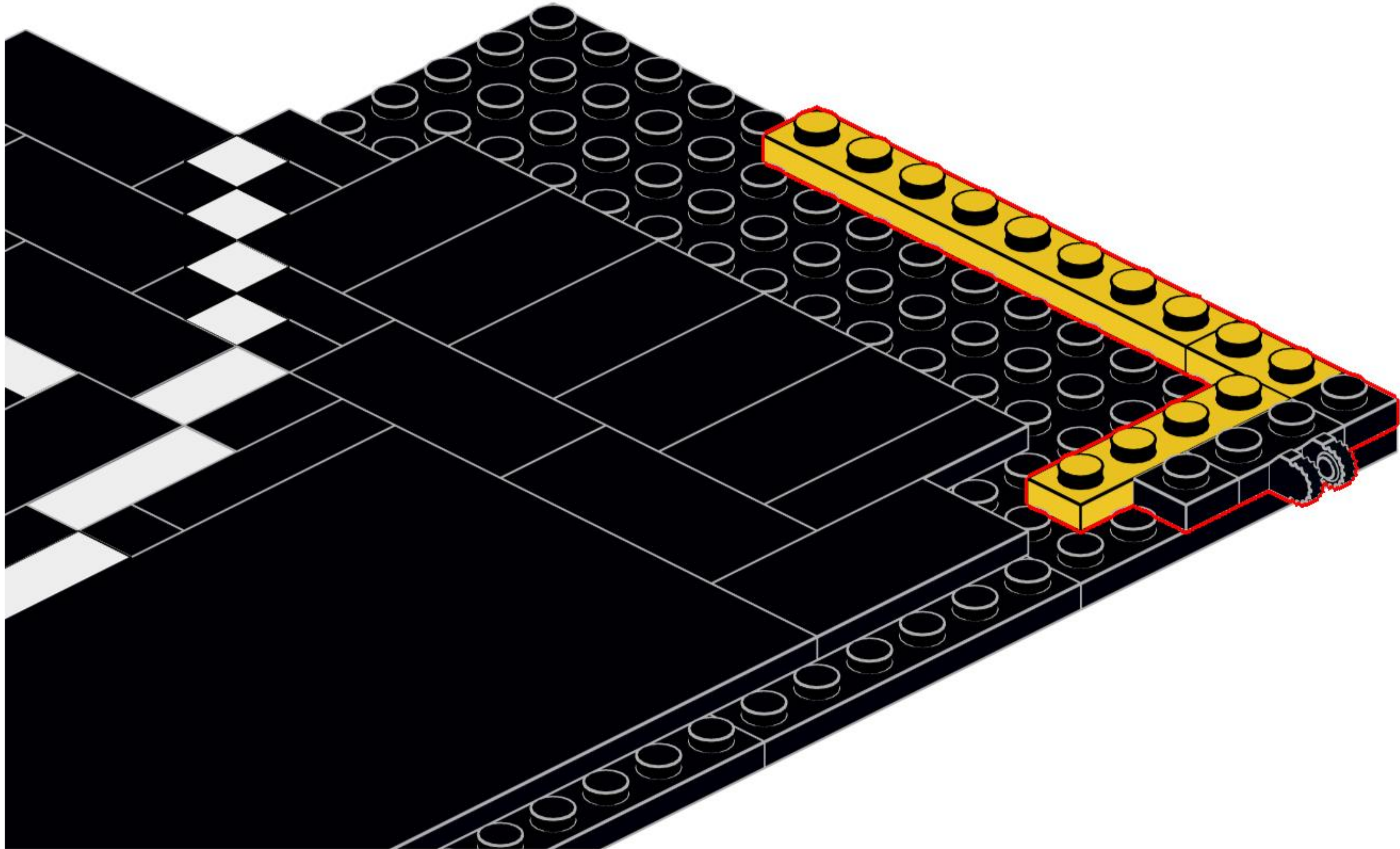
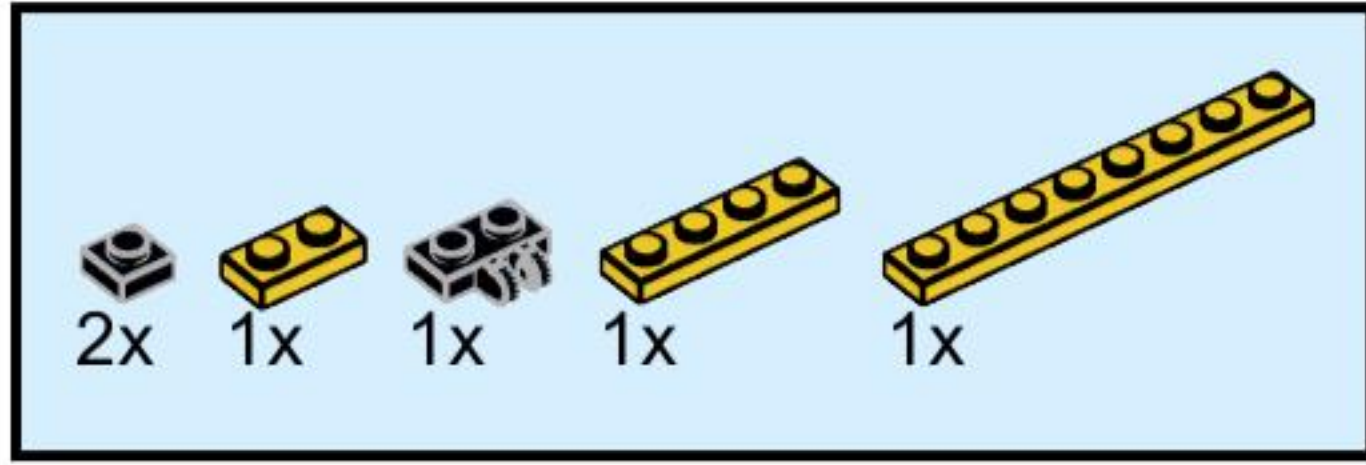

58

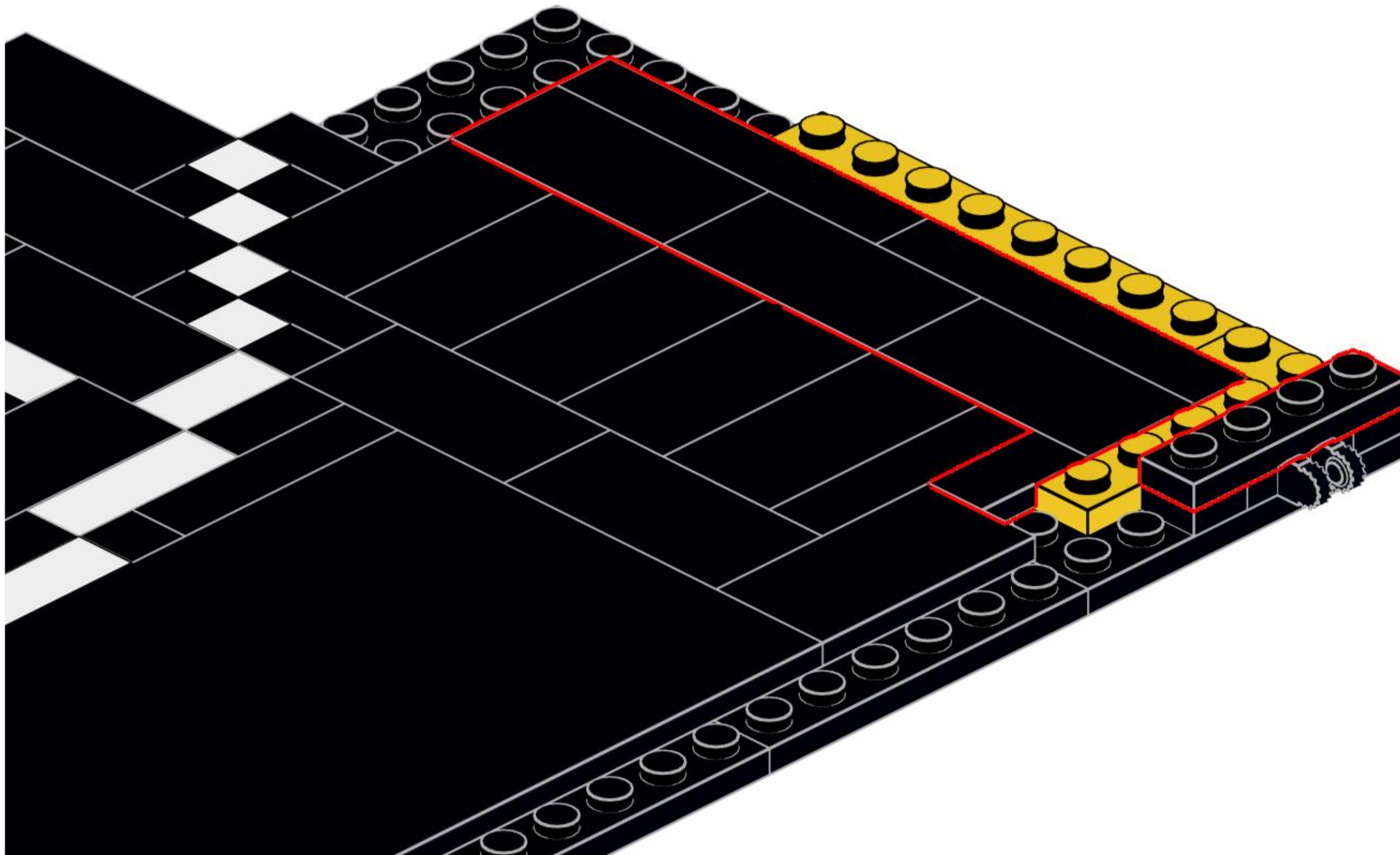
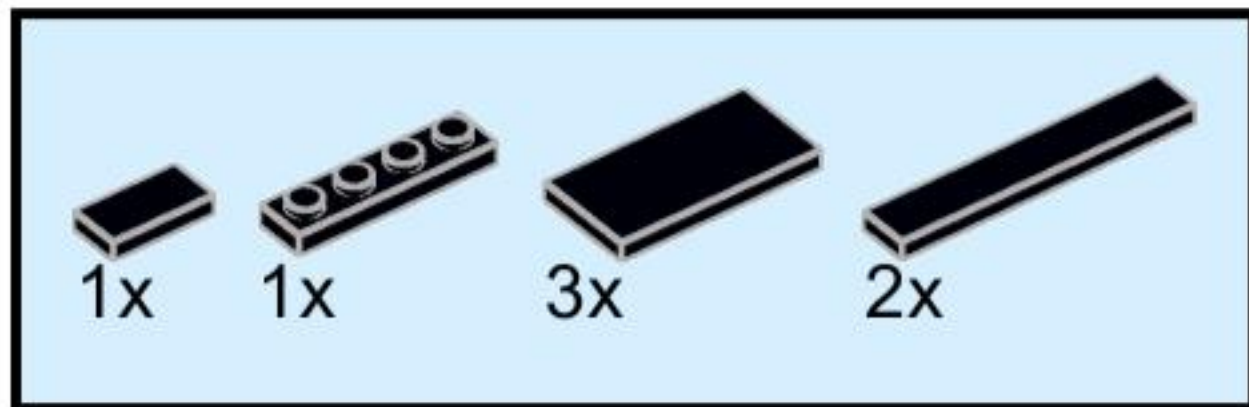

59

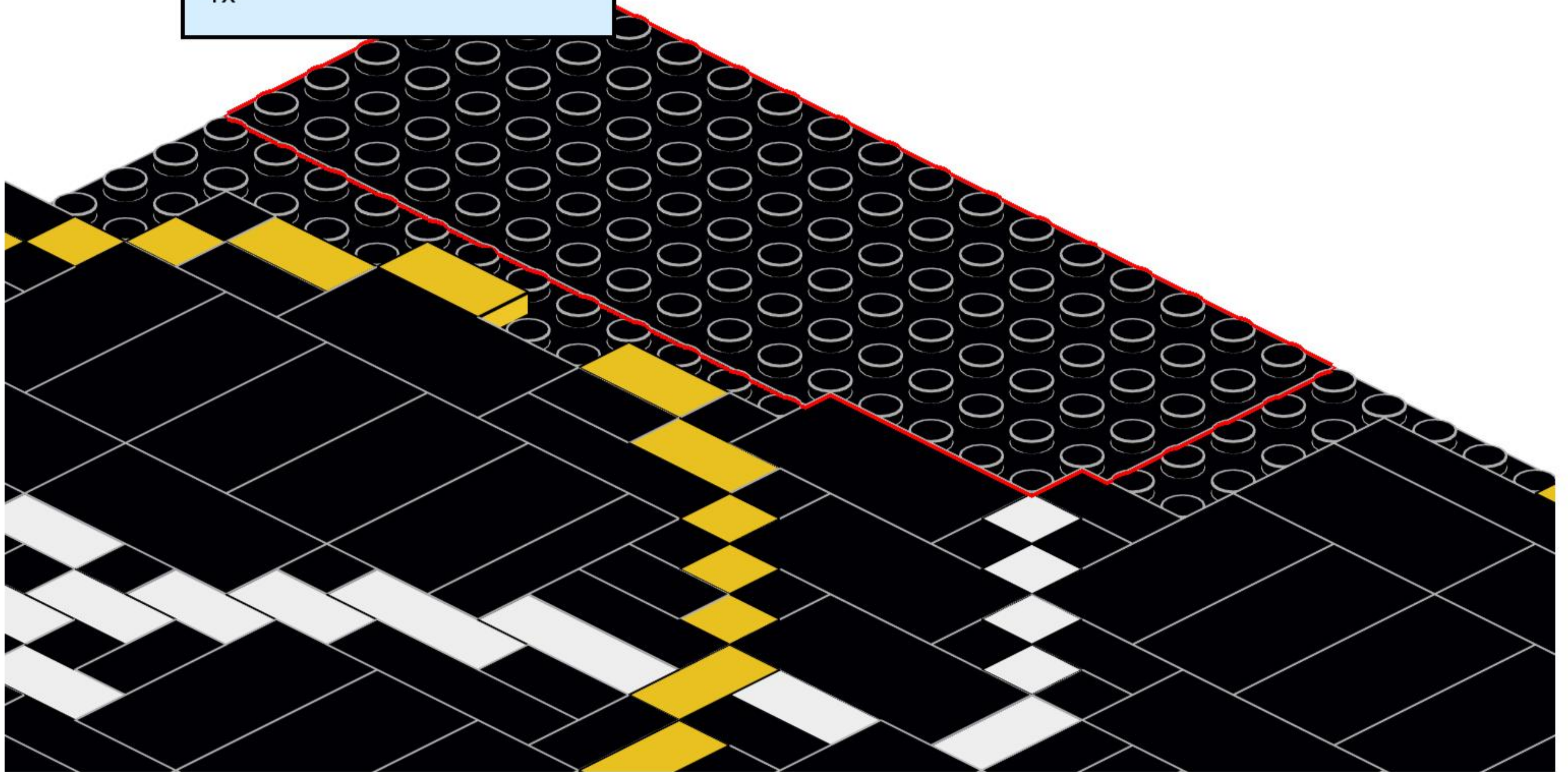
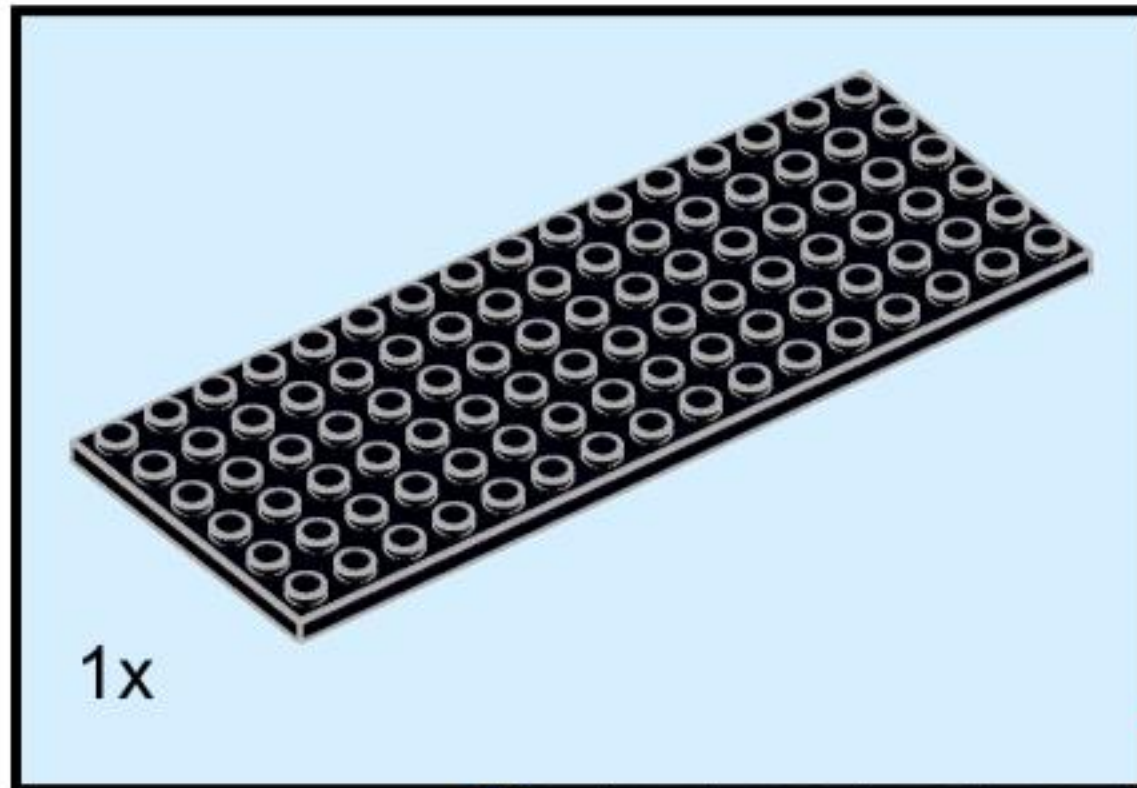

60

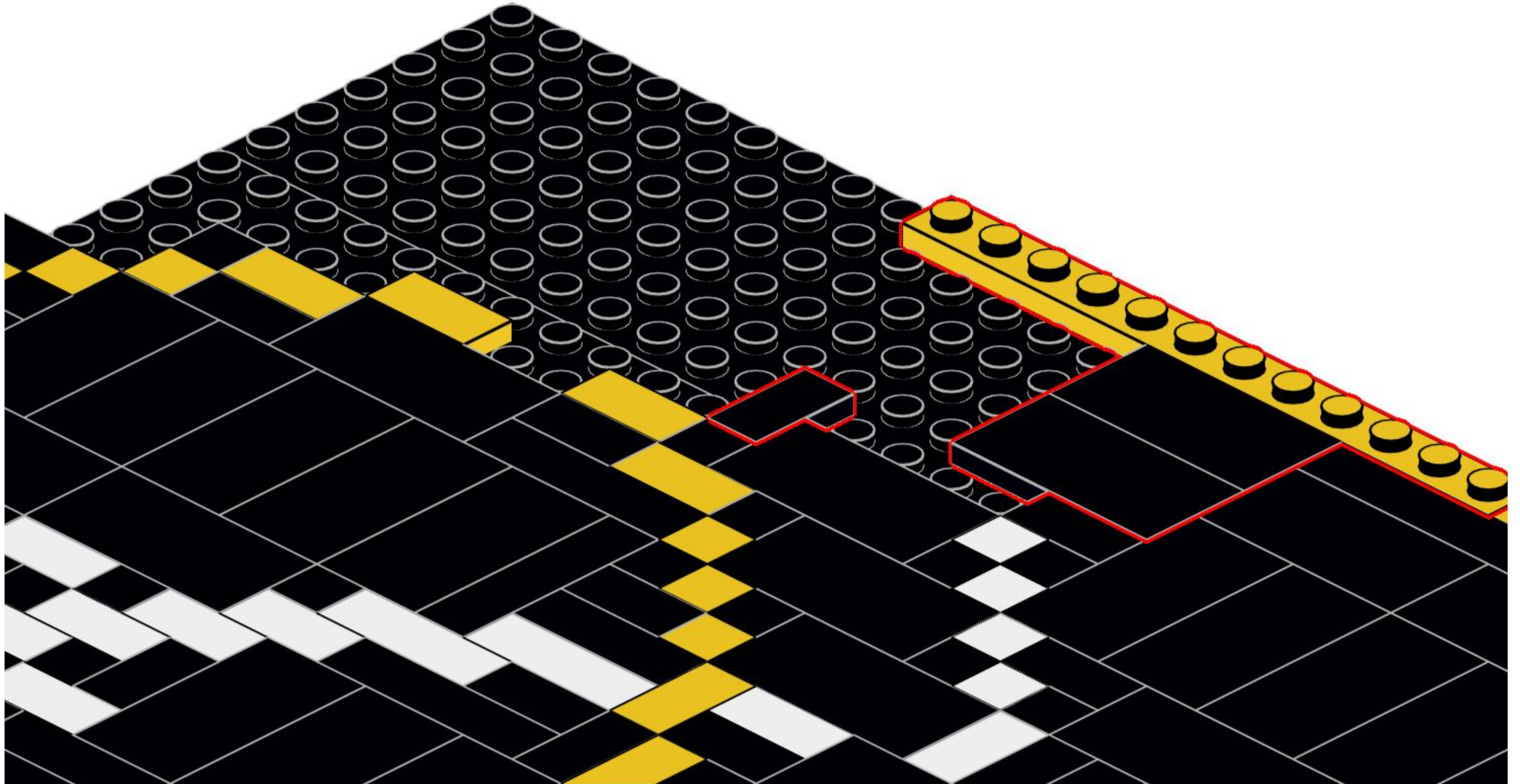
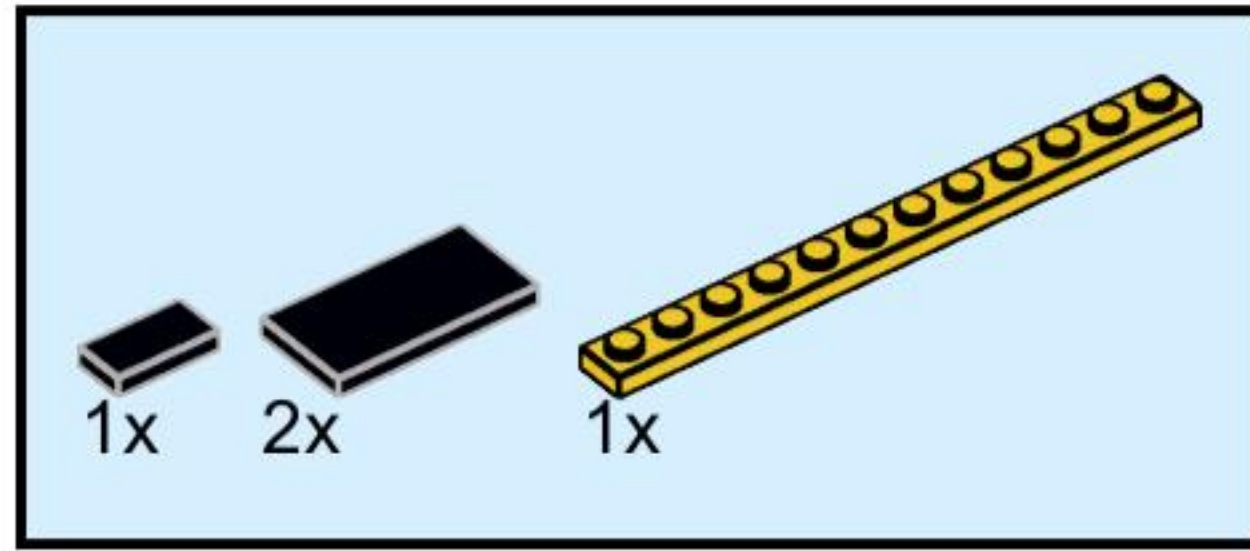

61

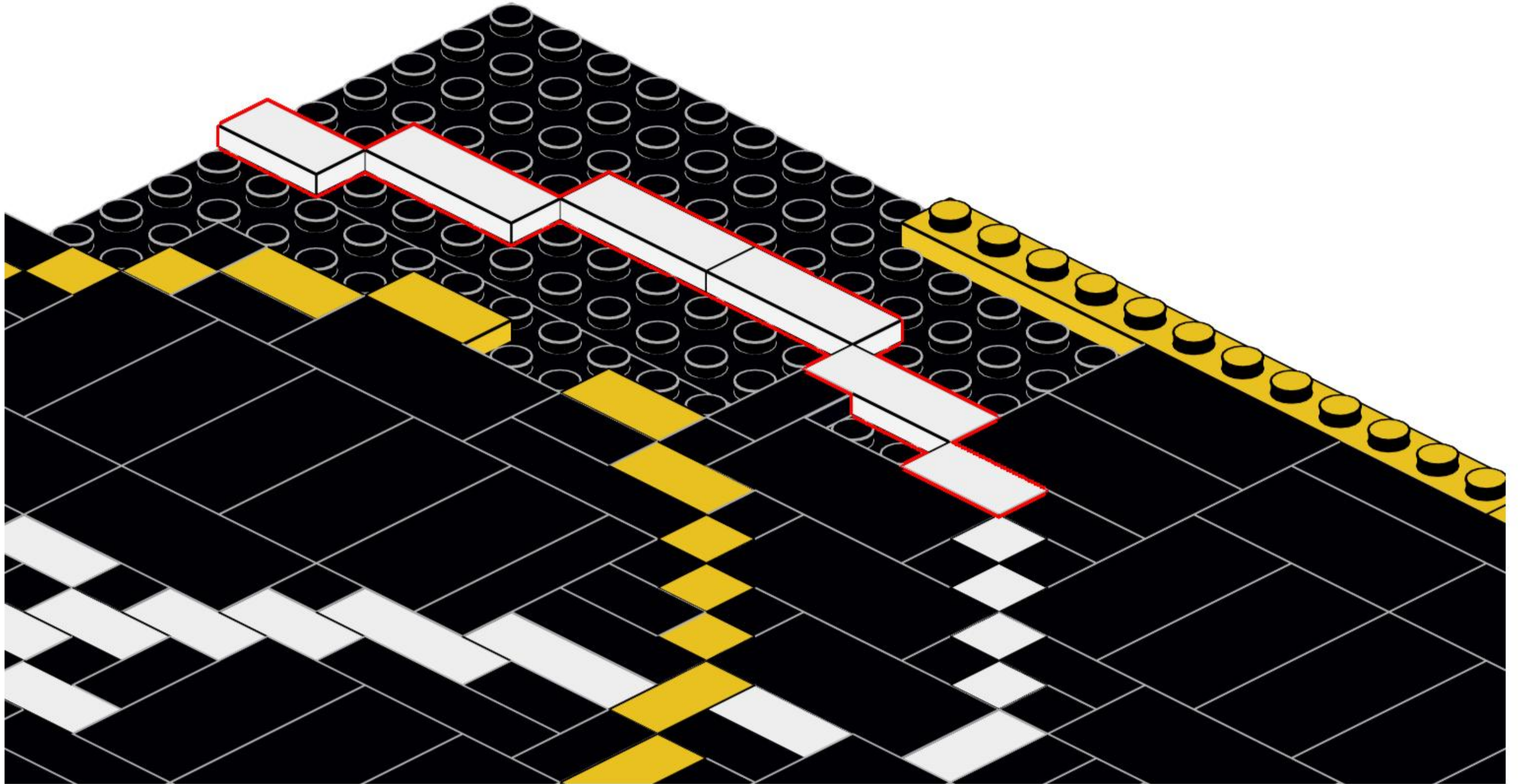
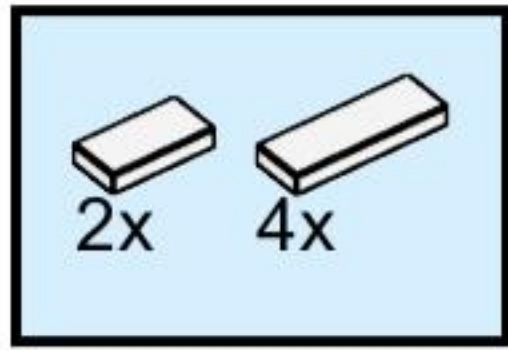

62

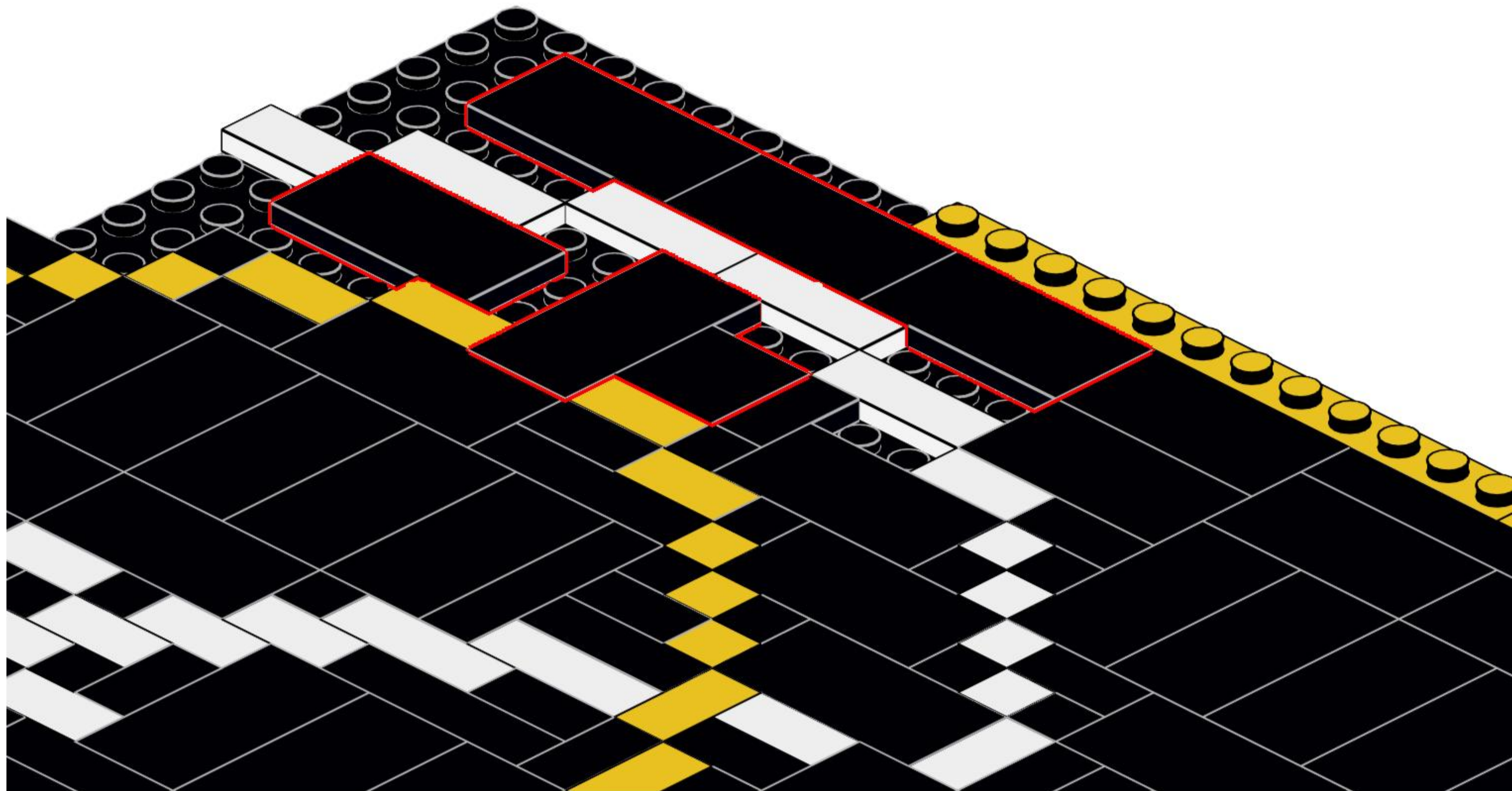
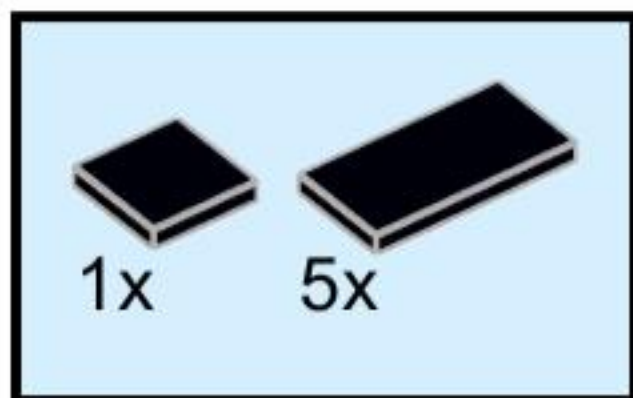

63

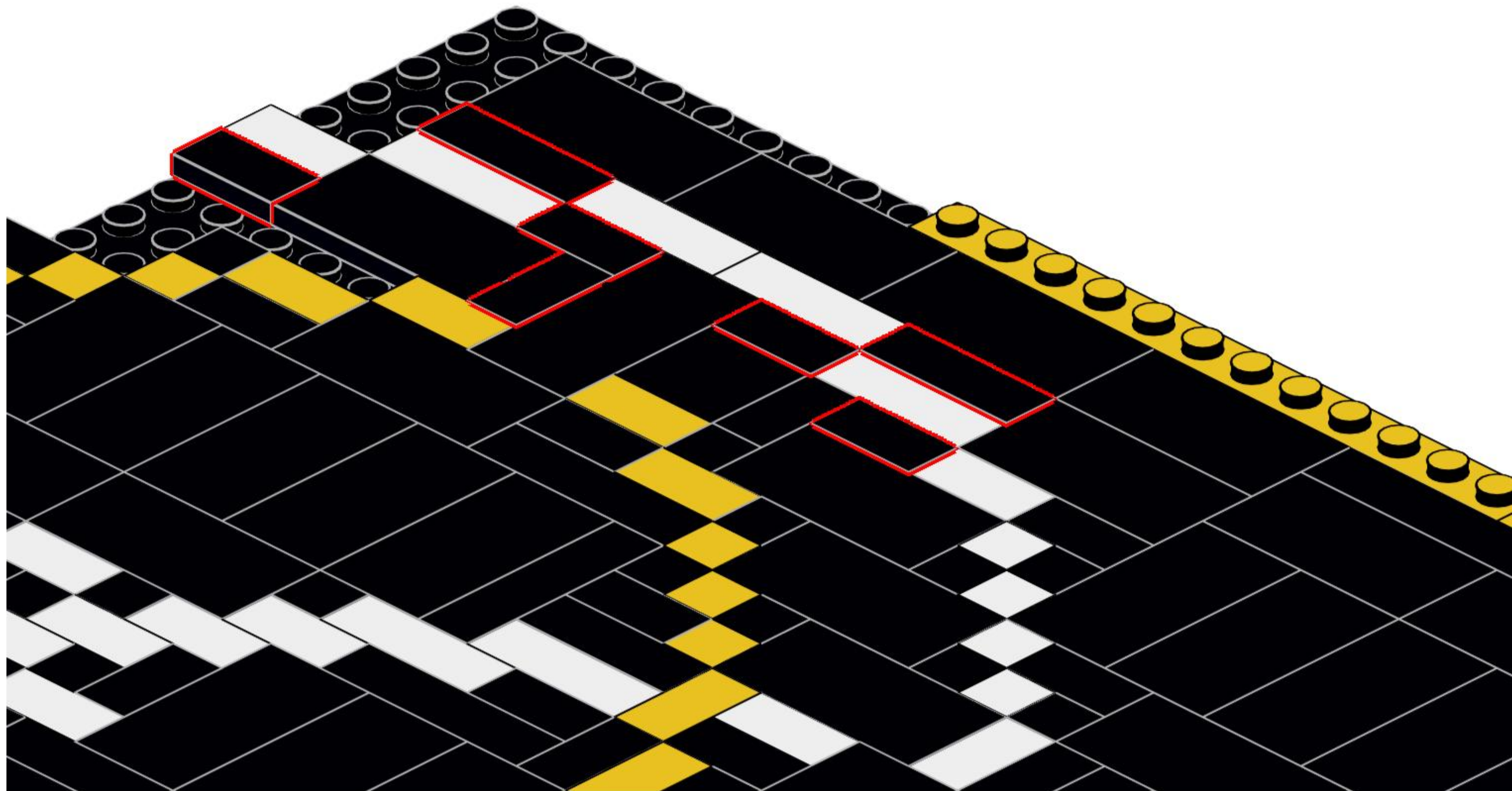
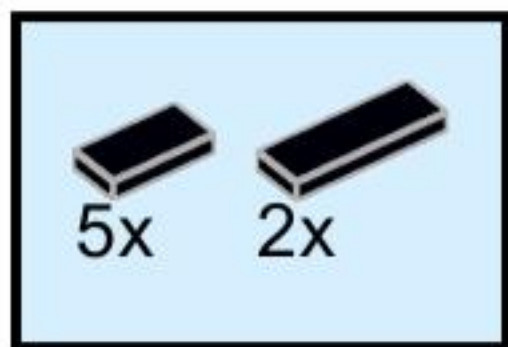

64

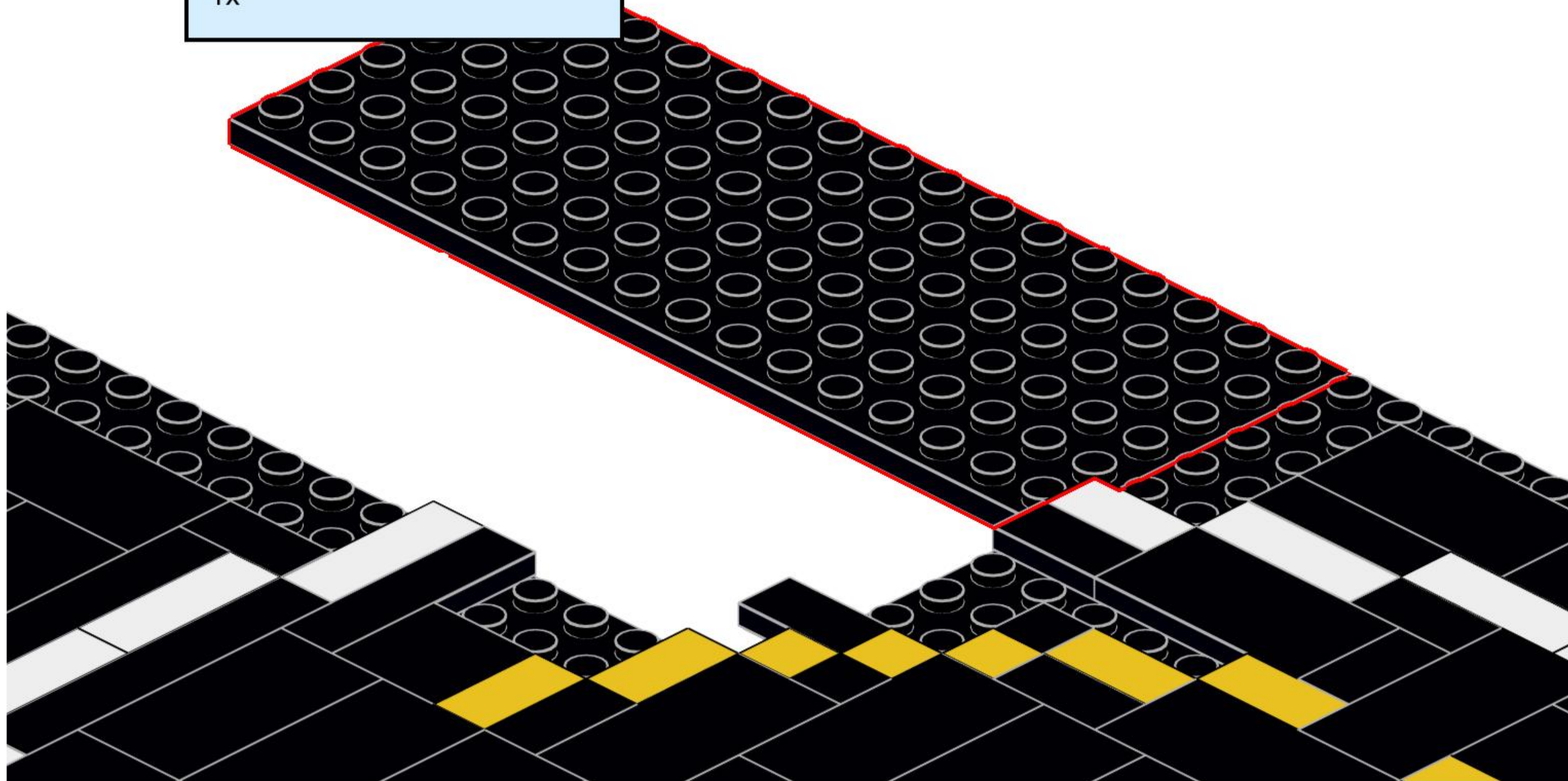
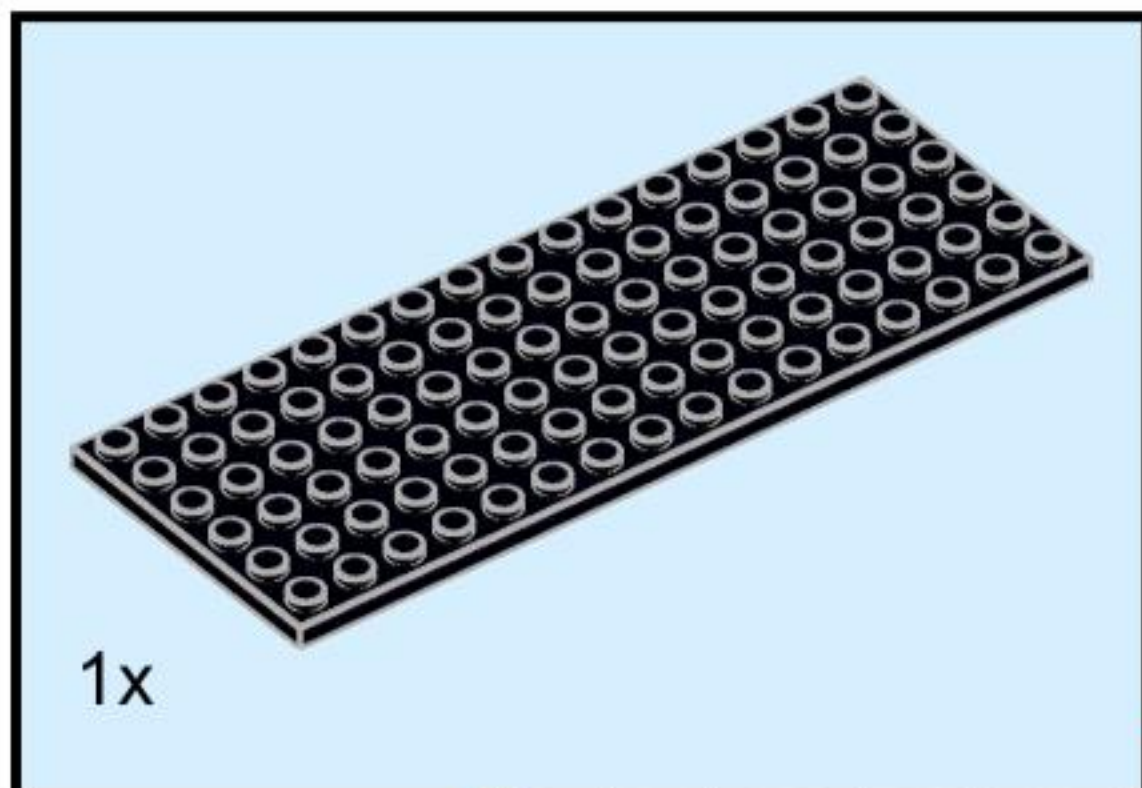

65

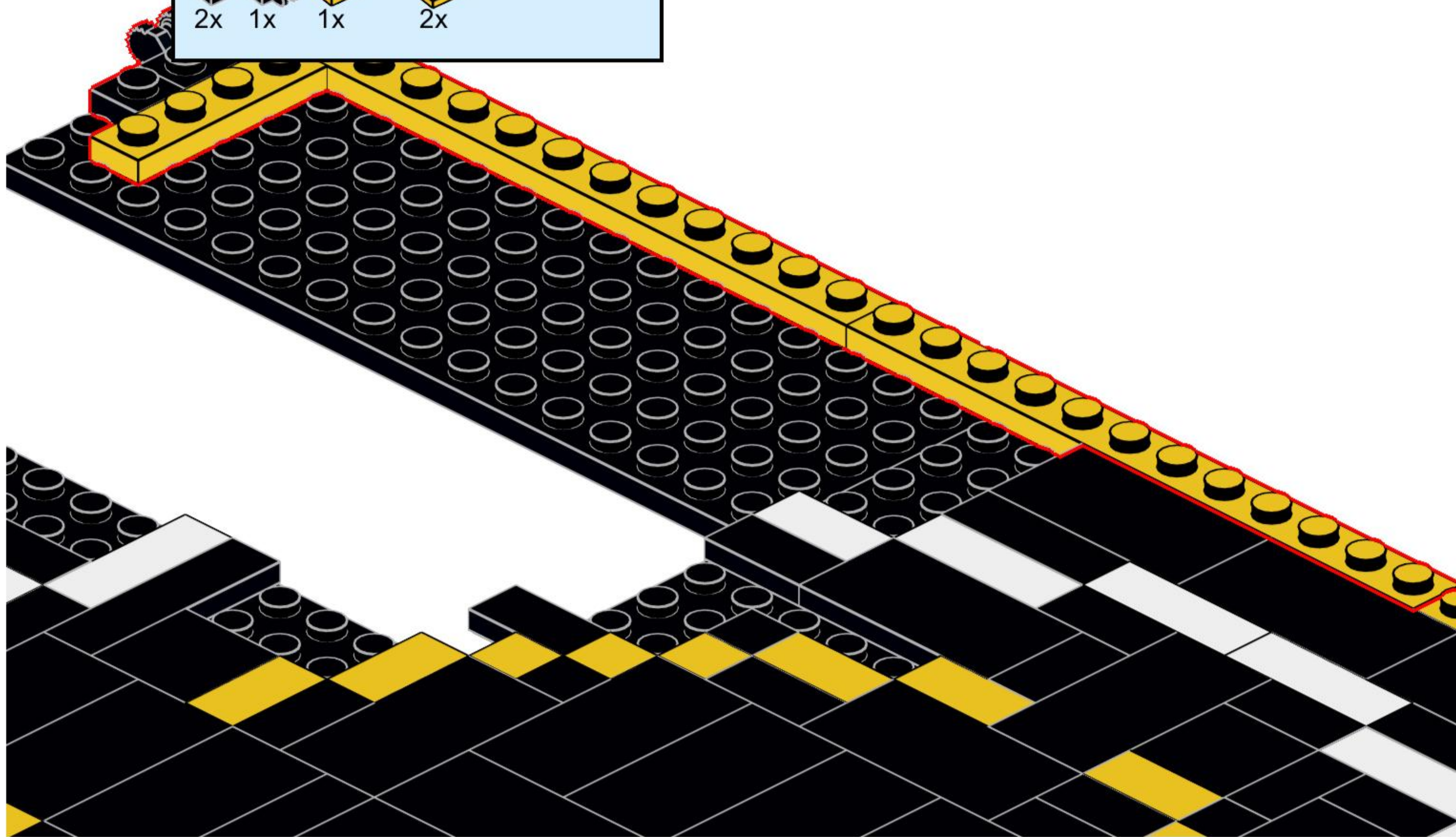
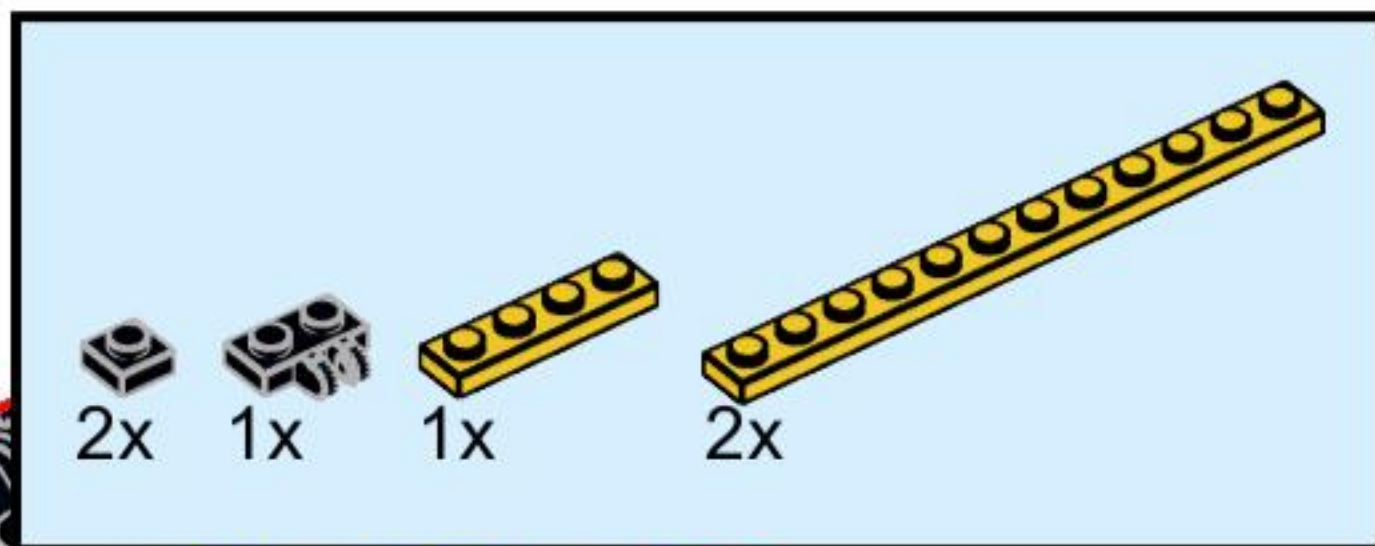

66

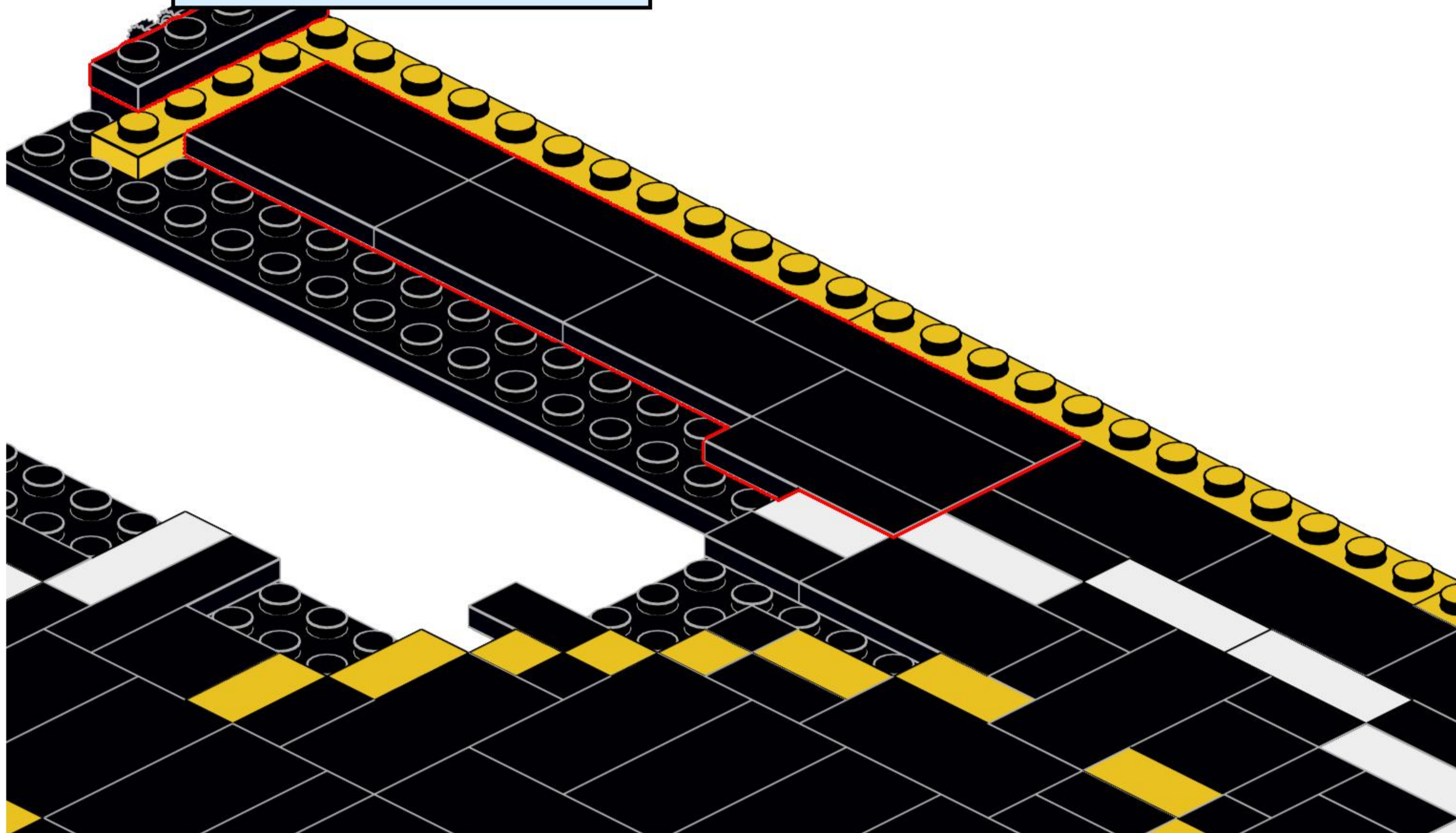
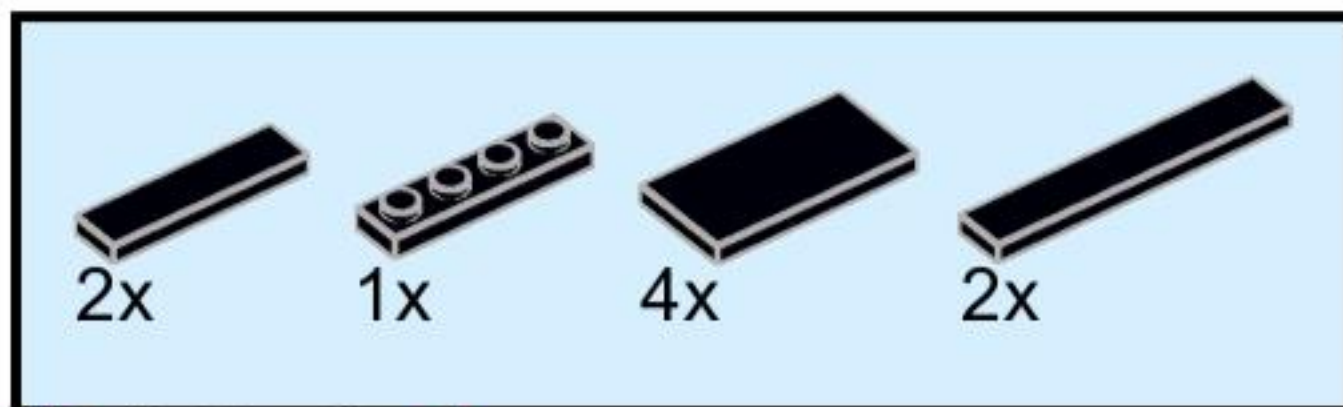

67

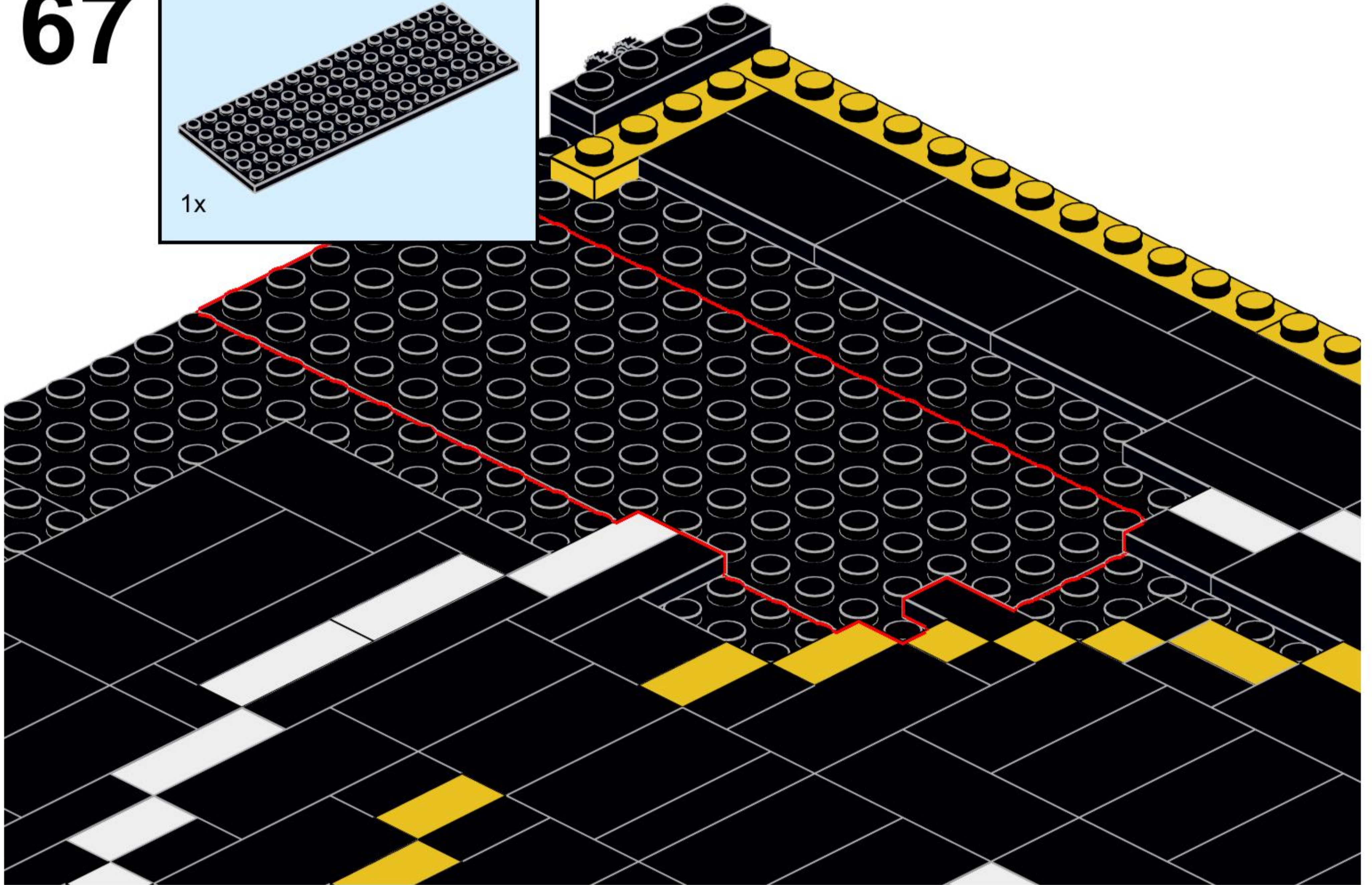
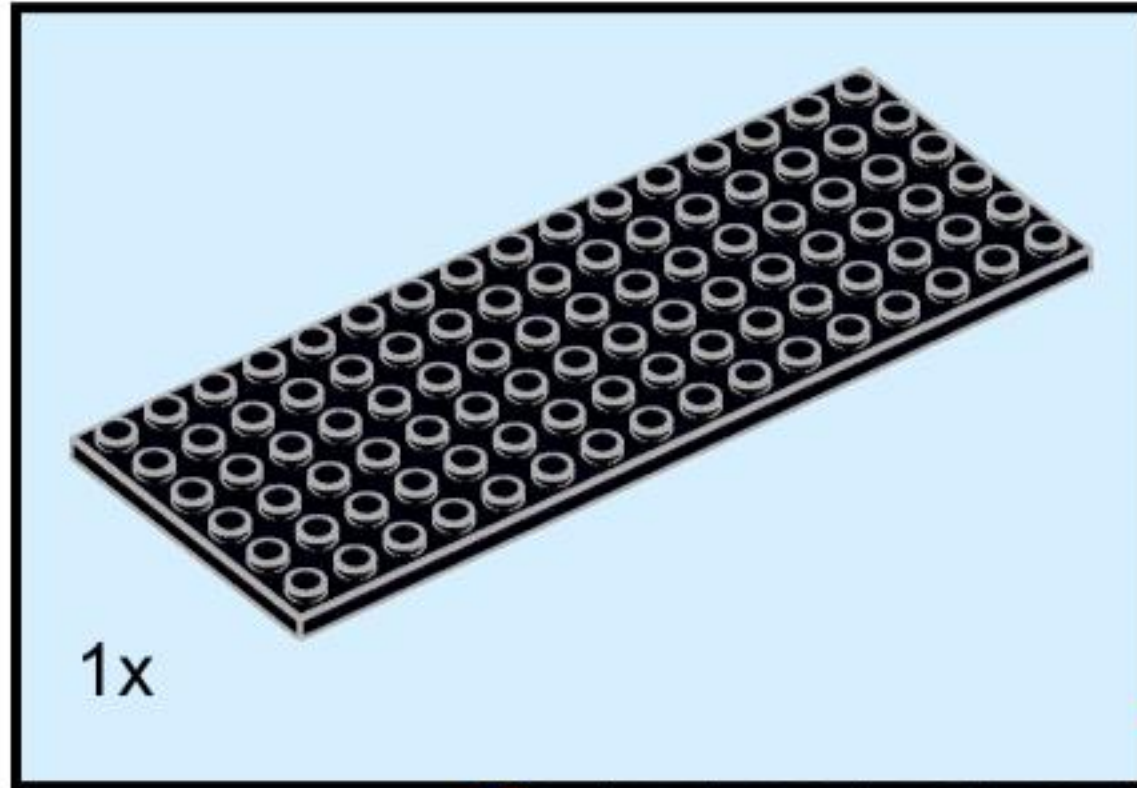

68

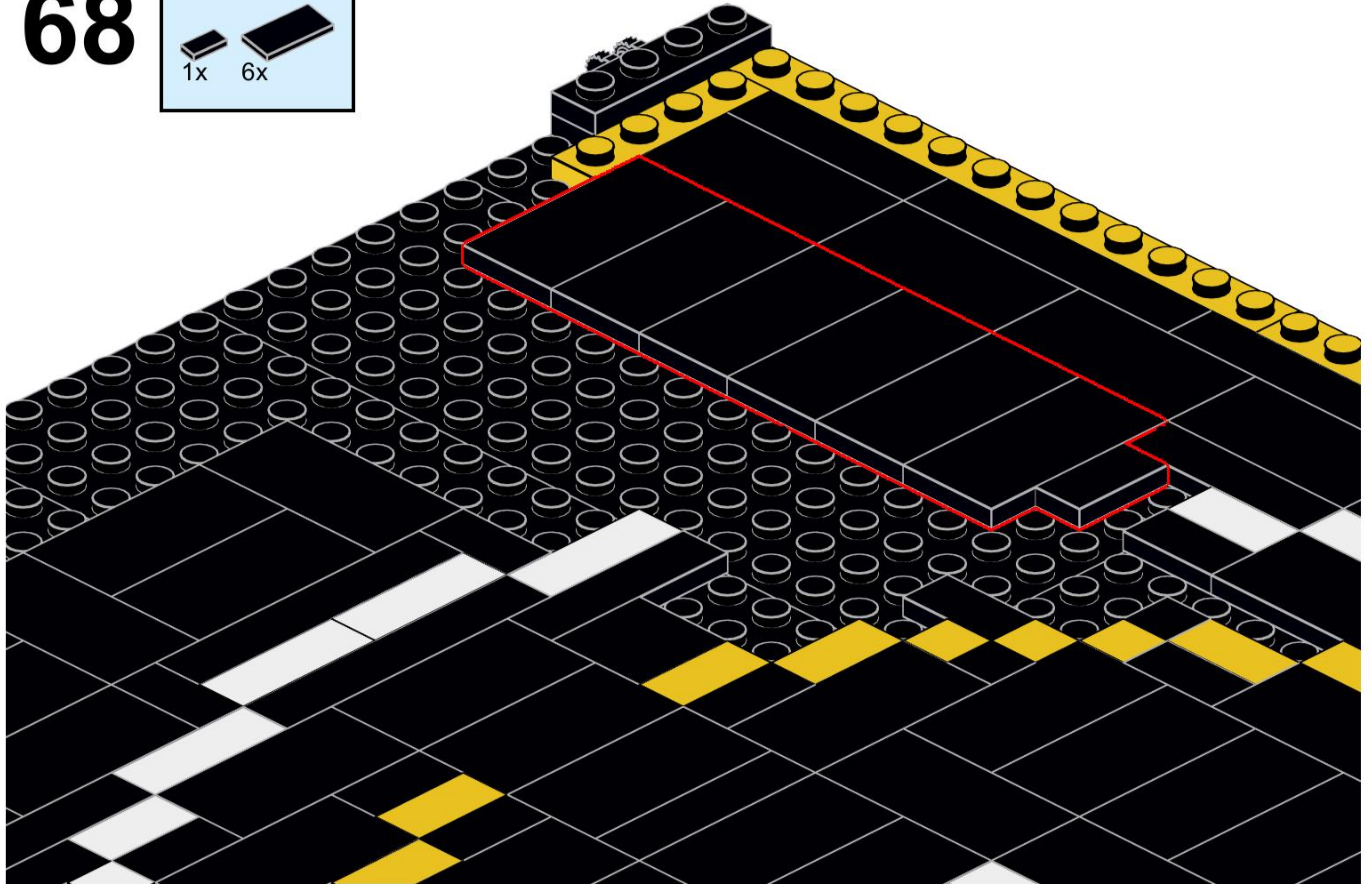
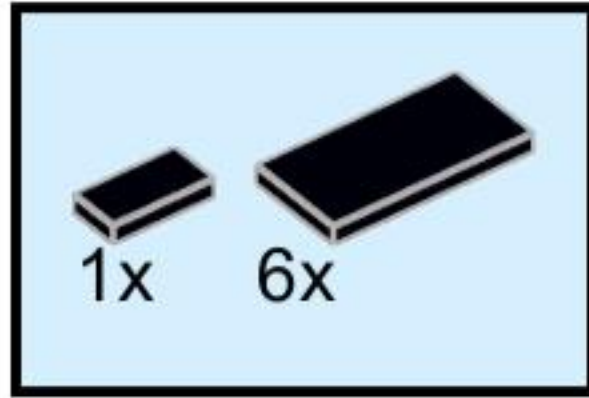

69

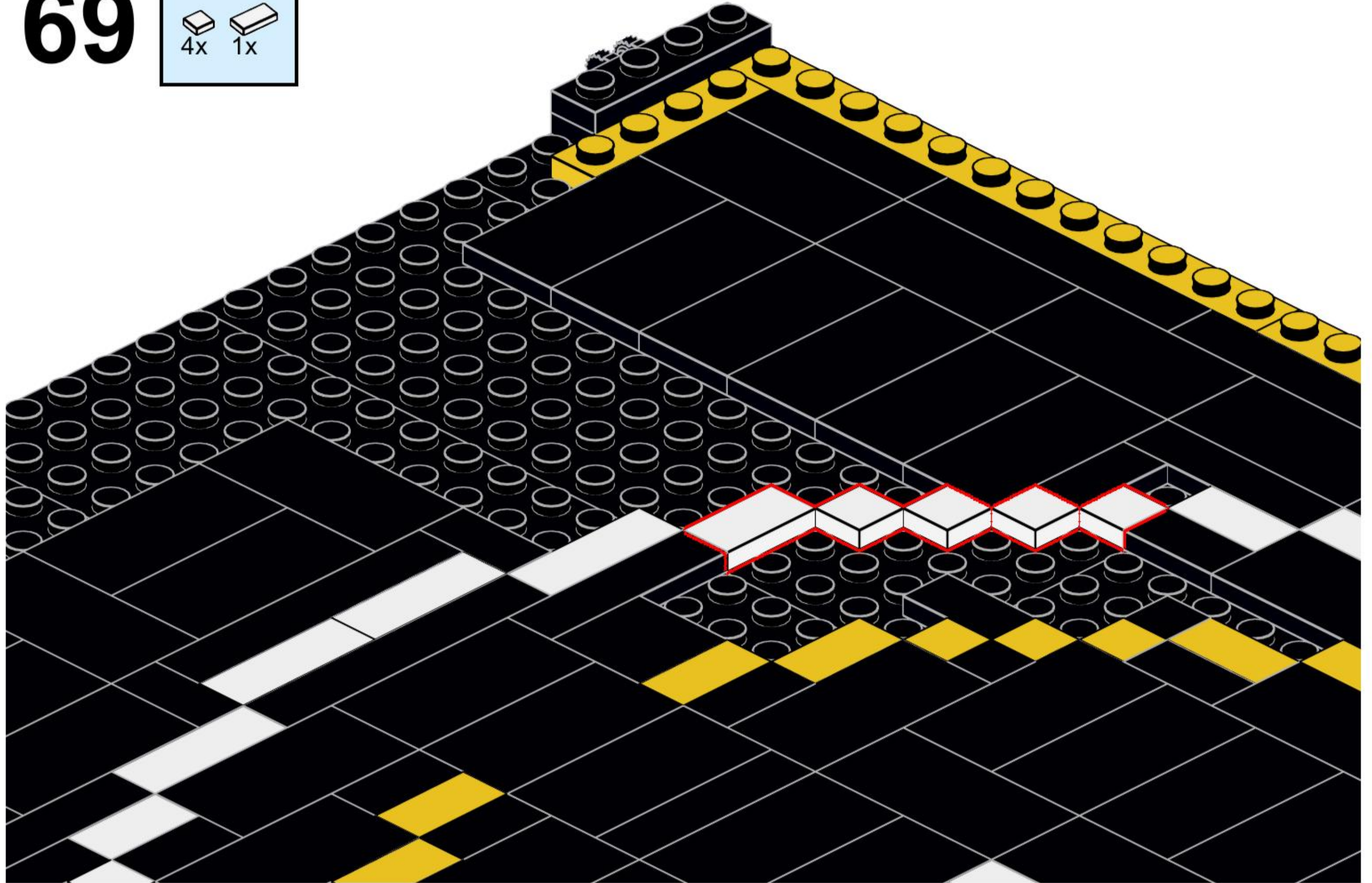
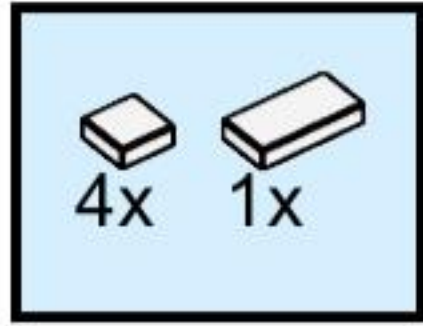

70

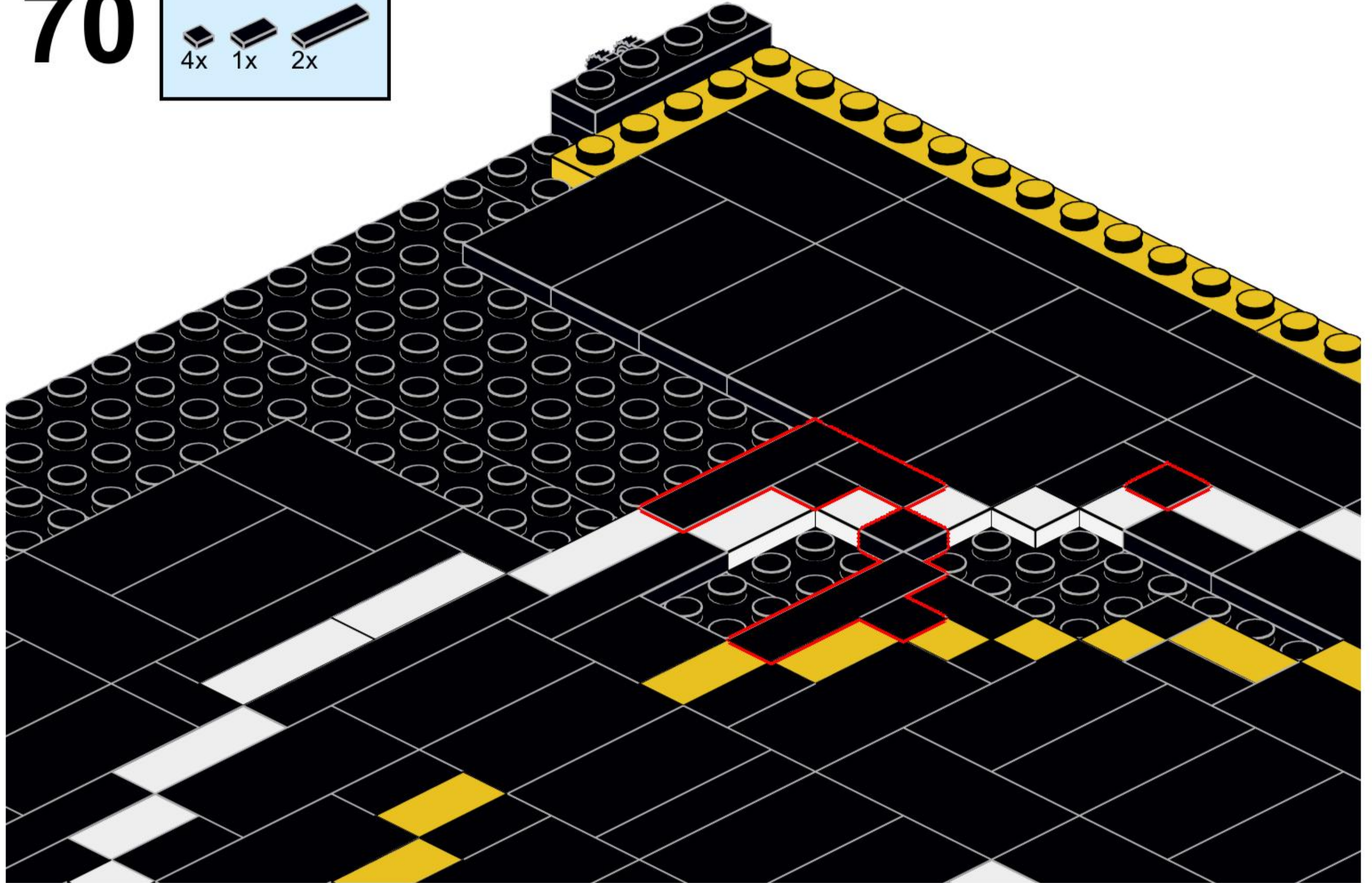
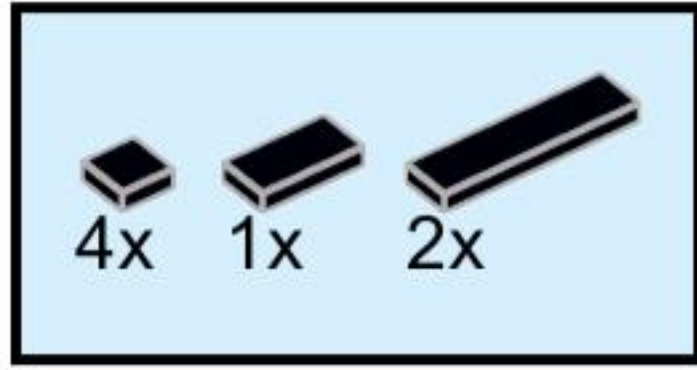

71

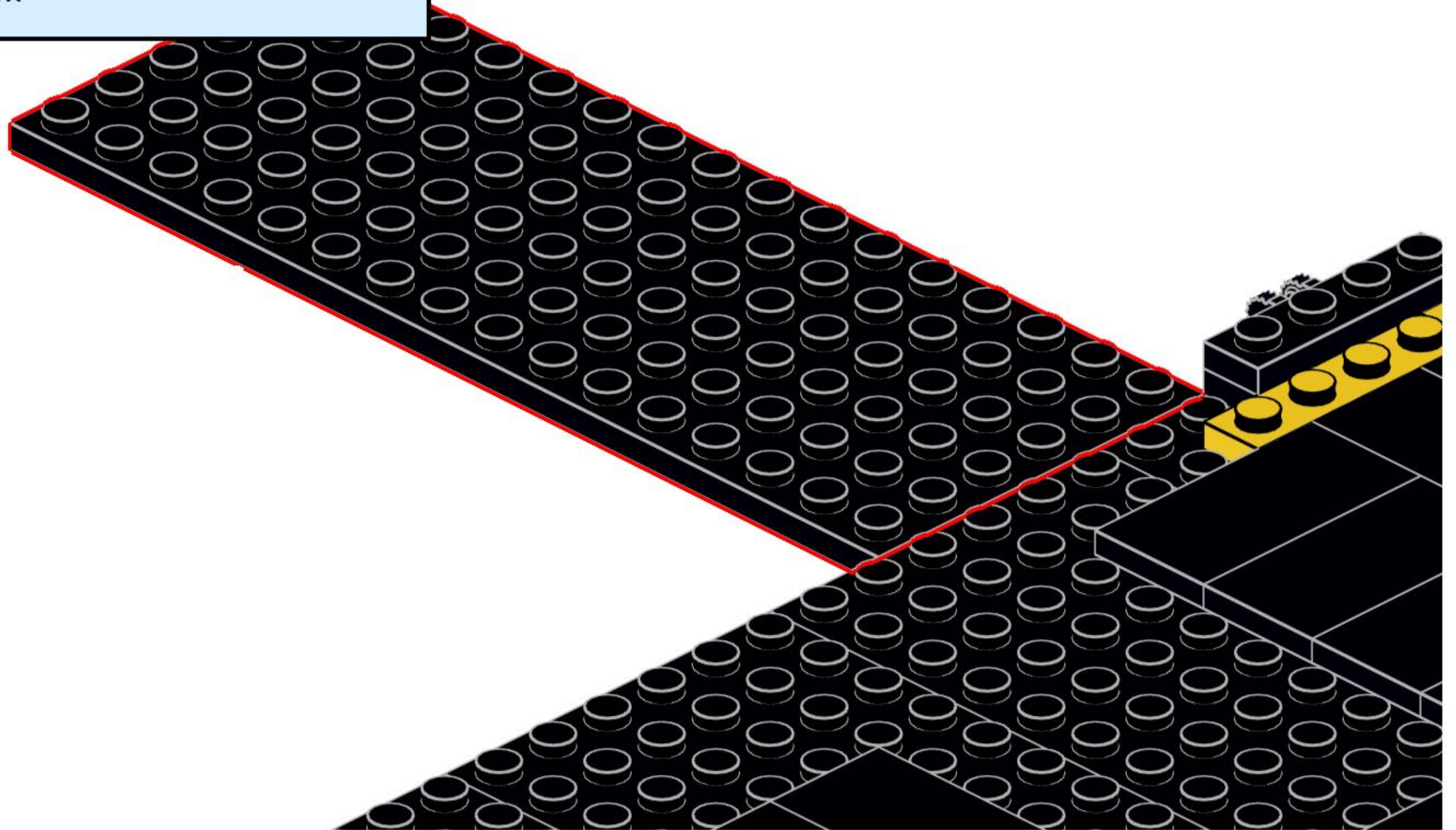
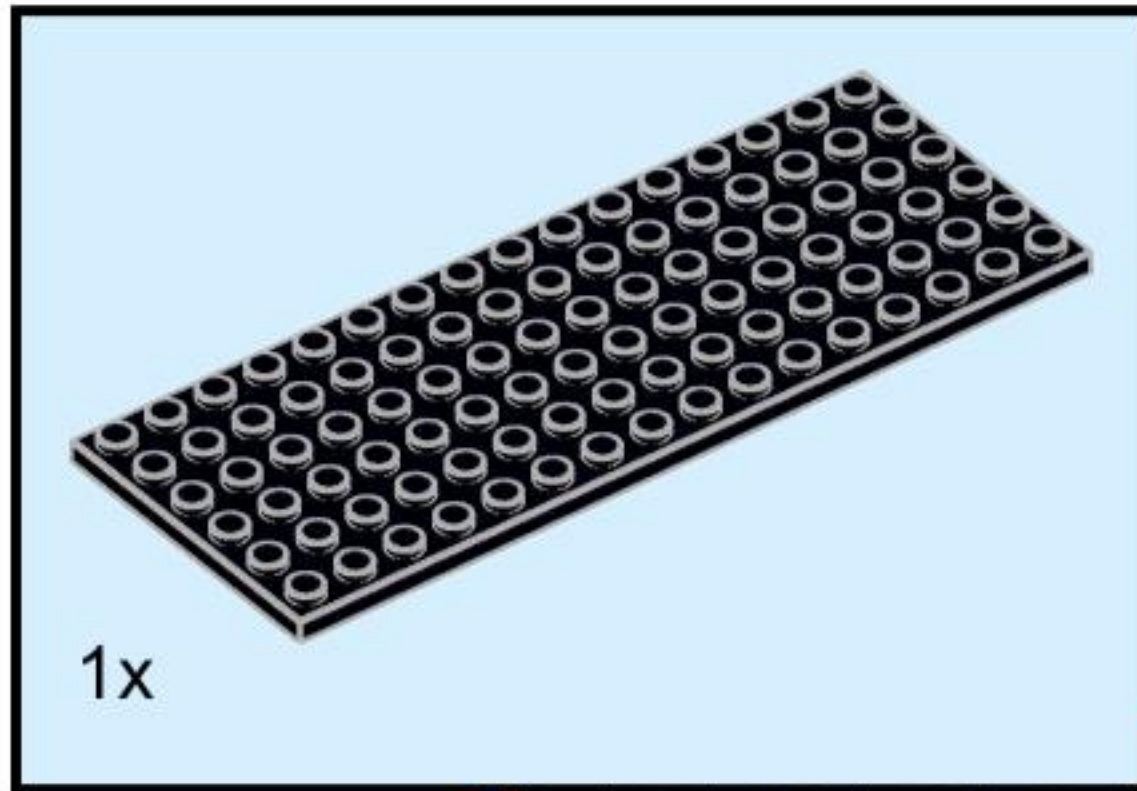

72

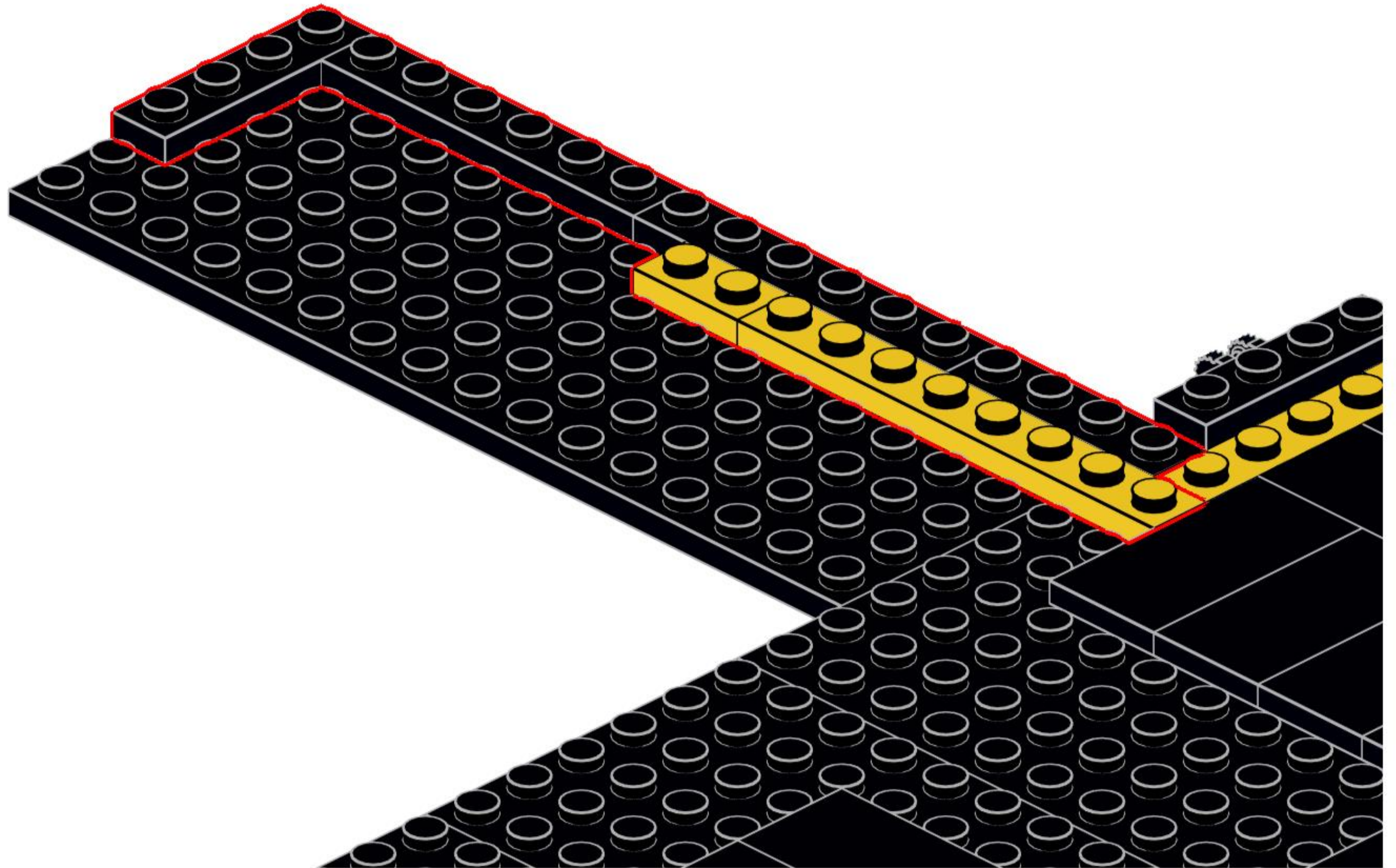
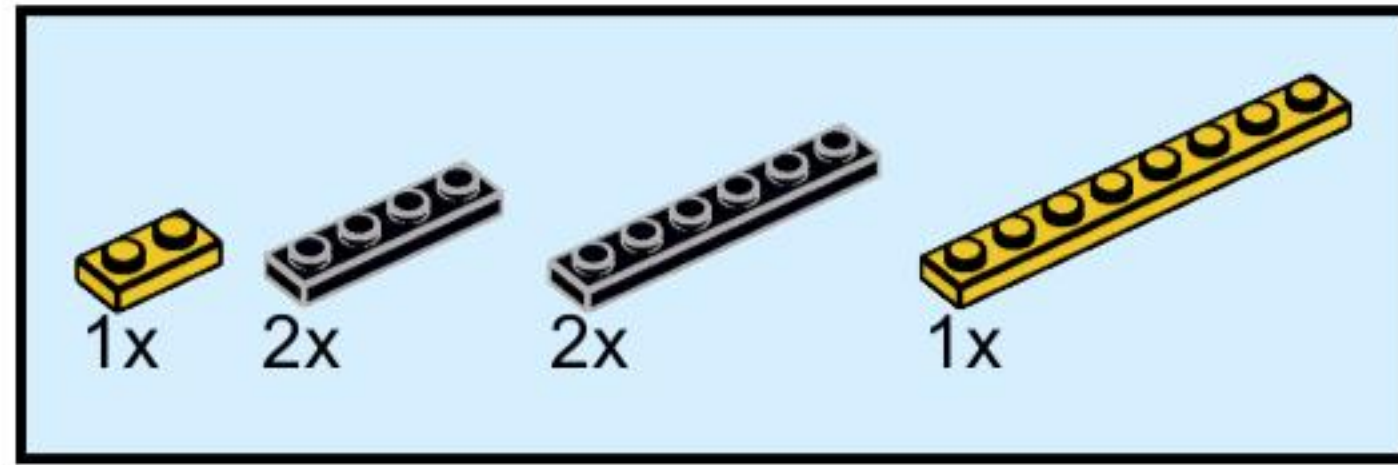

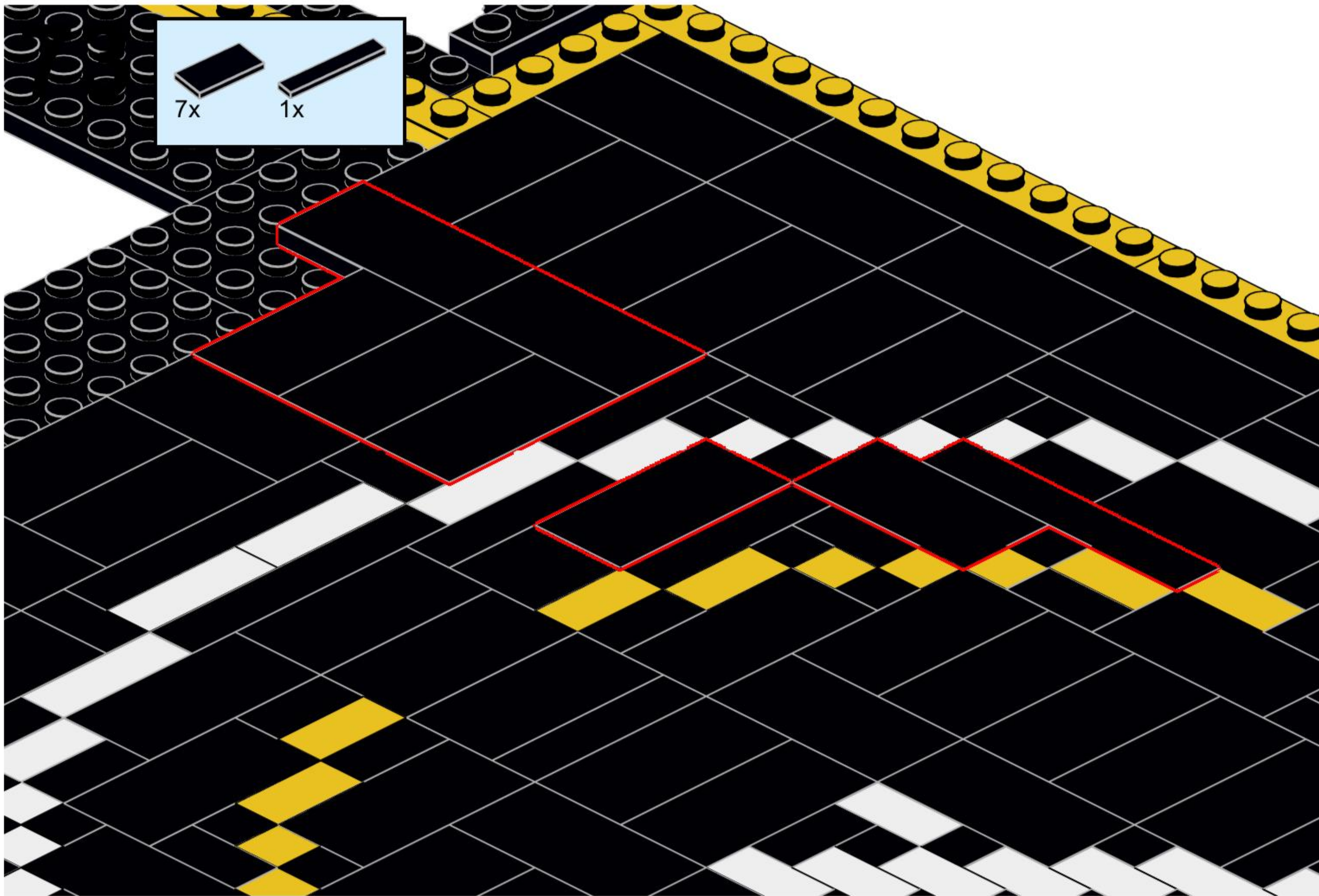

7x 1x

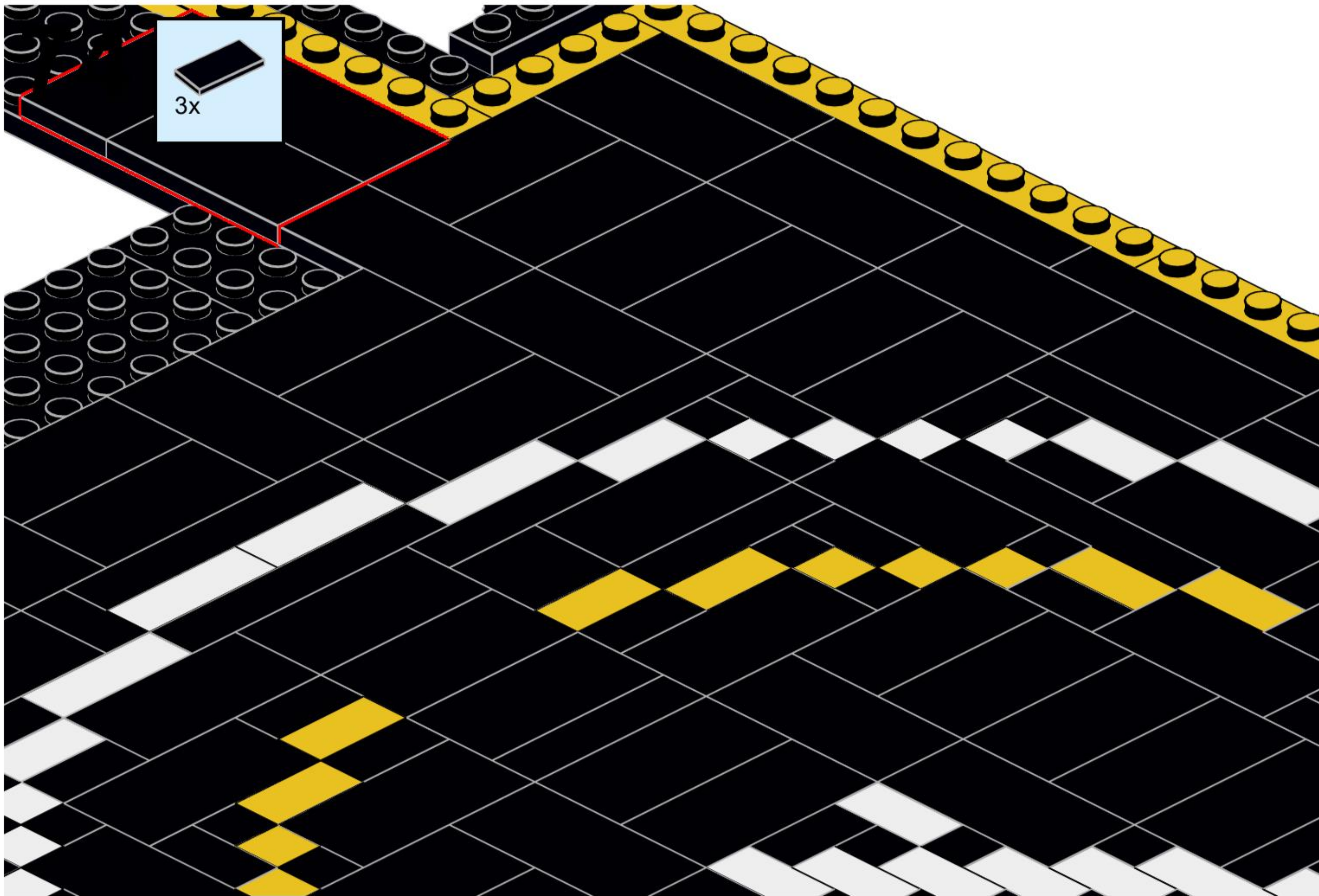

3x

75

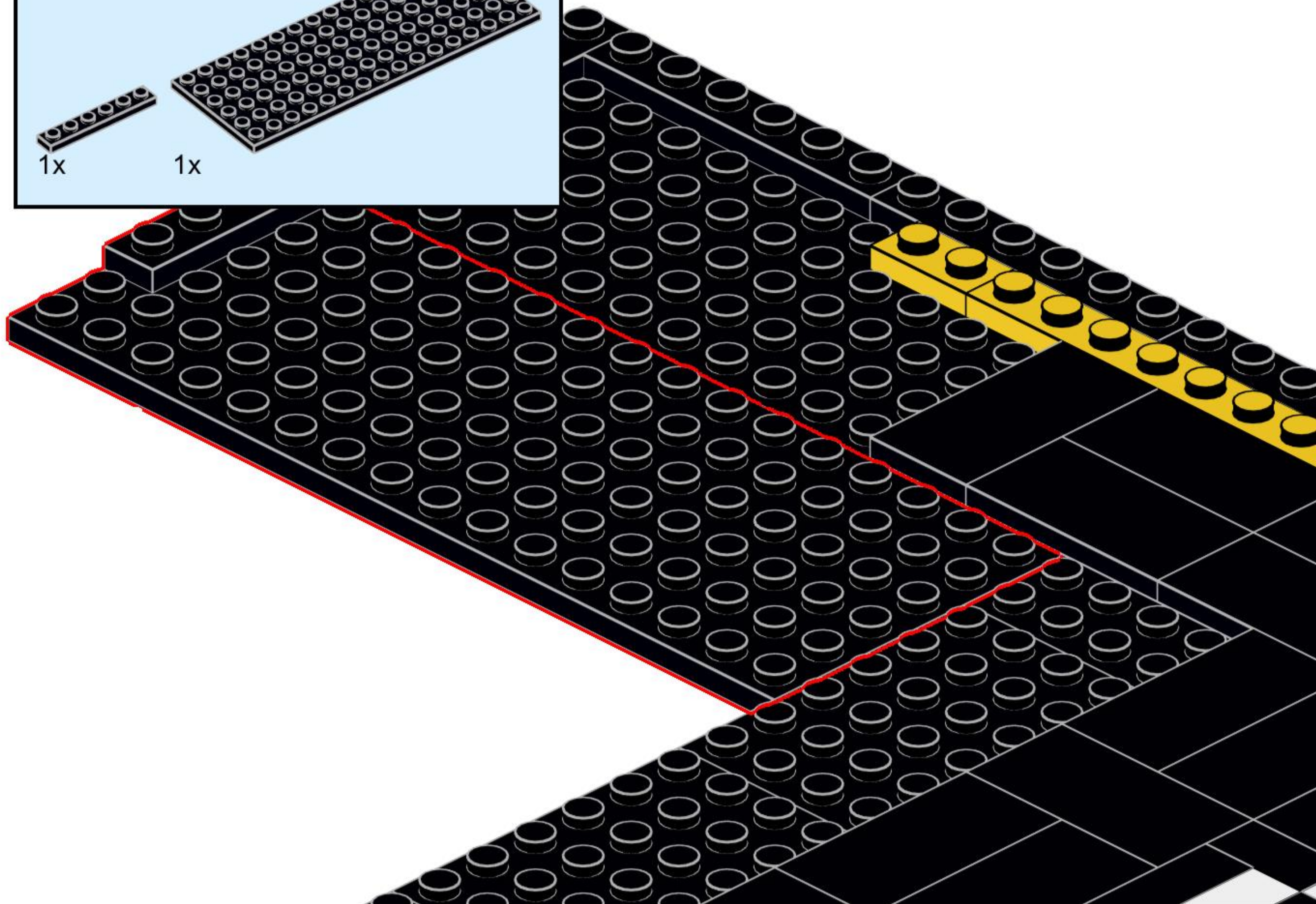
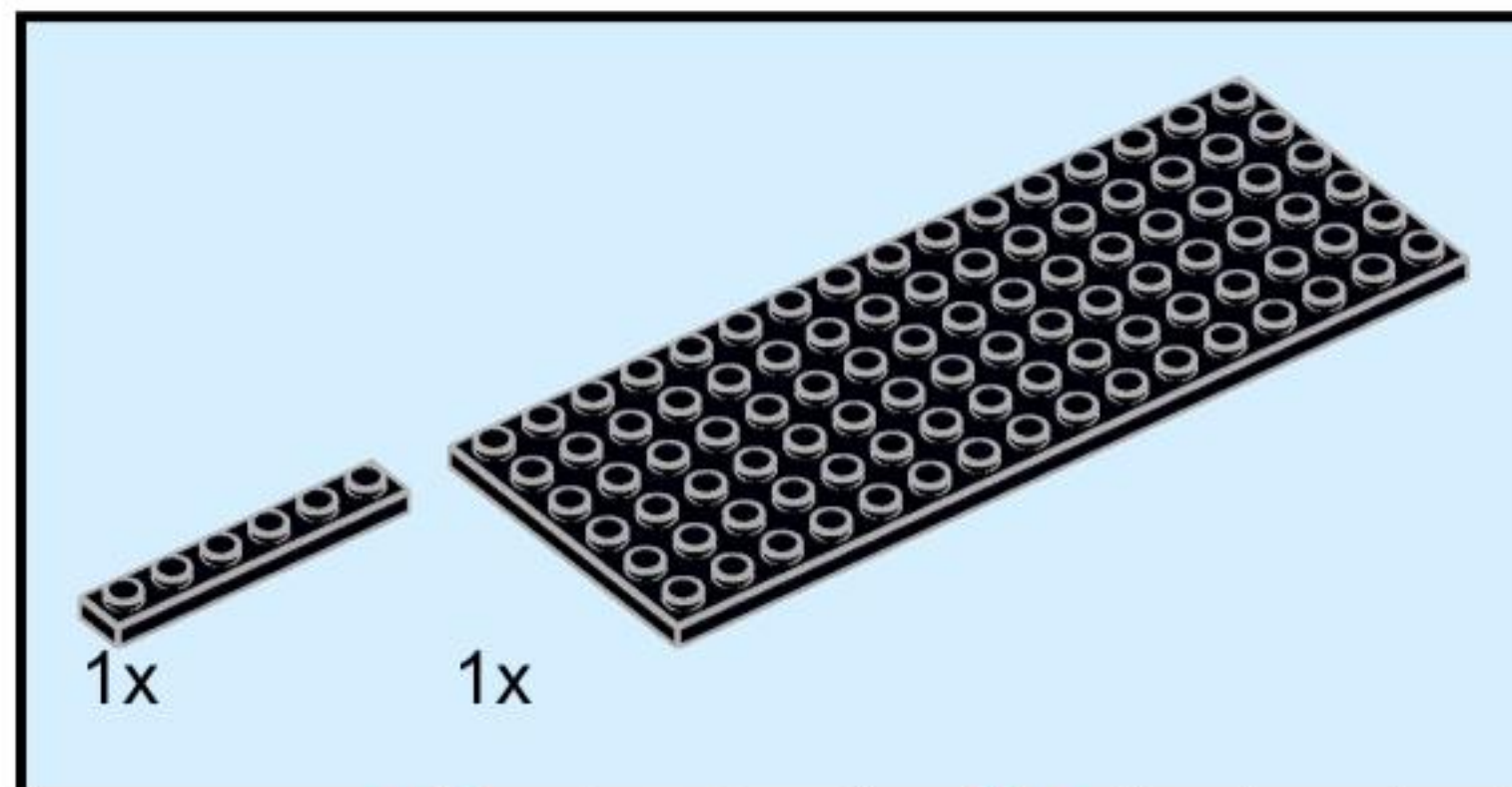

76

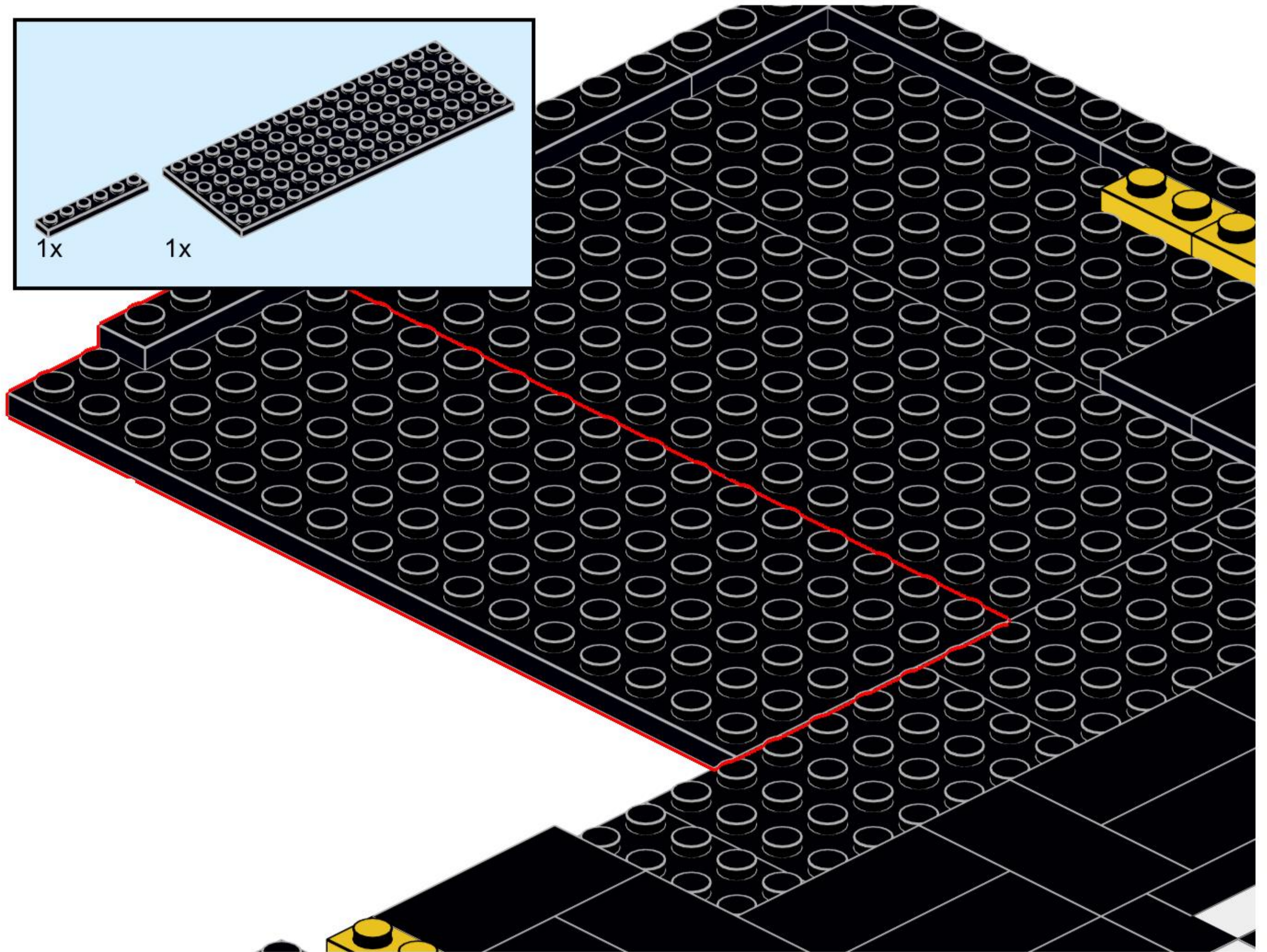
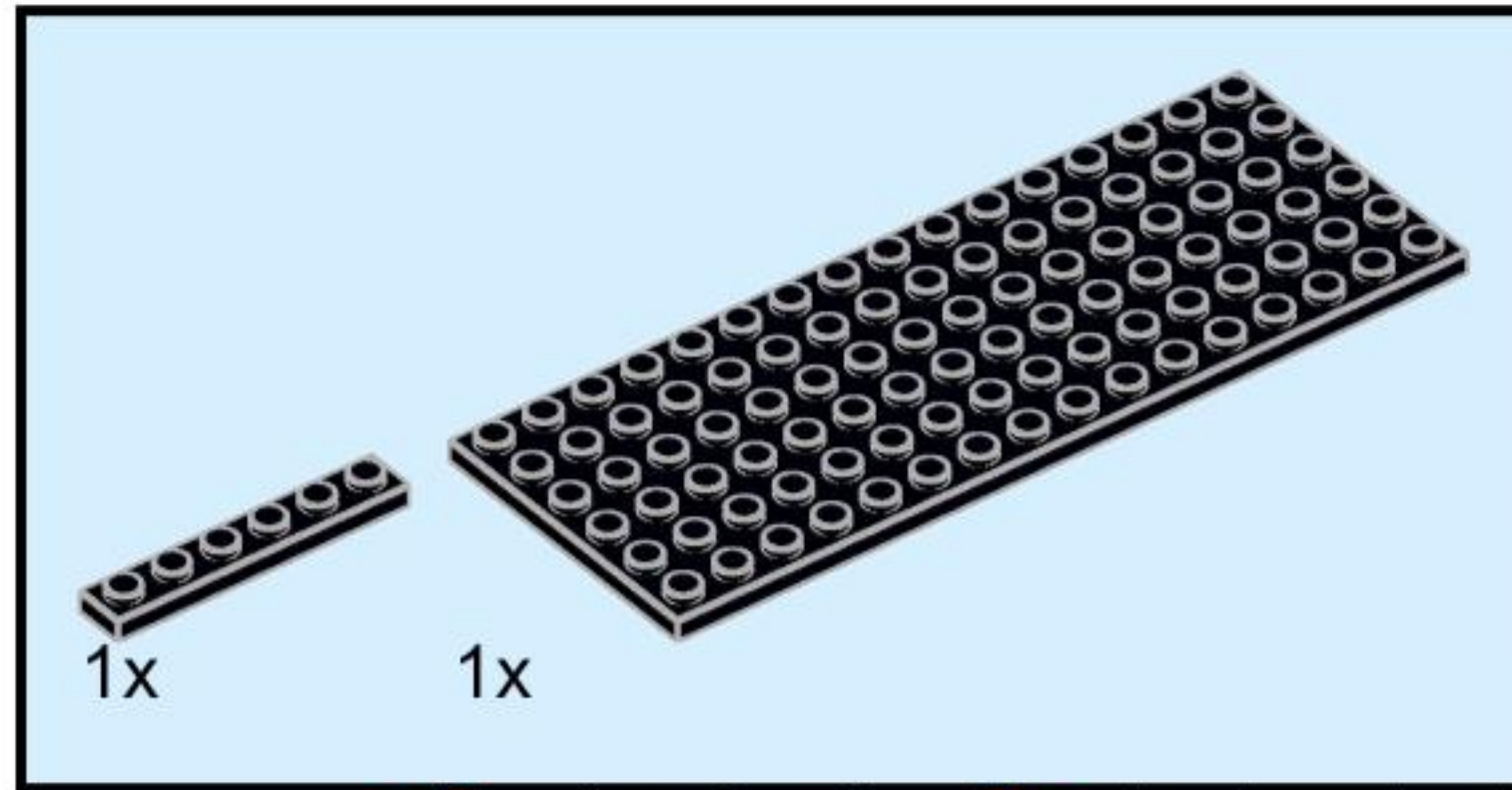

77

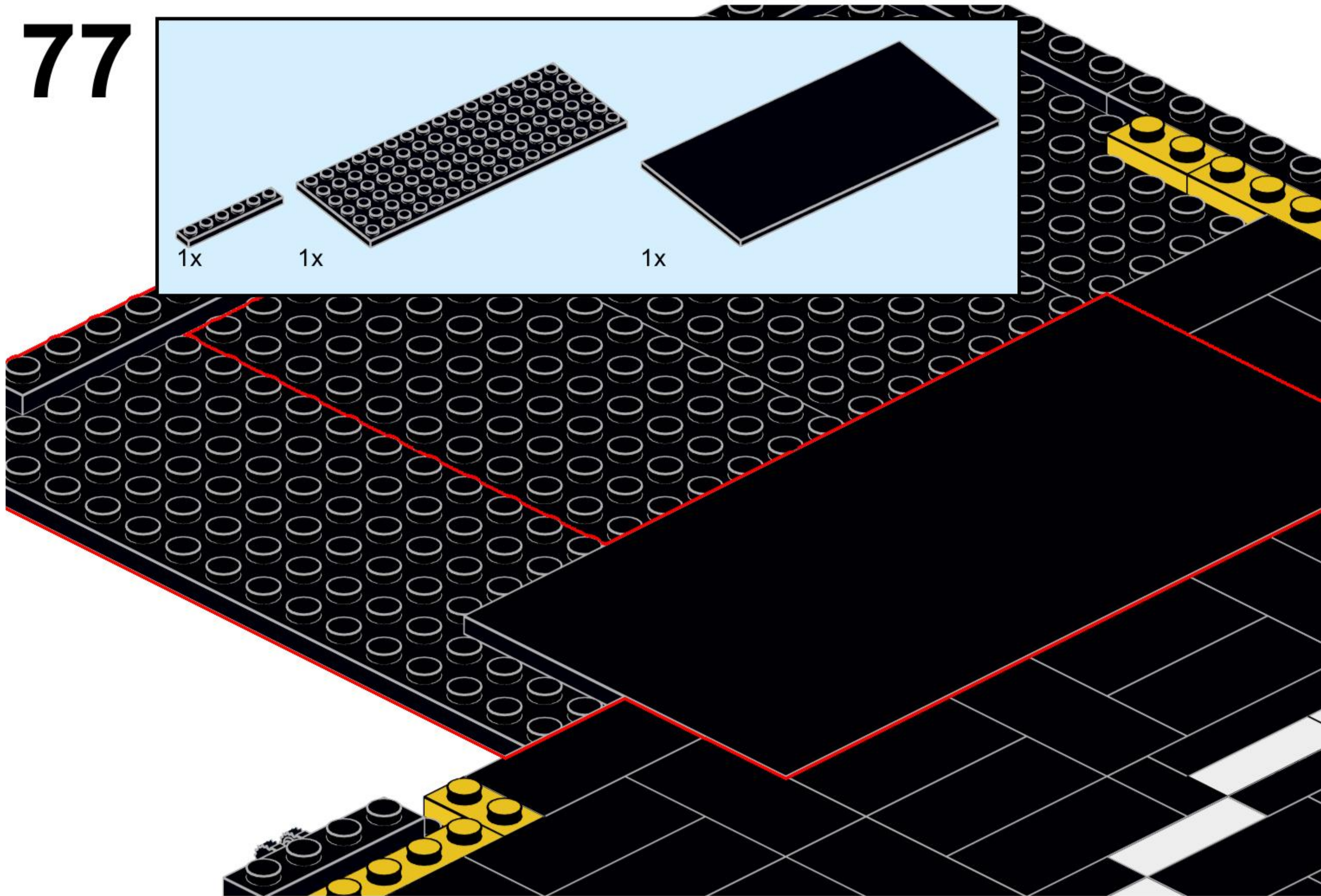
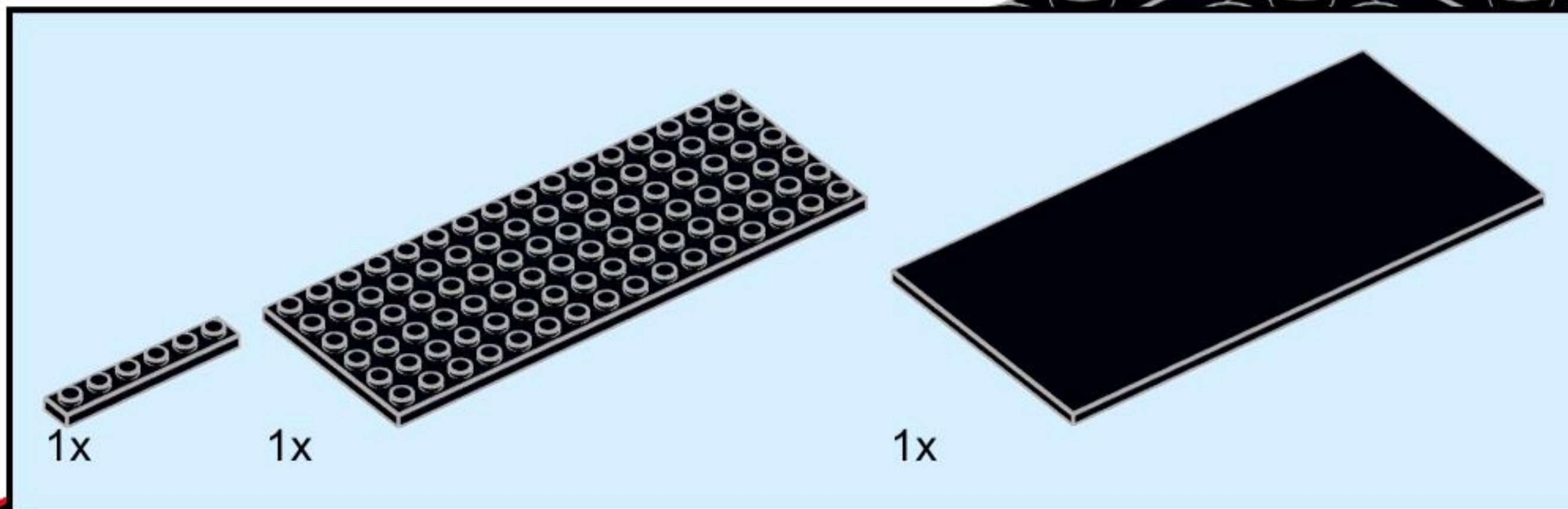

78

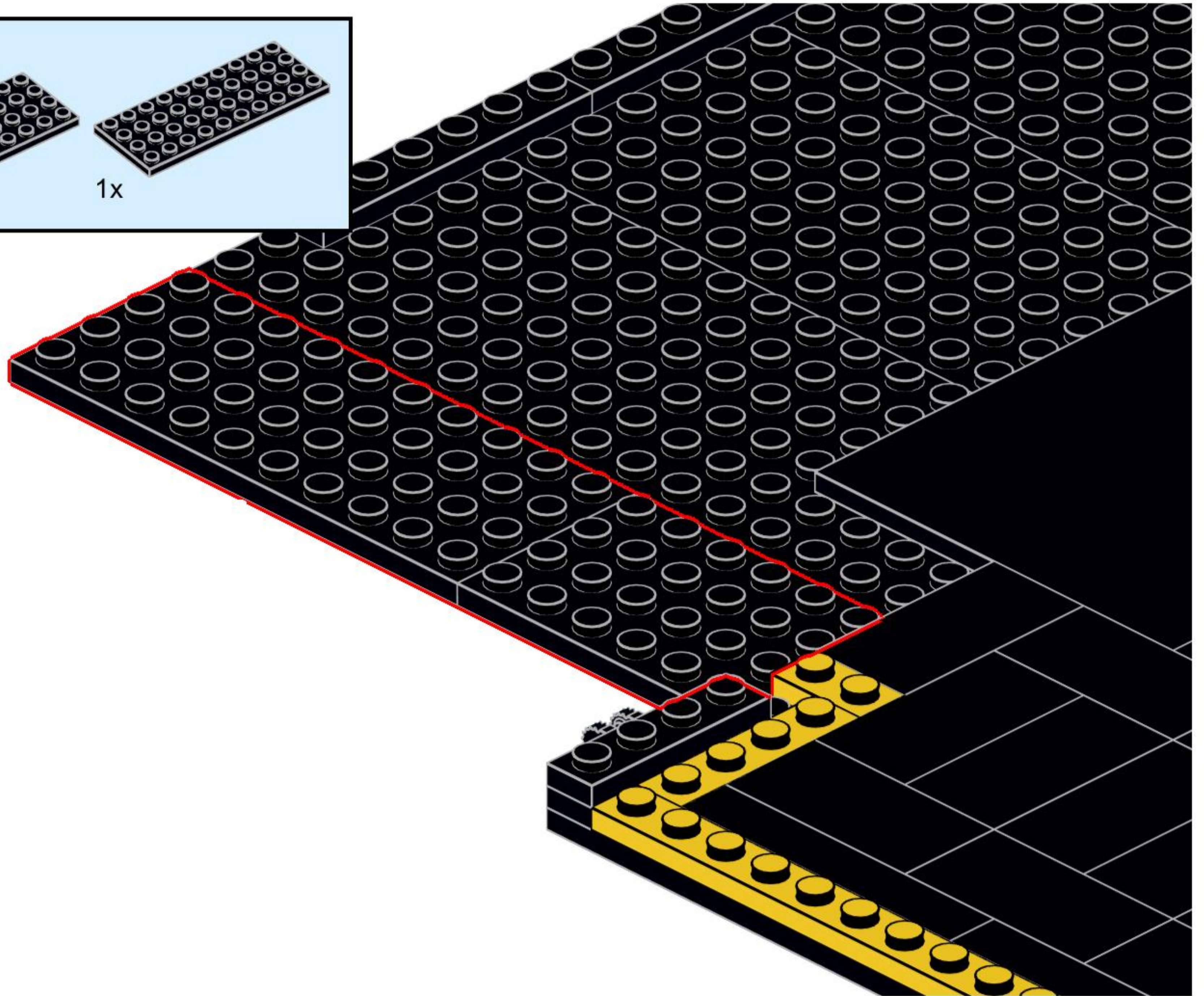
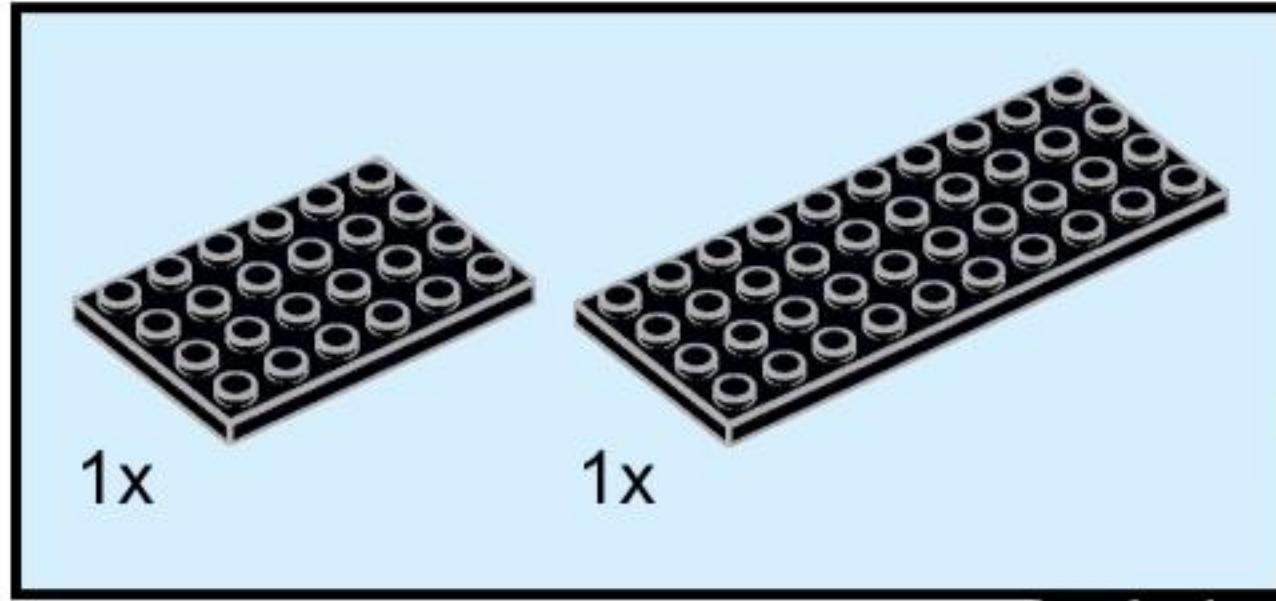

79

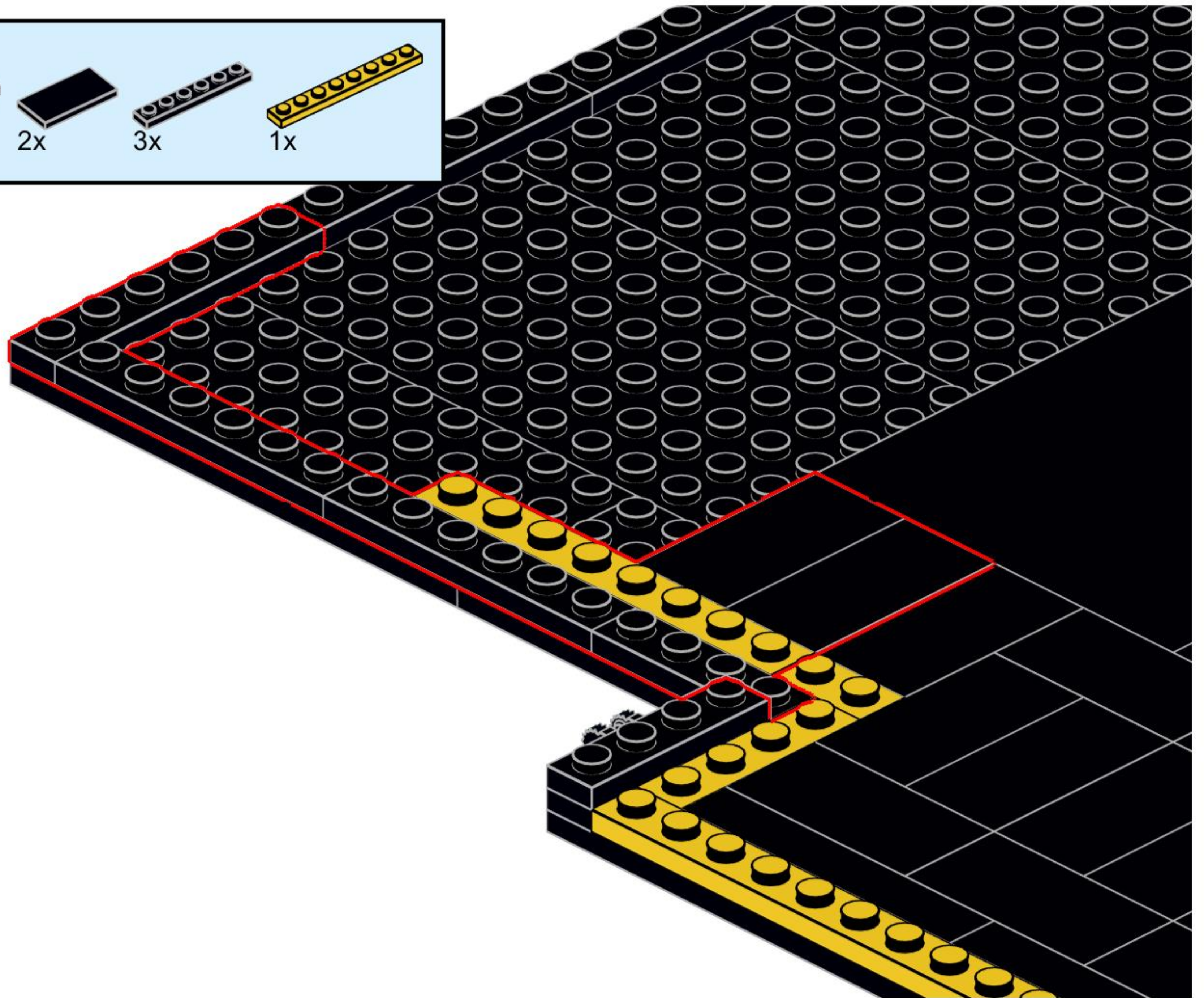
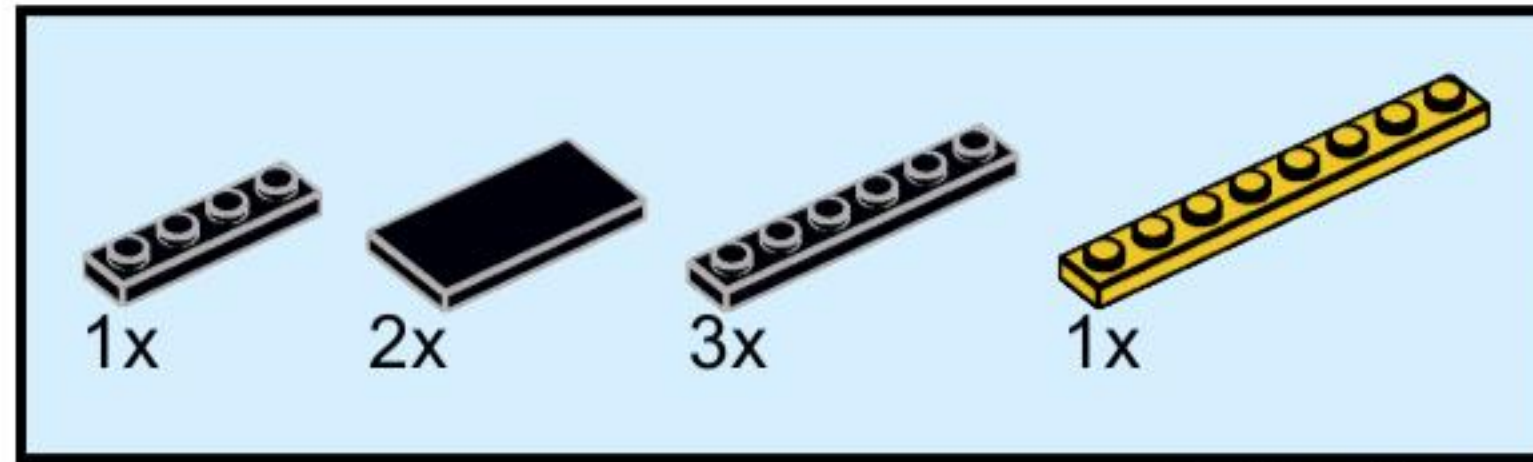

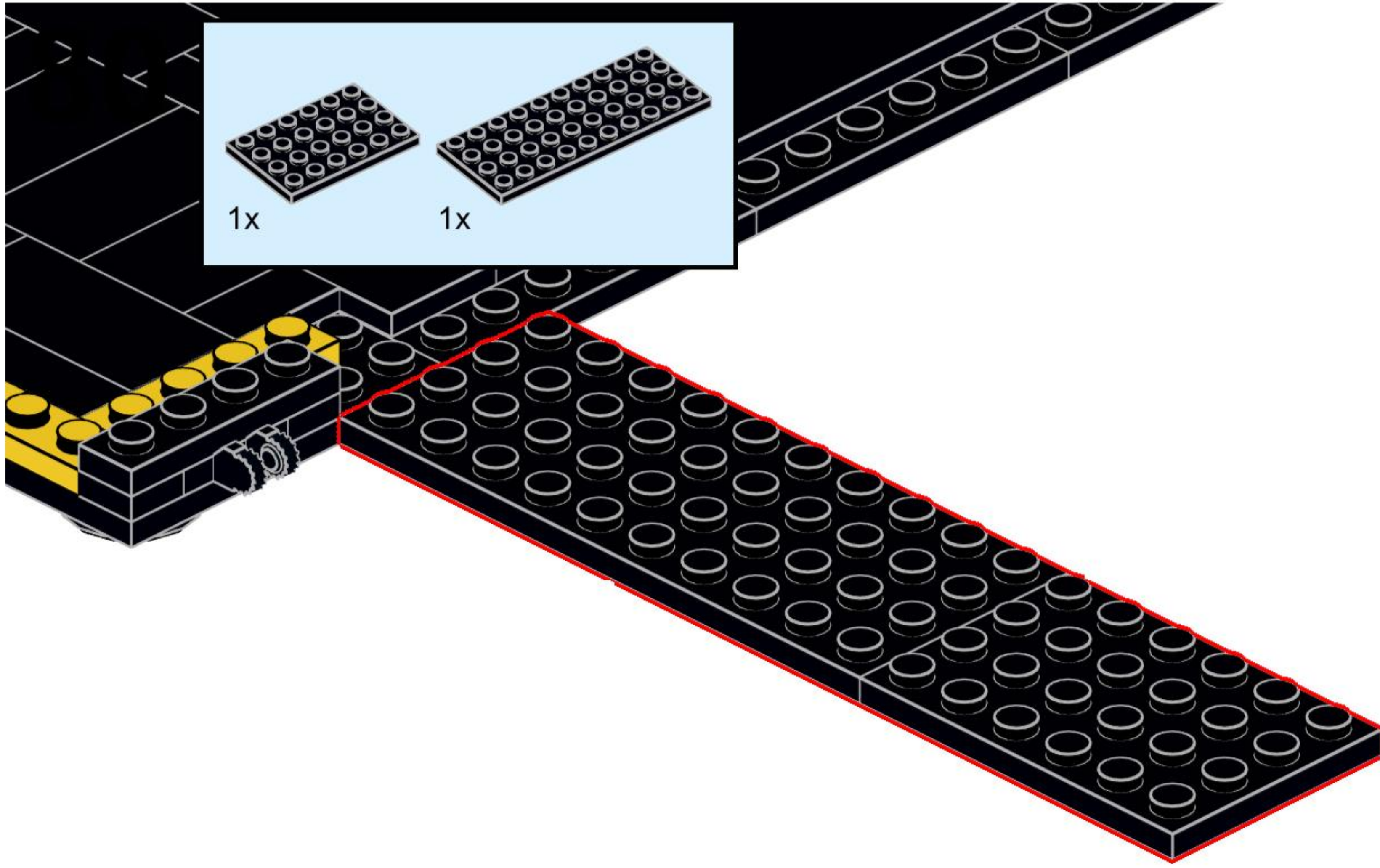

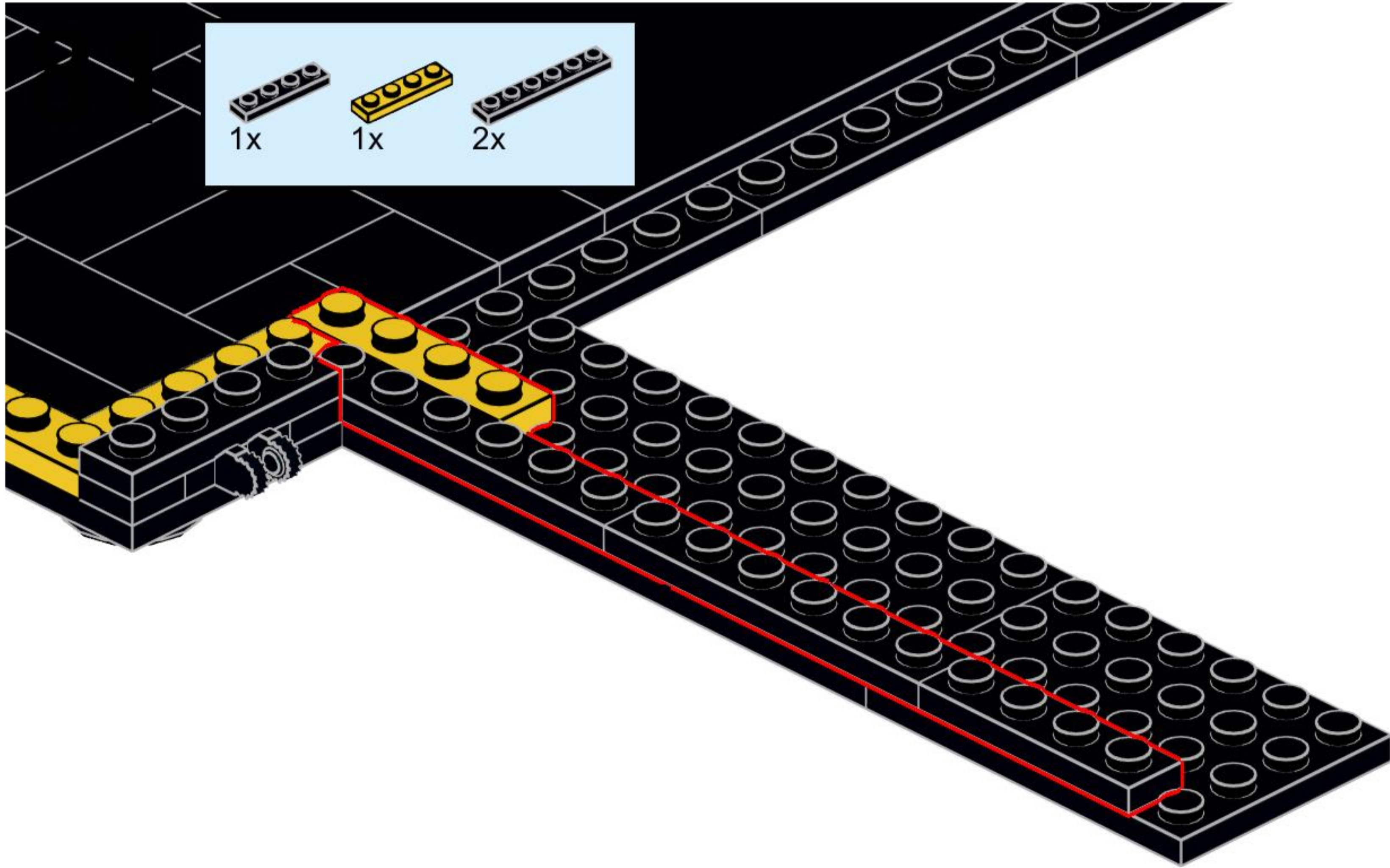

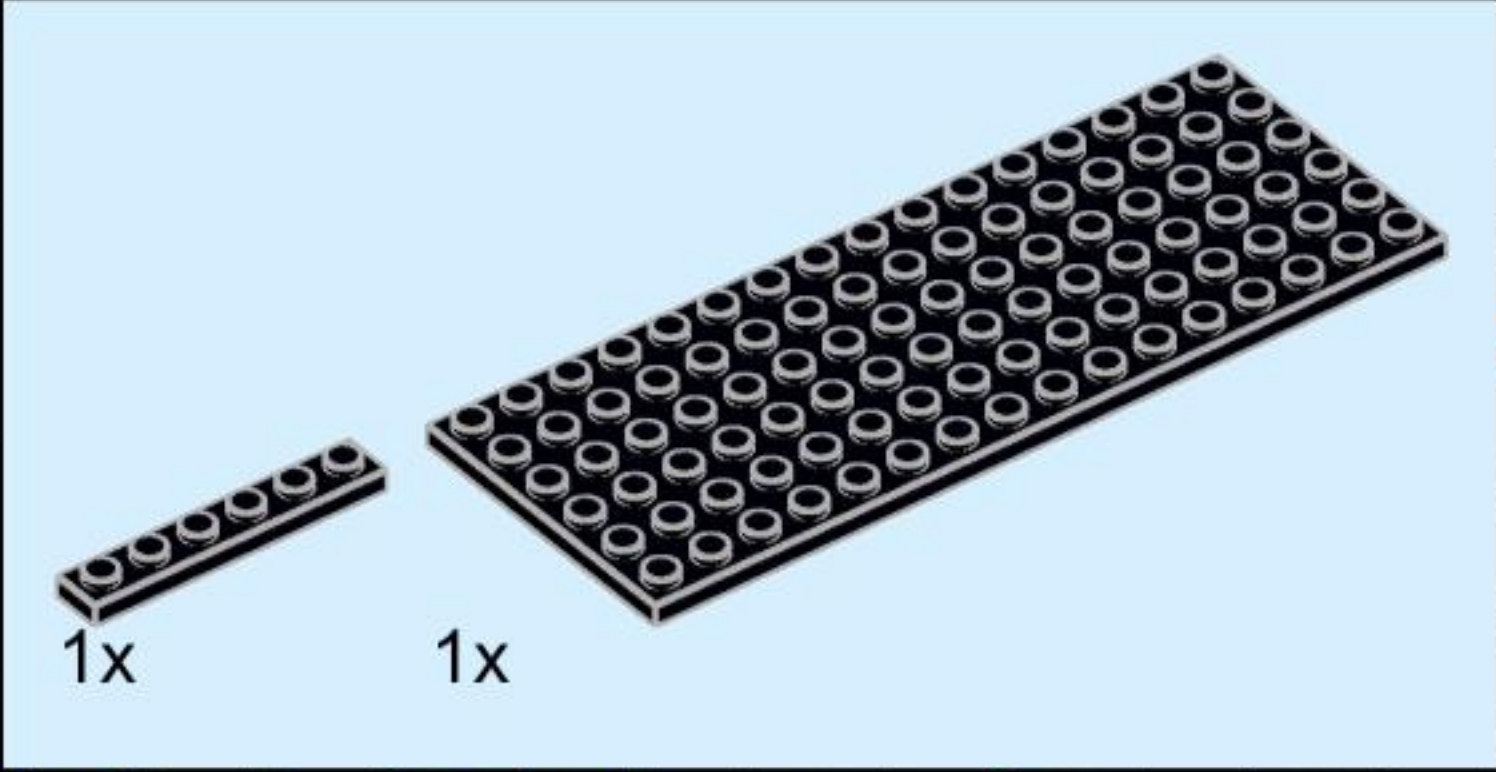
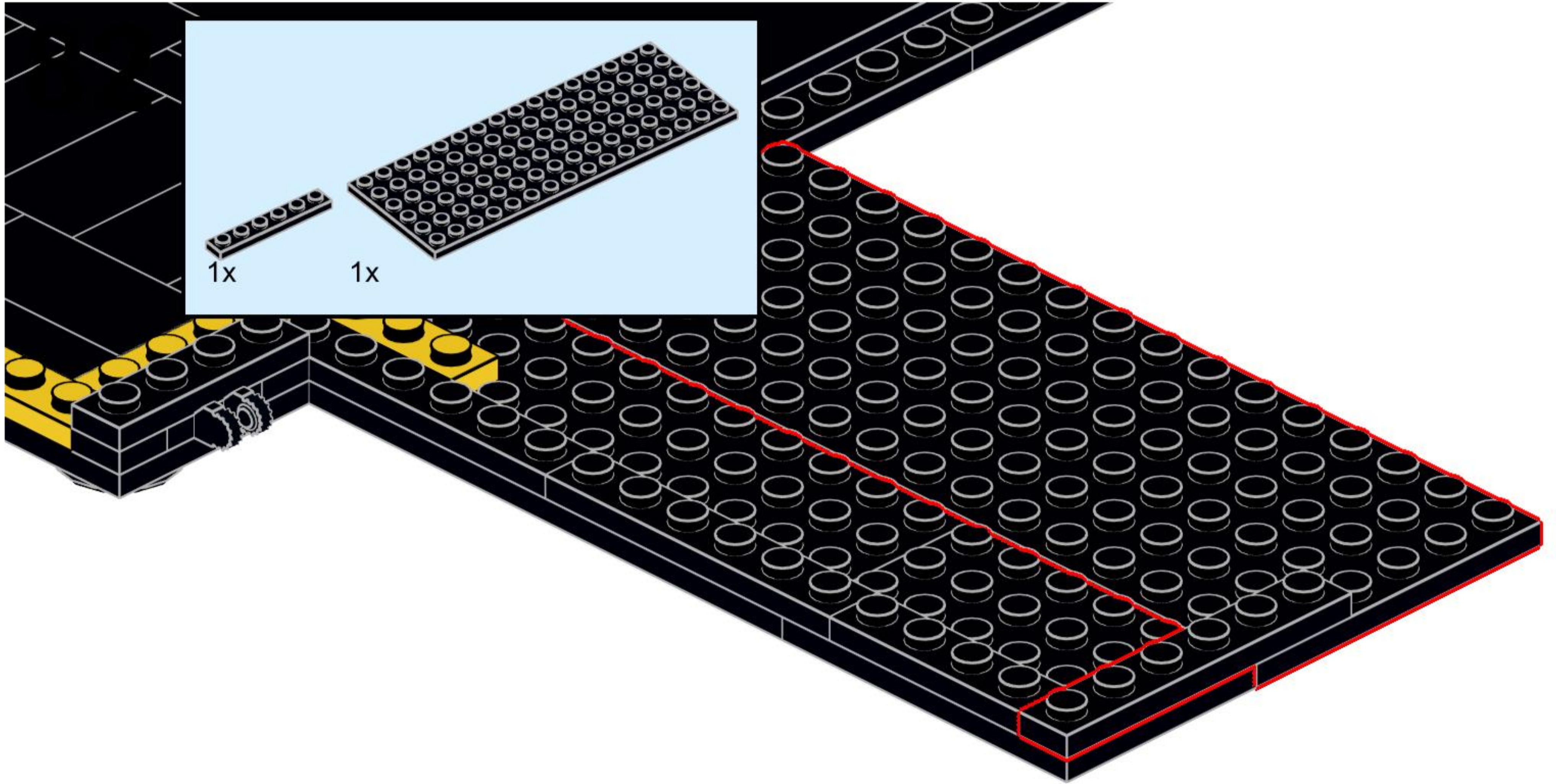

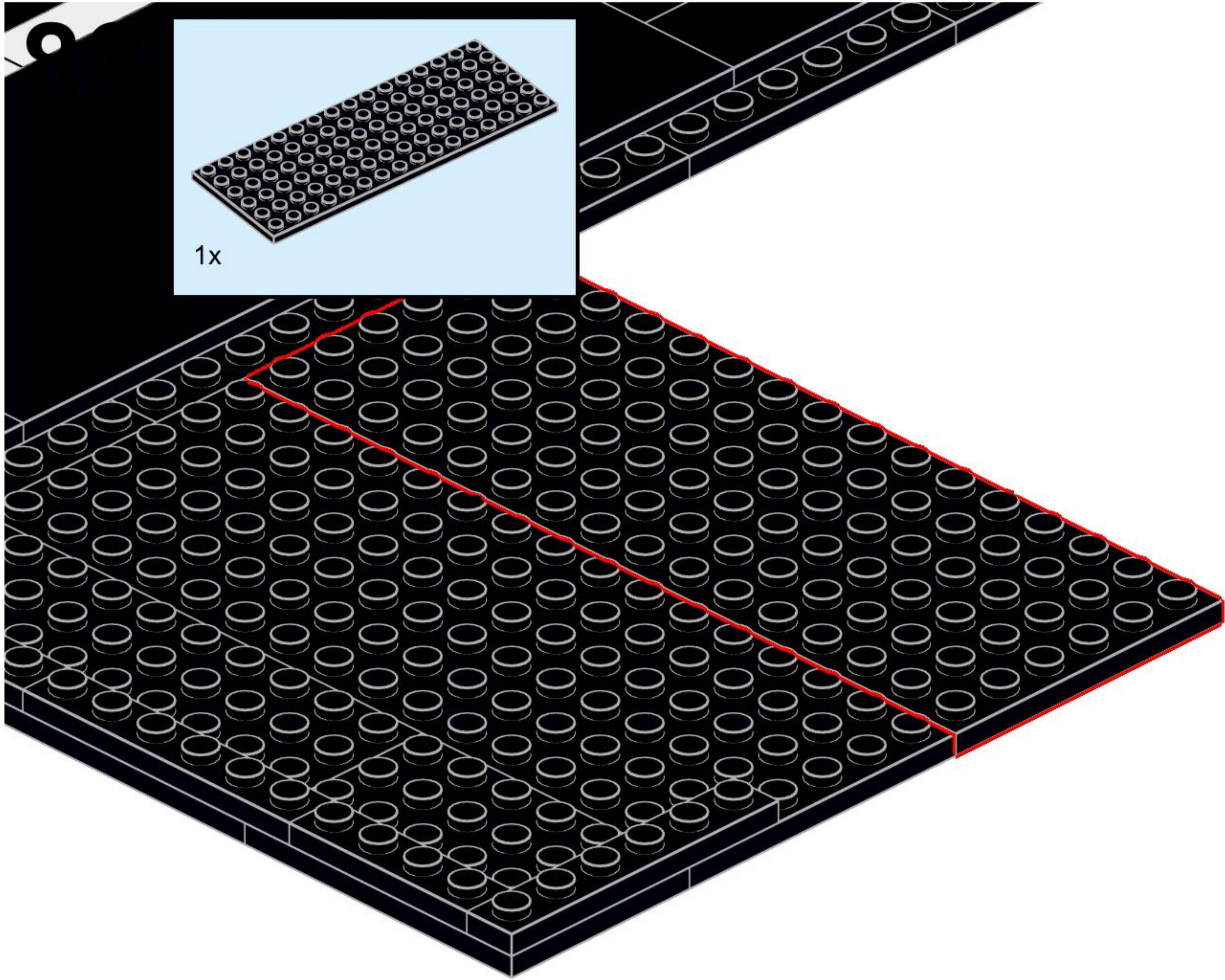

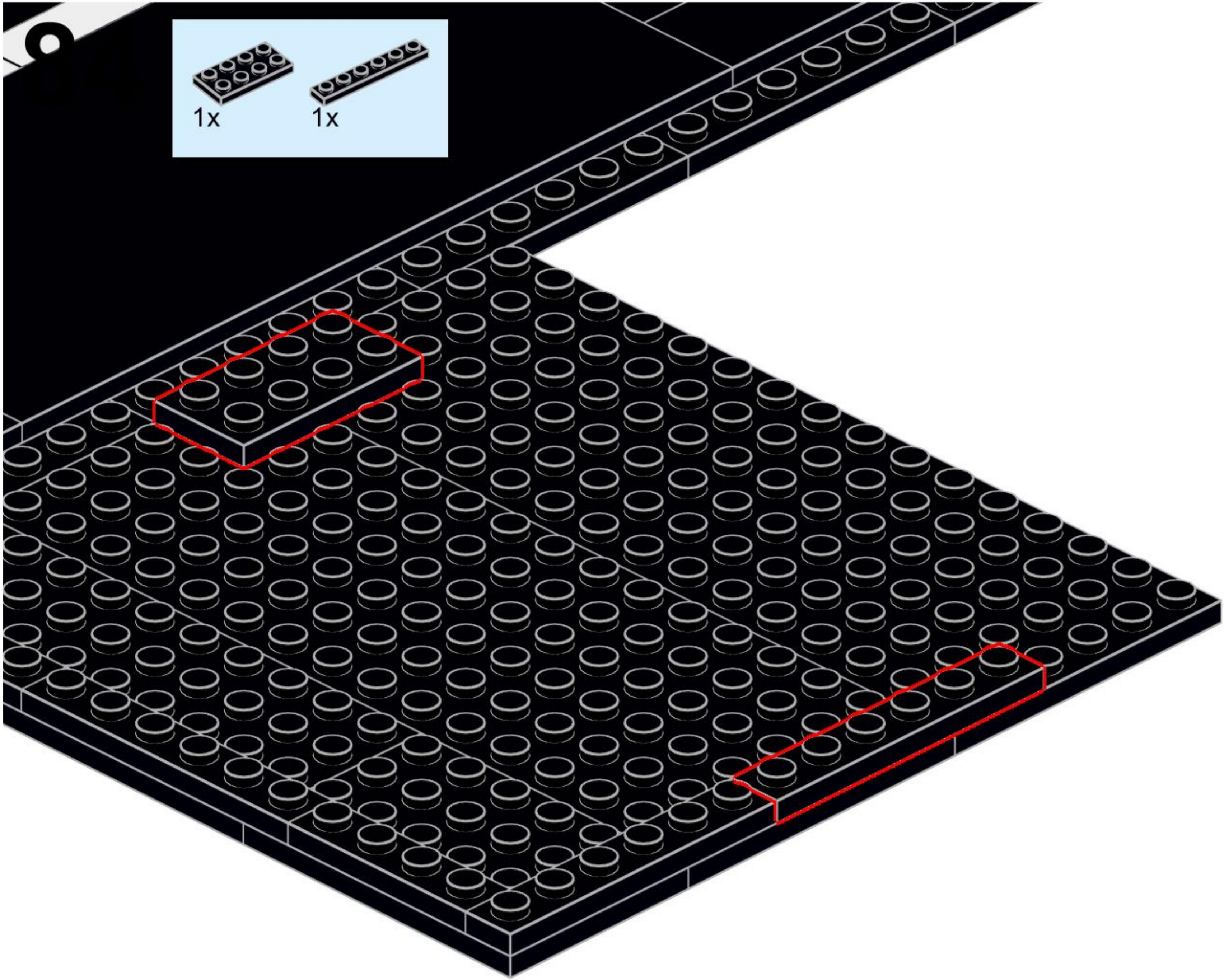
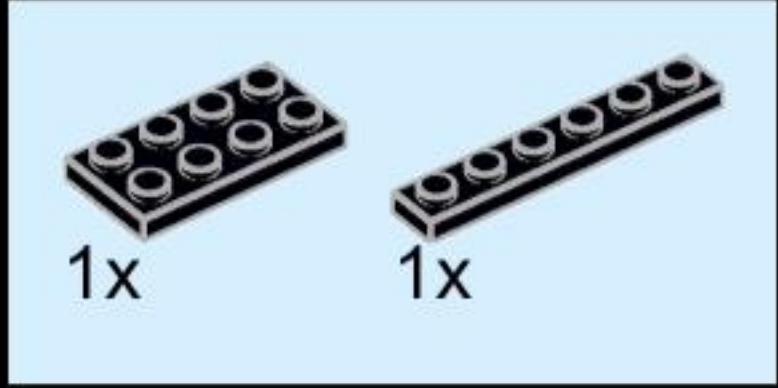

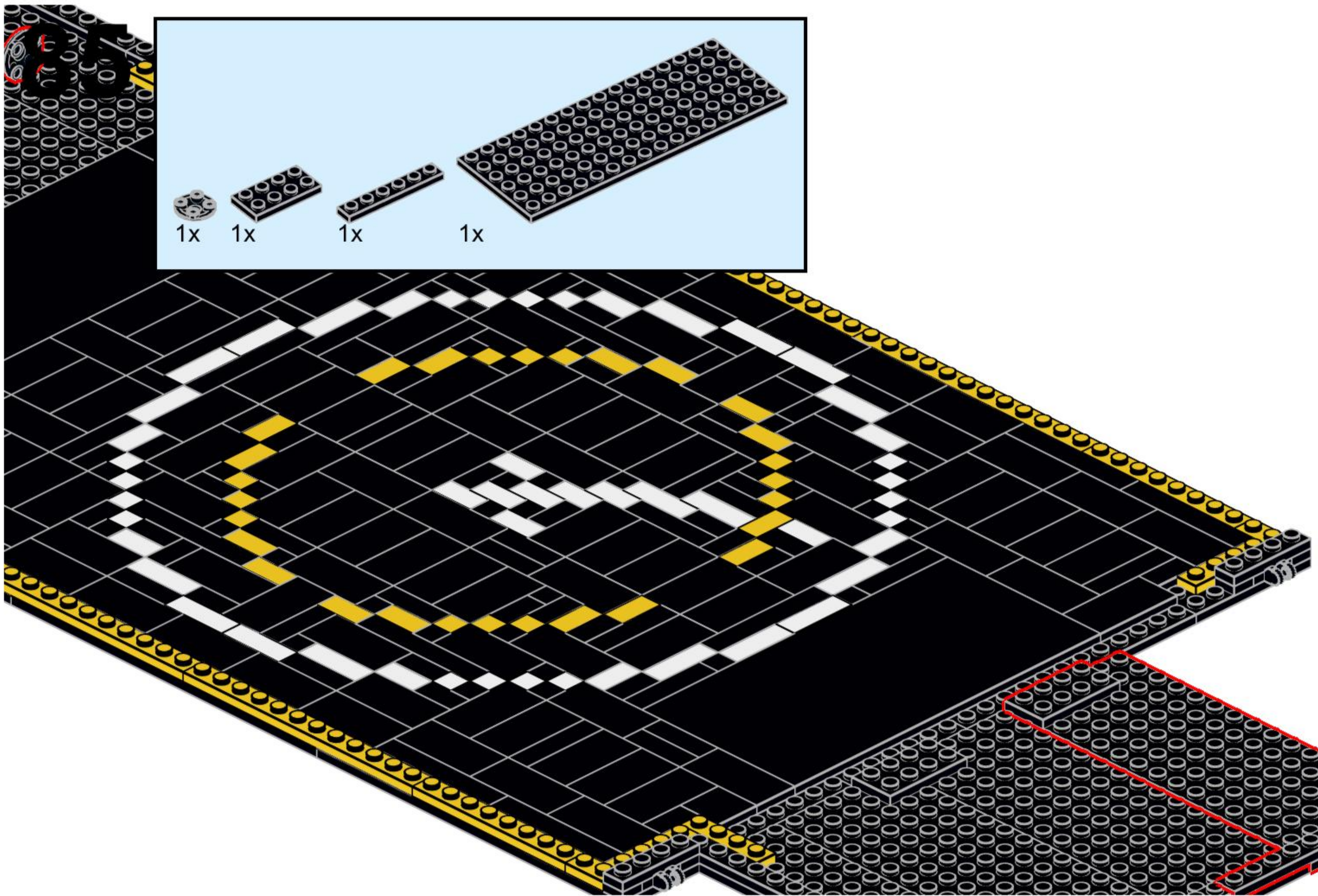

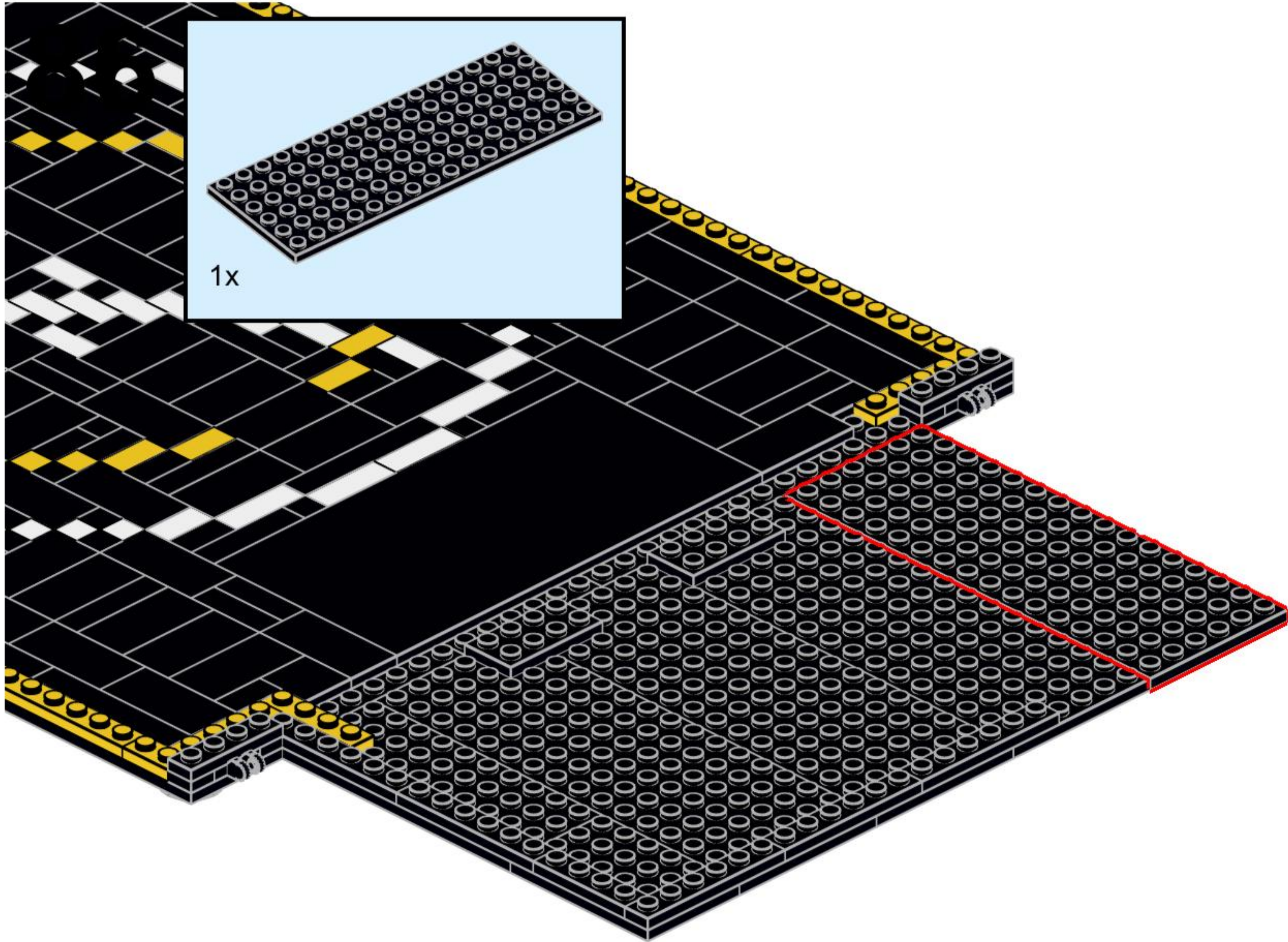

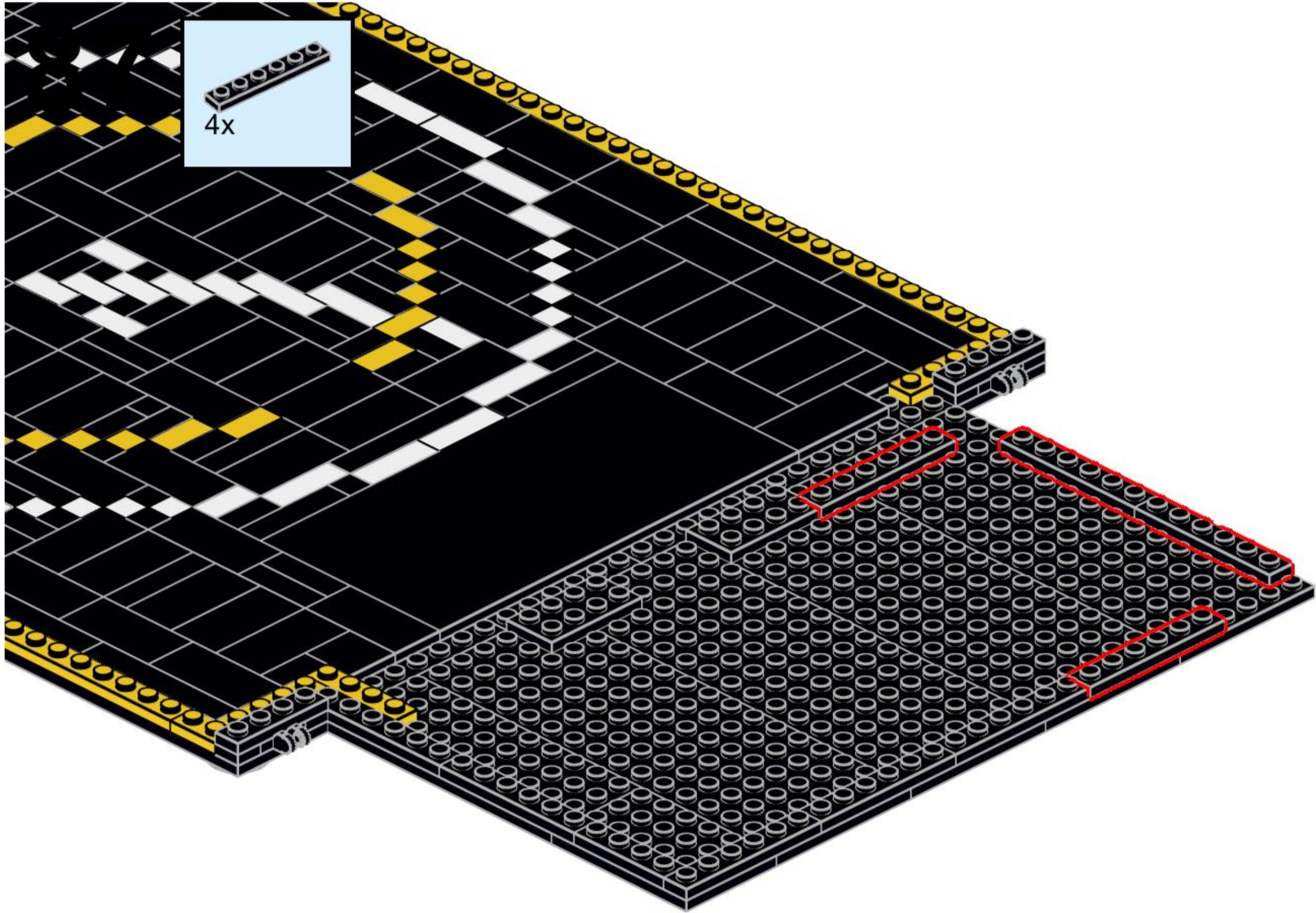

4x

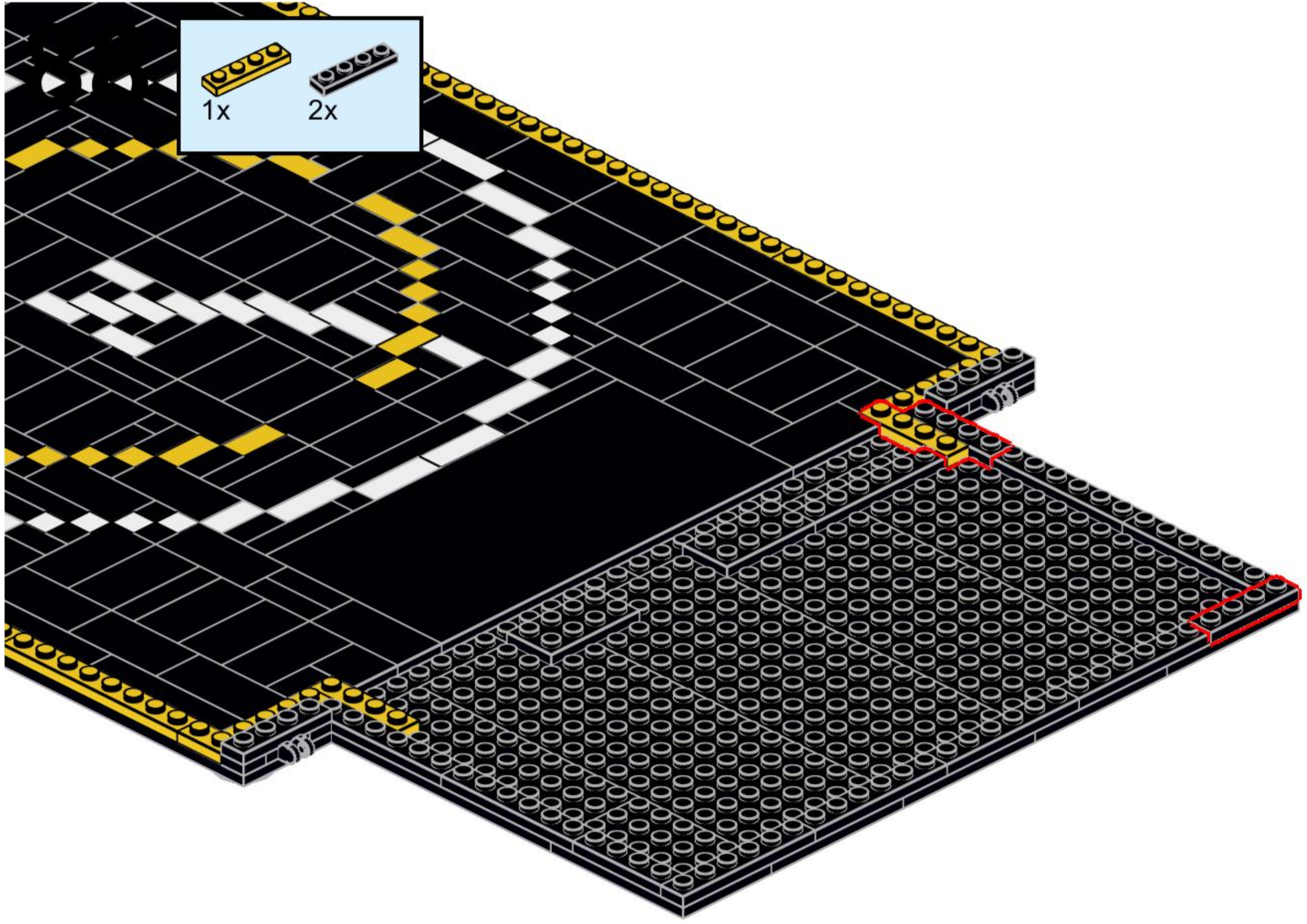

89

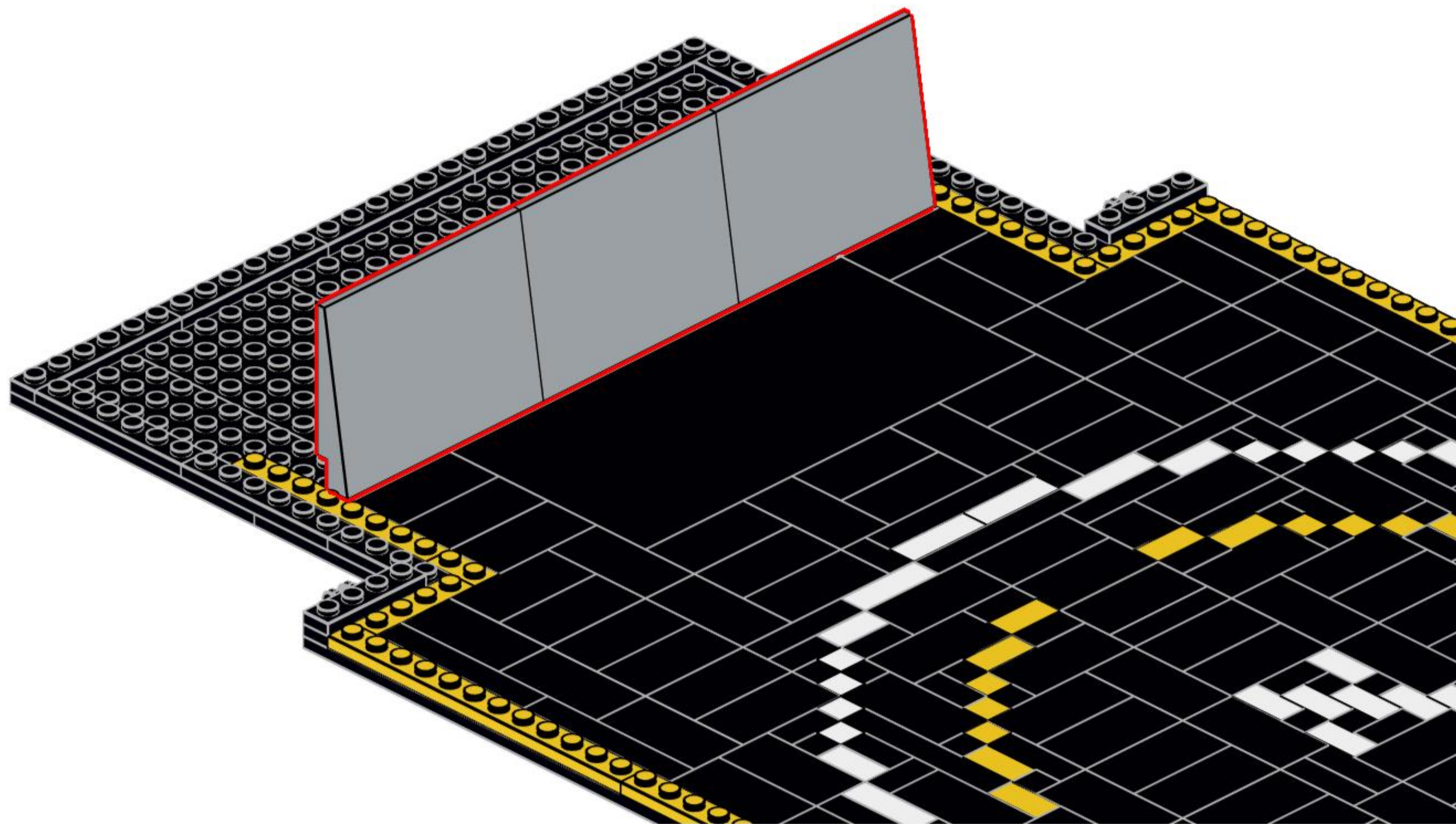
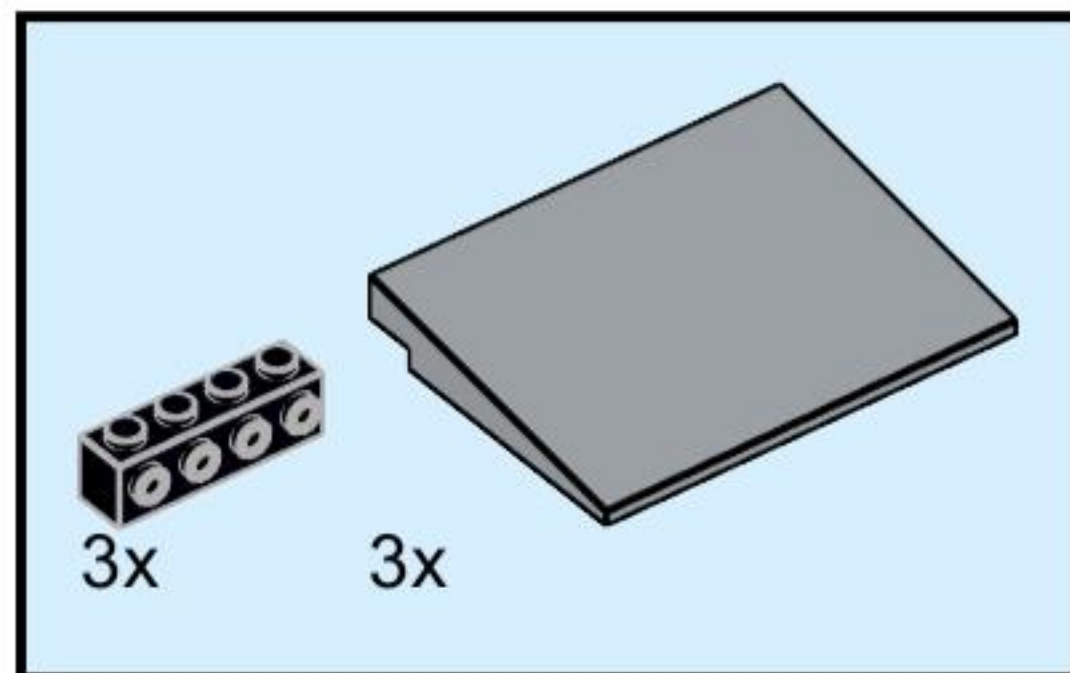

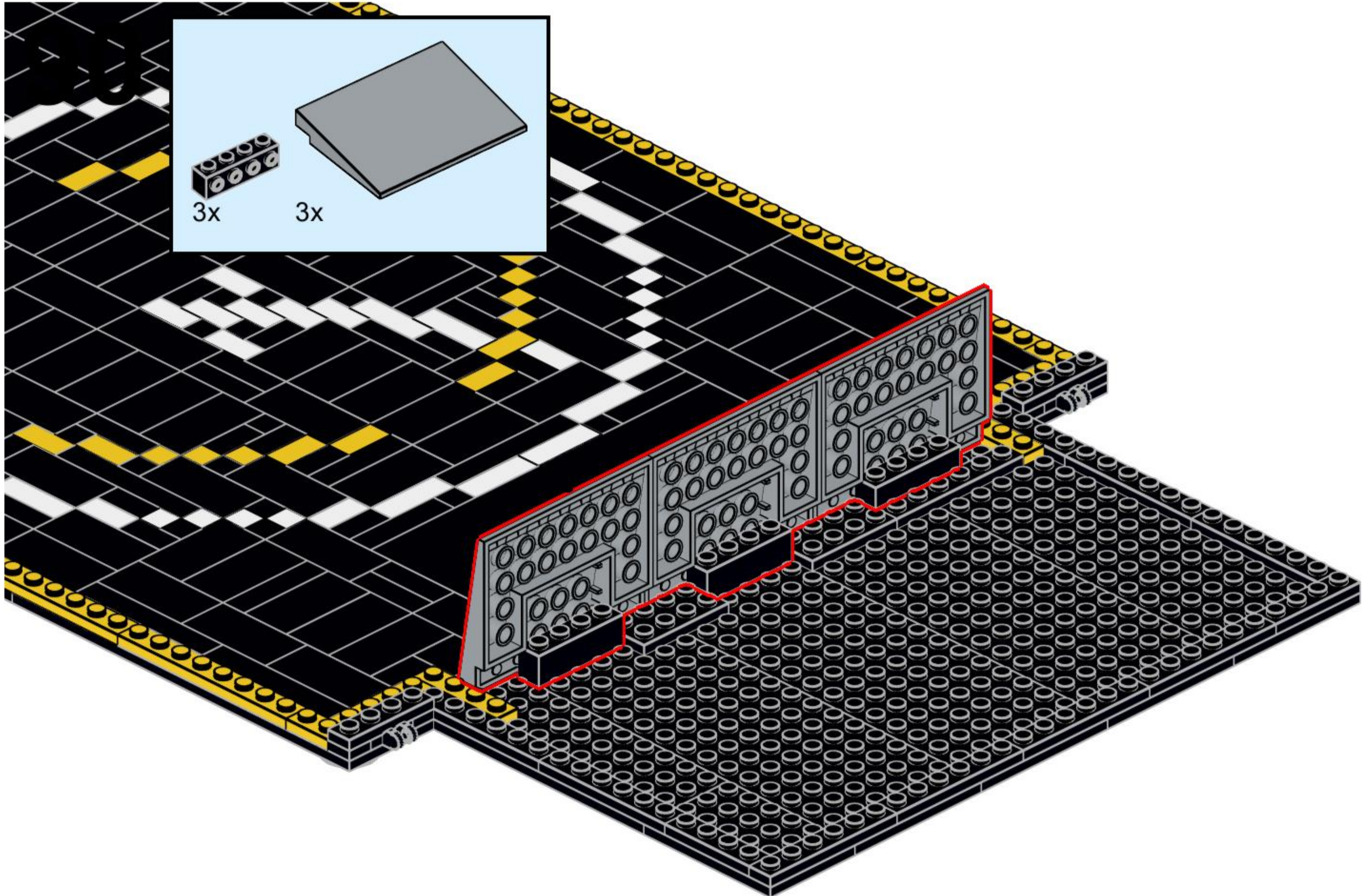

91

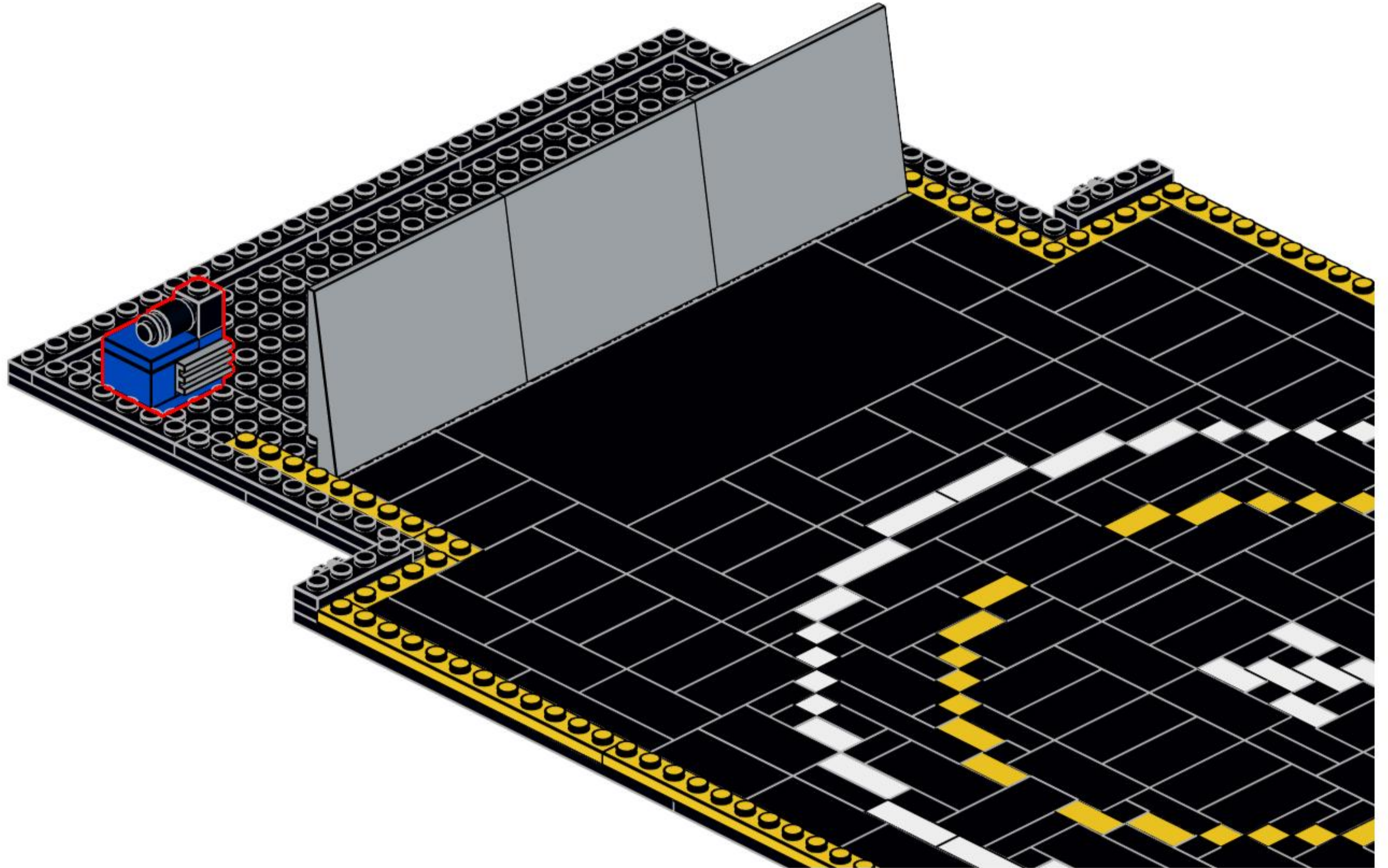
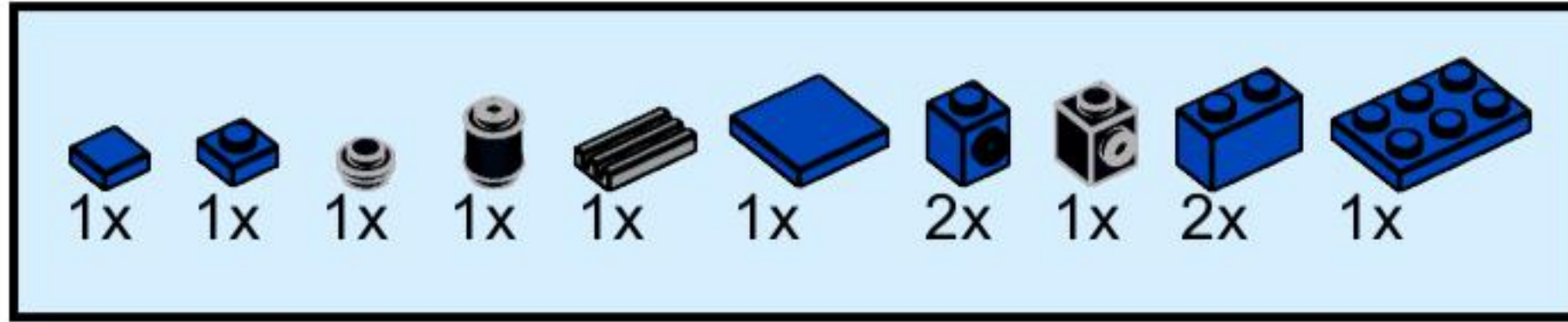

92

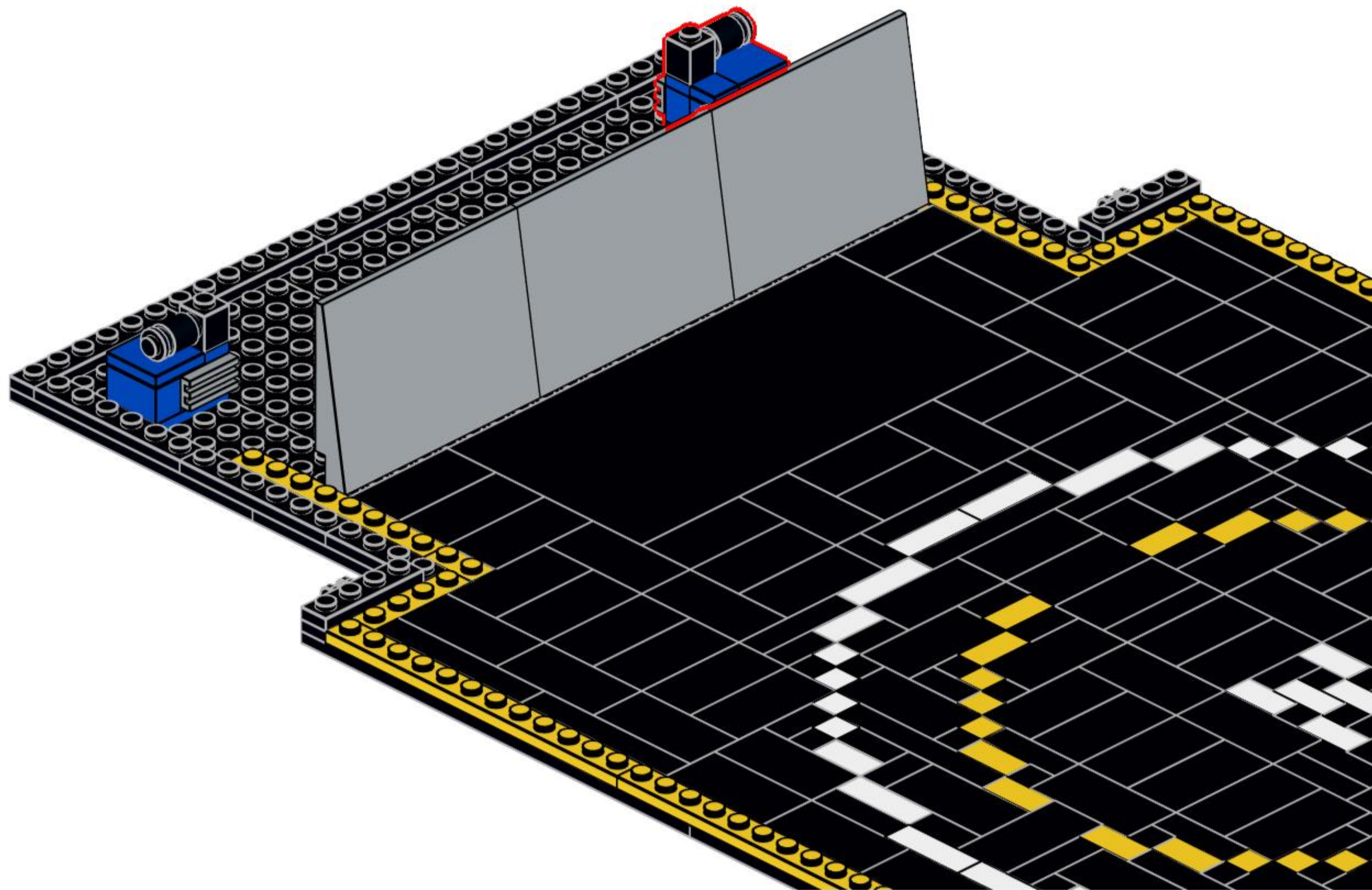
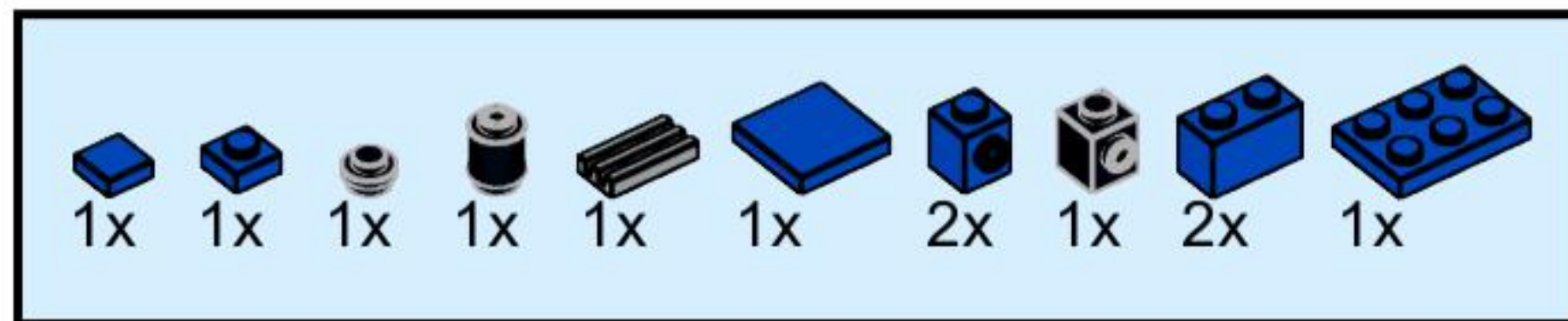

- 2x [1x1 black brick]
- 1x [1x1 grey brick]
- 2x [1x2 grey brick]
- 4x [1x2 white brick]
- 1x [1x2 black brick]
- 2x [1x3 grey brick]
- 4x [1x3 white brick]
- 1x [1x4 black brick]
- 2x [1x4 white brick]
- 1x [1x4 grey brick]
- 3x [1x5 white brick]
- 3x [1x5 grey brick]
- 2x [1x6 grey brick]

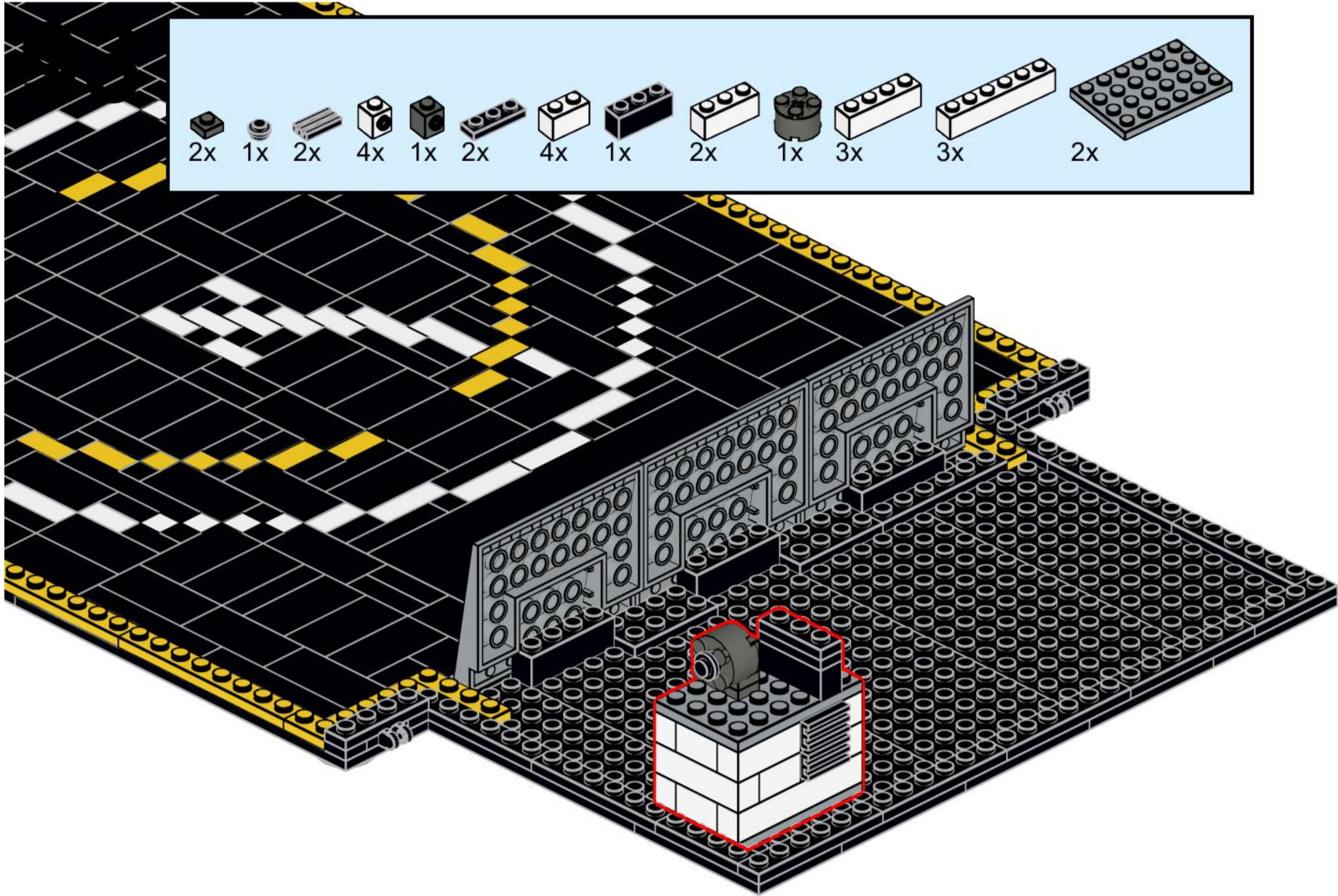

- 2x [1x1 black brick]
- 1x [1x1 grey brick]
- 2x [1x2 grey brick]
- 4x [1x1 white brick]
- 1x [1x1 black brick]
- 2x [1x2 black brick]
- 4x [1x2 white brick]
- 1x [1x3 black brick]
- 2x [1x3 white brick]
- 1x [1x3 grey brick]
- 3x [1x3 white brick]
- 3x [1x3 black brick]
- 2x [4x4 grey plate]

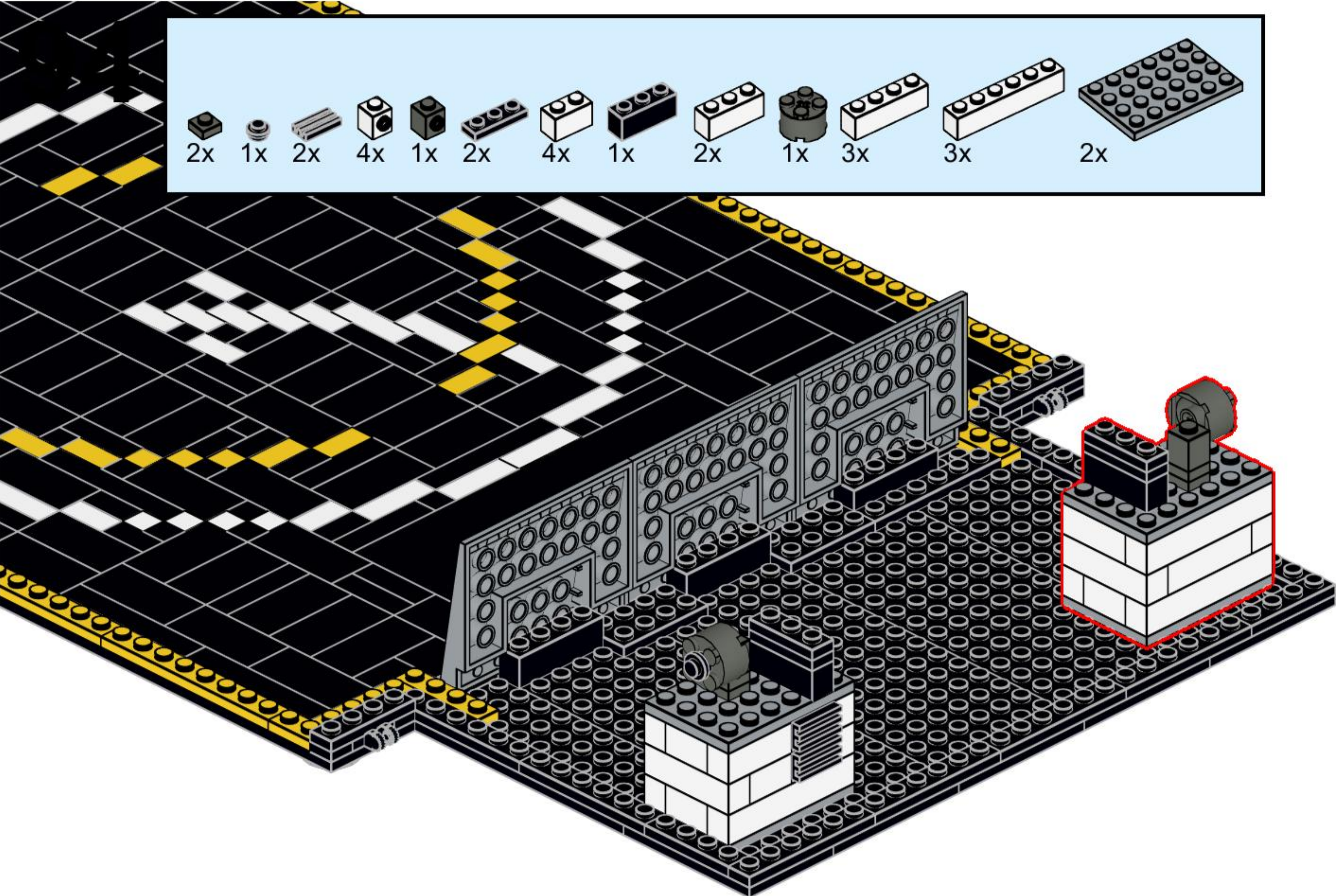

95

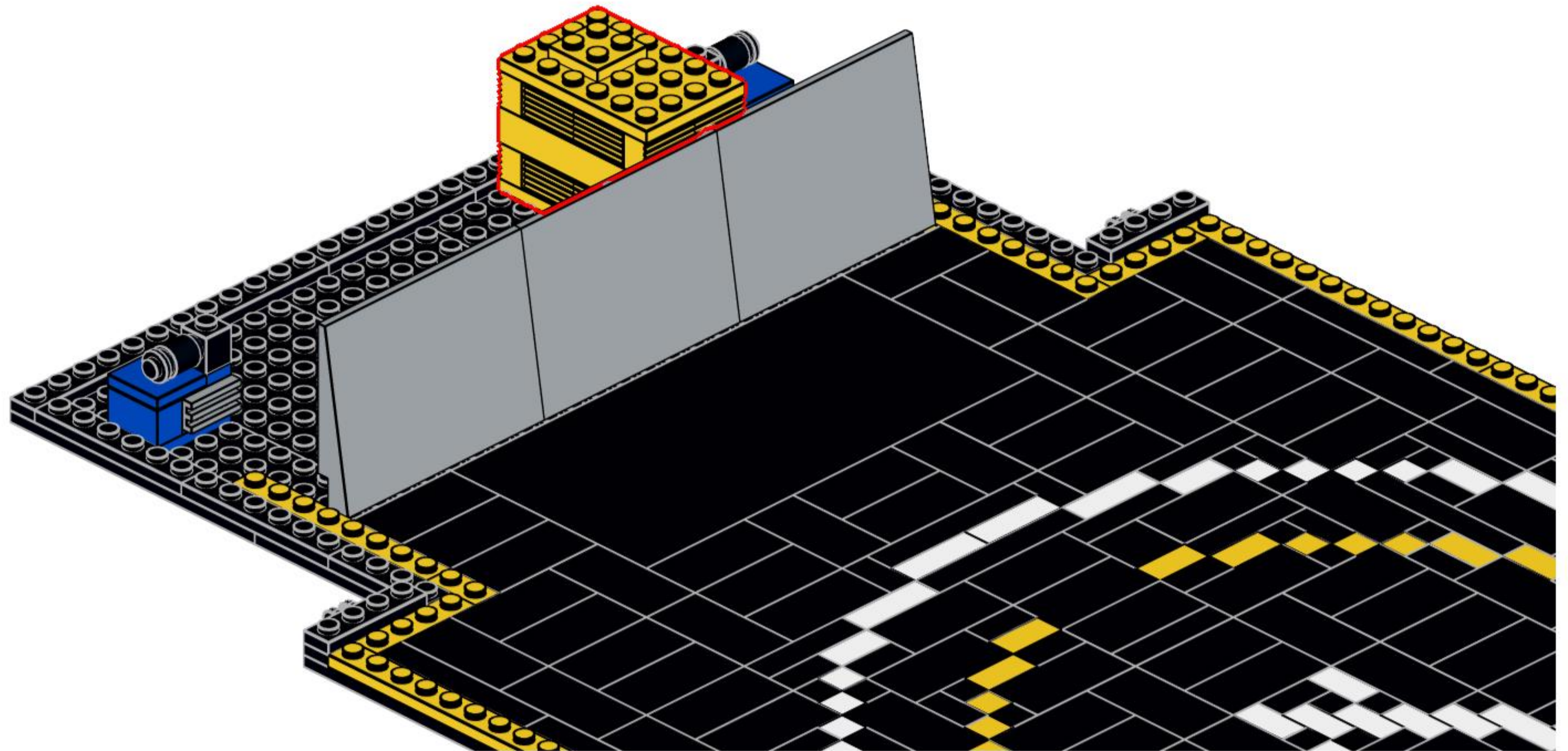
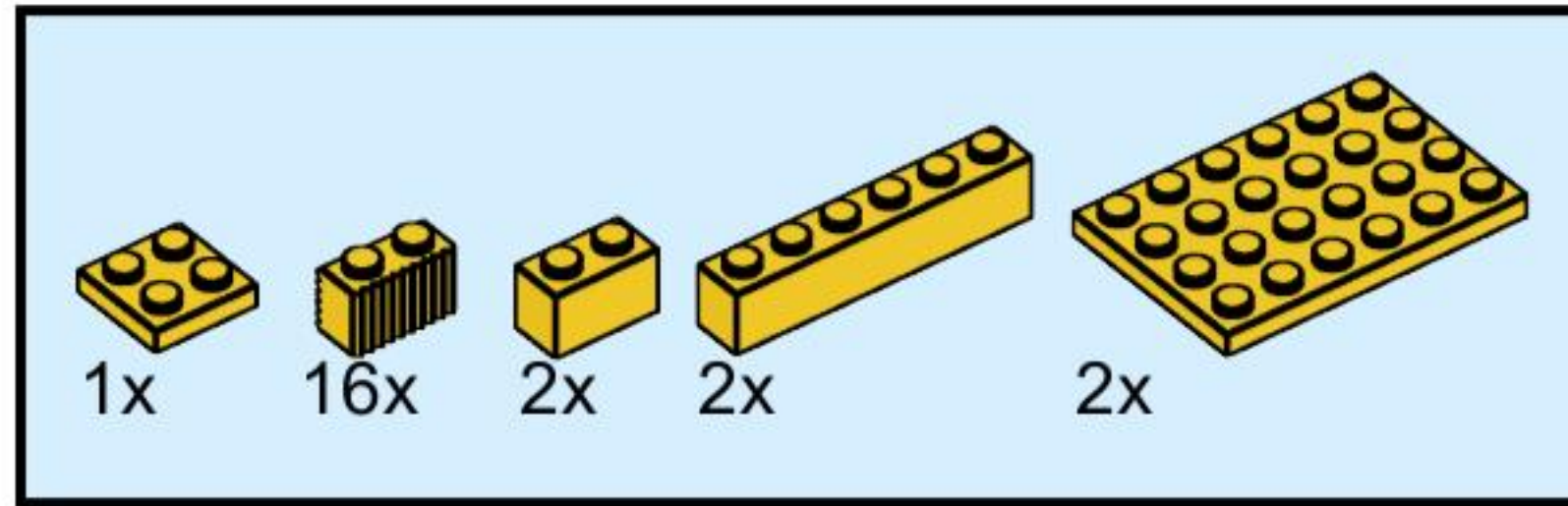

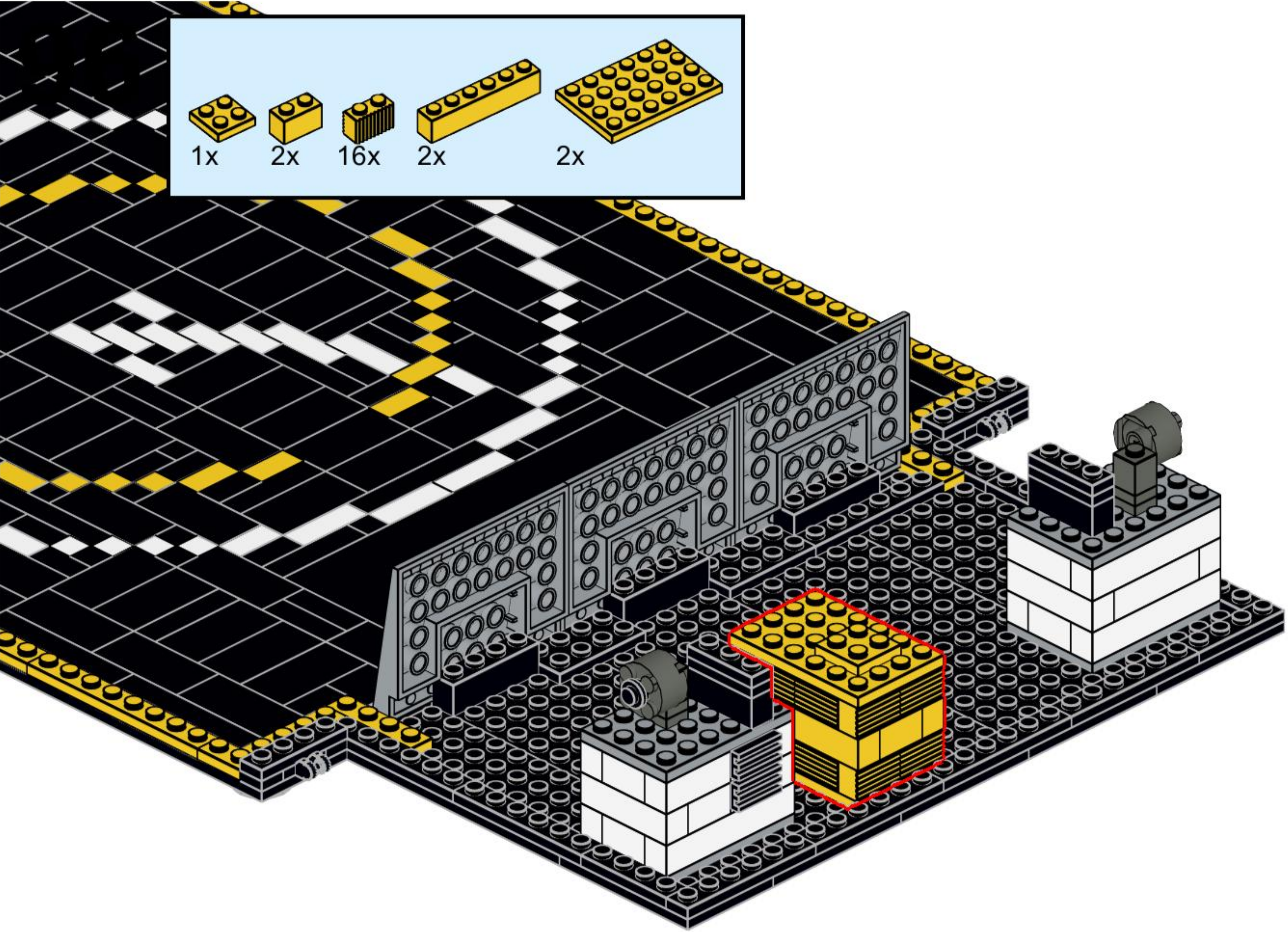
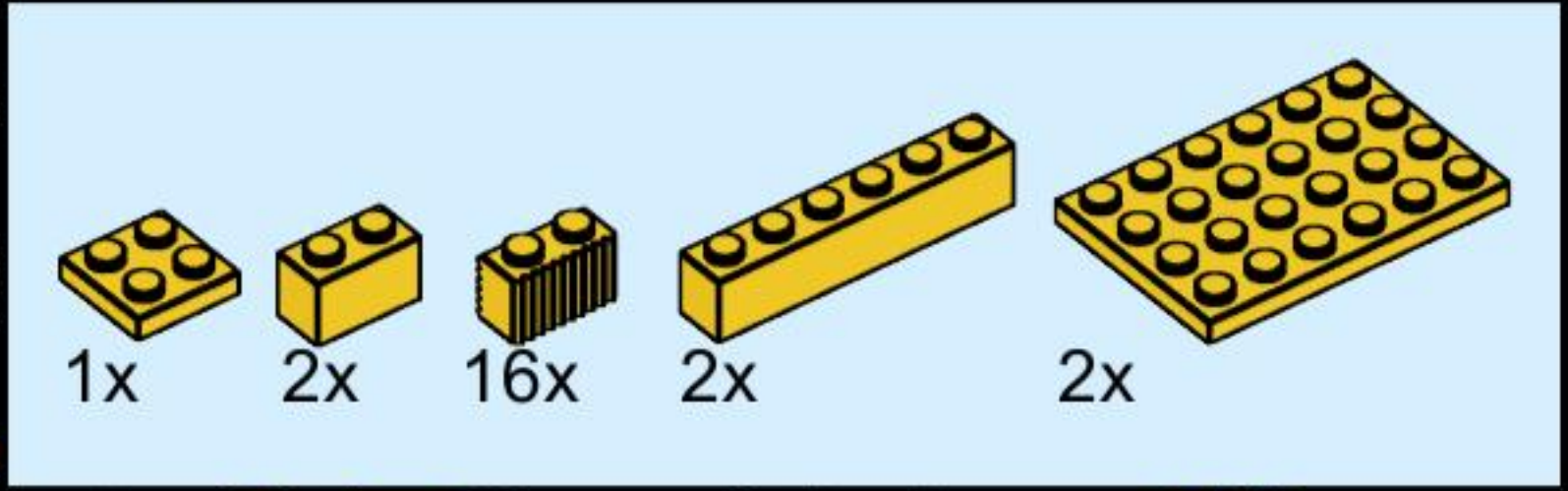

97

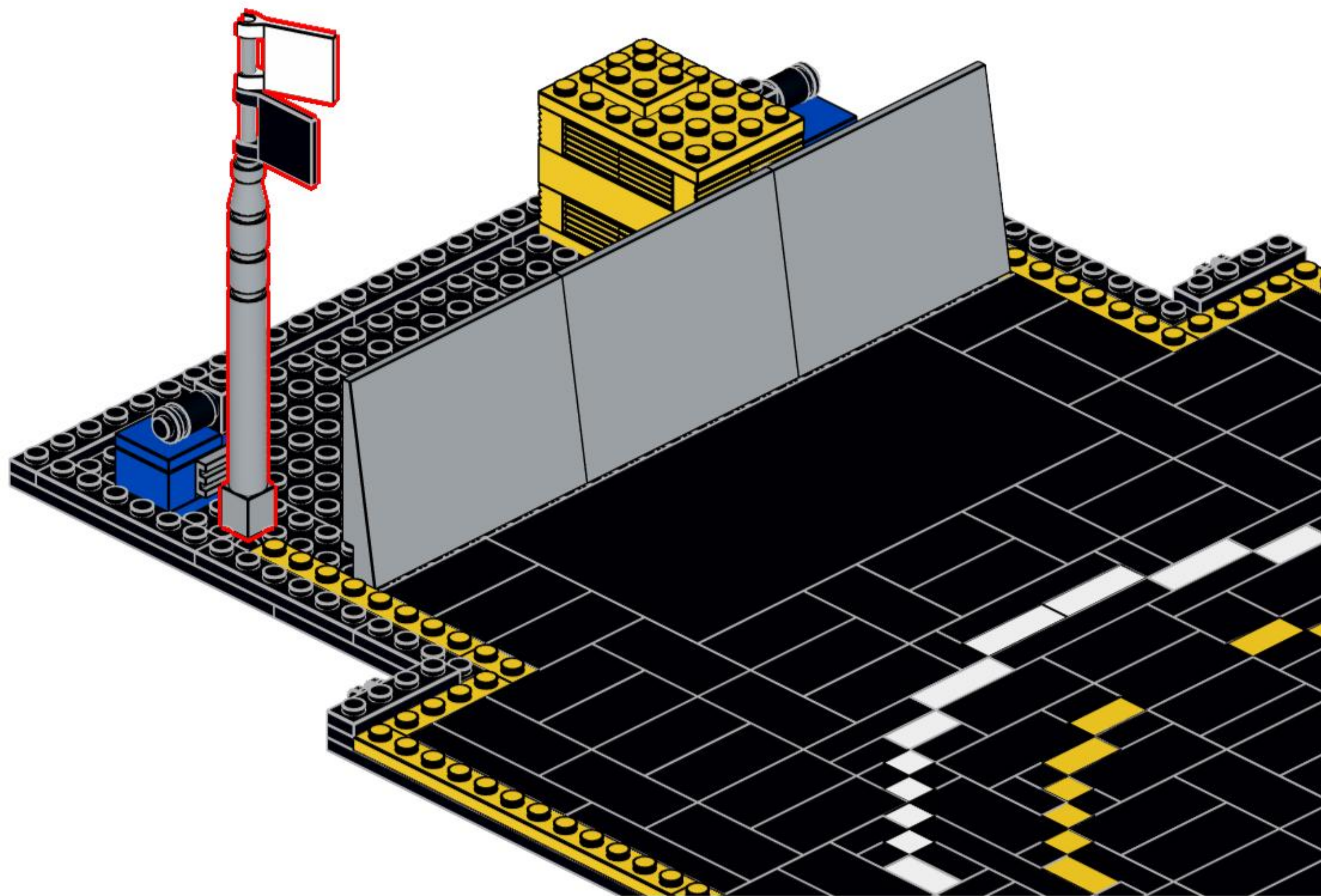
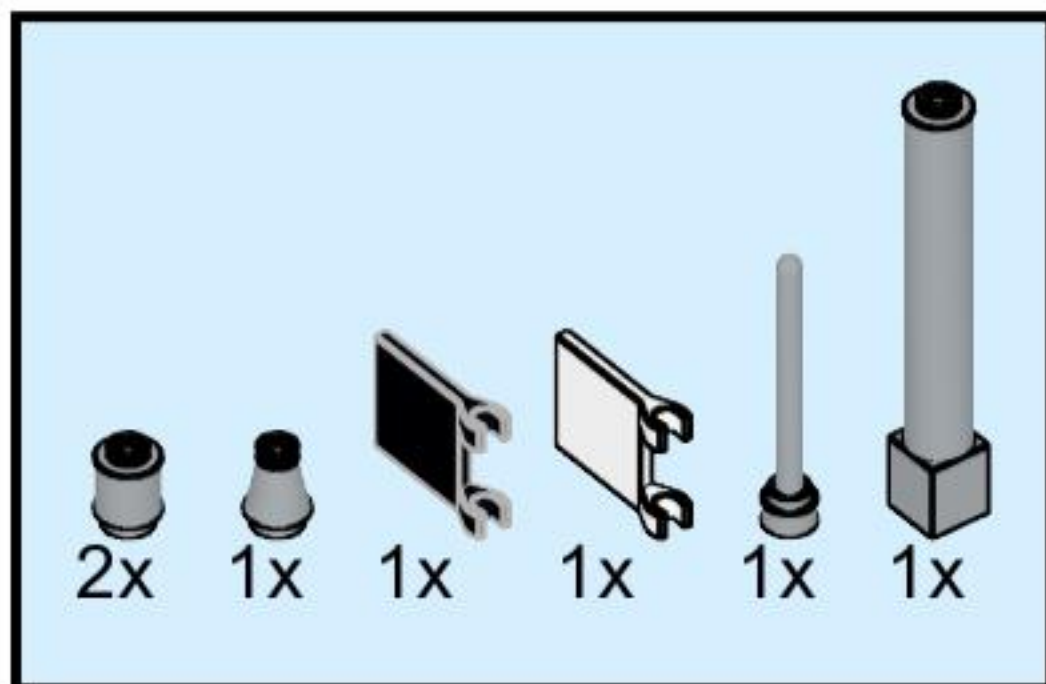

4x 8x 2x 2x 4x 1x 48x 6x 2x 4x 2x 2x

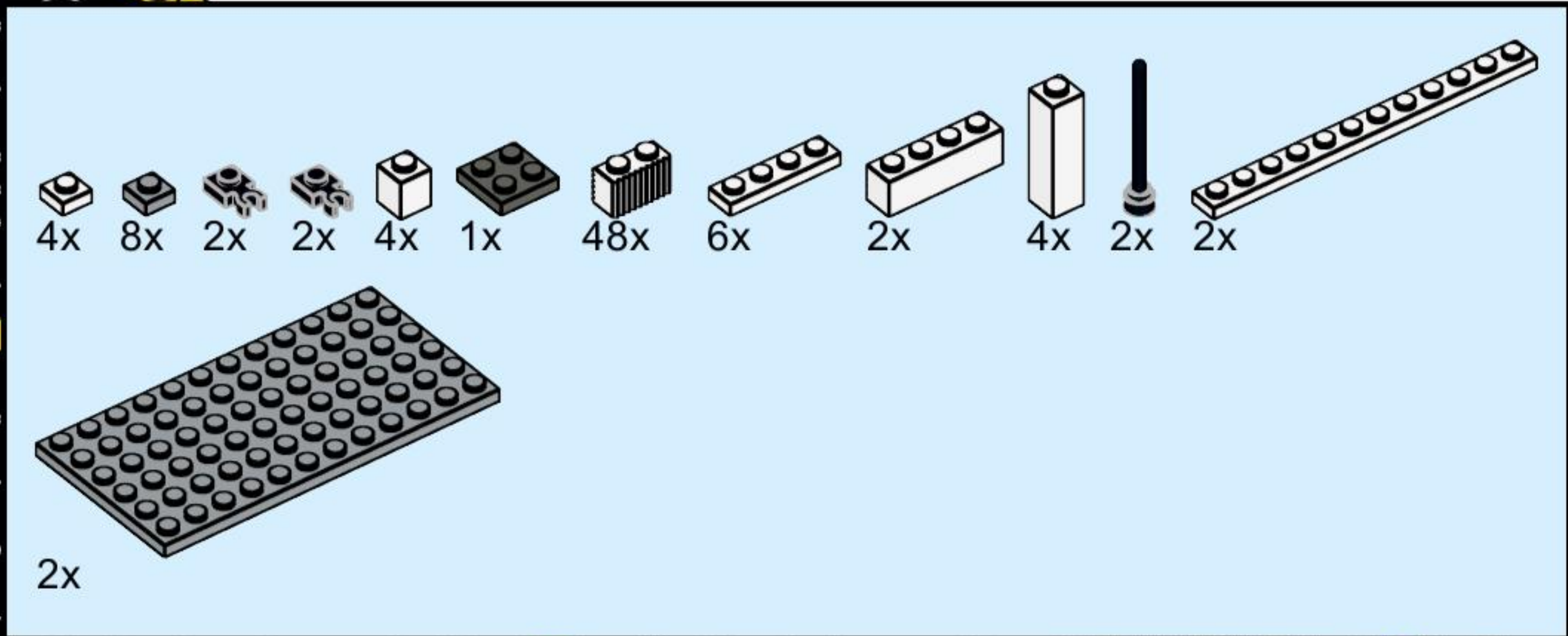

2x

This block contains a parts list and a visual of the required parts. The parts list includes: 4x 1x1 white Technic brick with hole, 8x 1x1 white Technic brick with hole, 2x 1x2 grey Technic axle pin with hole, 2x 1x2 grey Technic axle pin with hole, 4x 1x1 white Technic brick with hole, 1x 1x2 grey Technic brick with hole, 48x 1x2 grey Technic axle pin, 6x 1x3 white Technic axle pin, 2x 1x4 white Technic axle pin, 4x 1x4 white Technic axle pin, 2x 1x4 black Technic axle pin, and 2x 1x12 grey Technic axle pin. Below the list is a visual of two 1x12 grey Technic axle pins, with the quantity '2x' written below them.

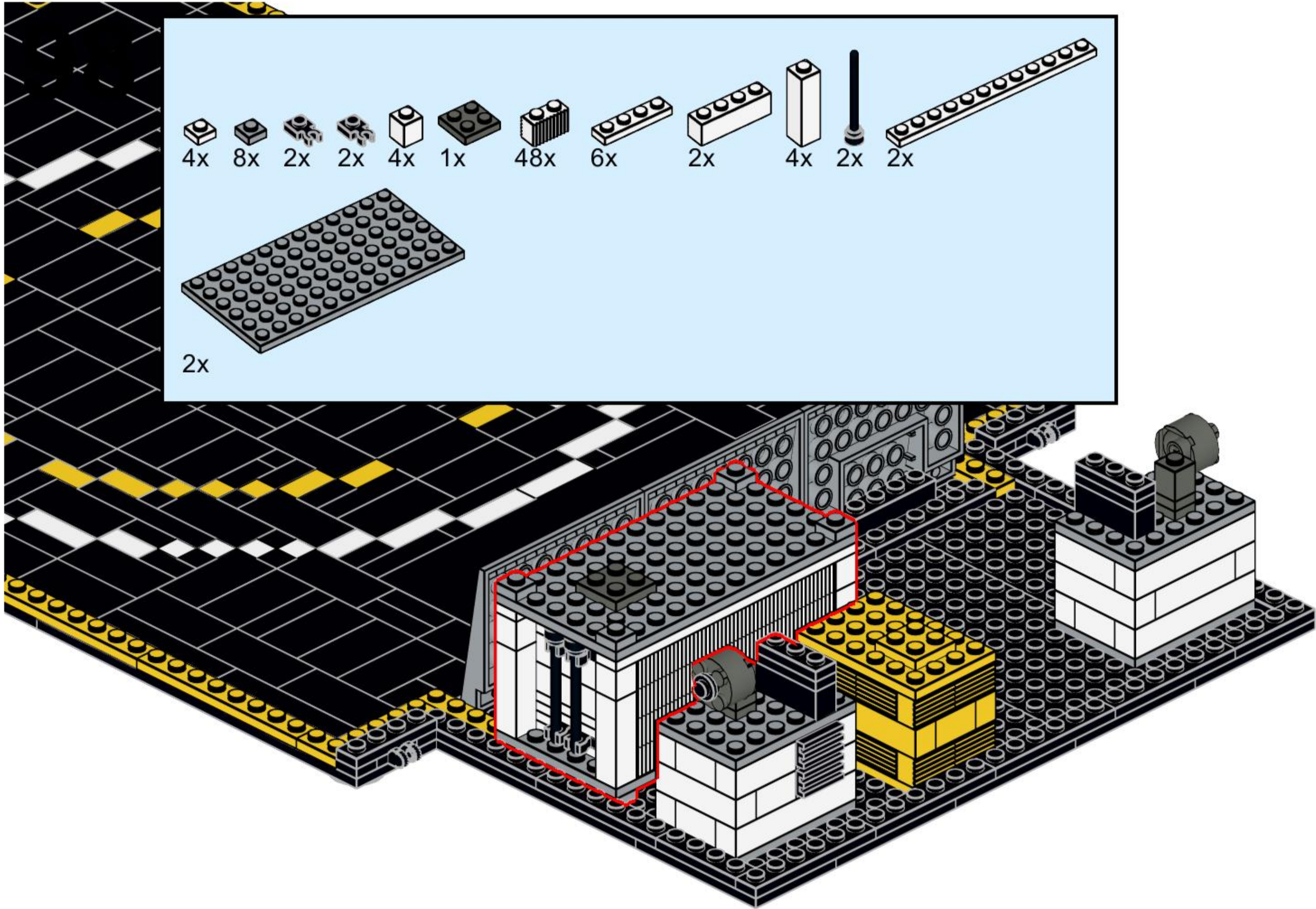

99



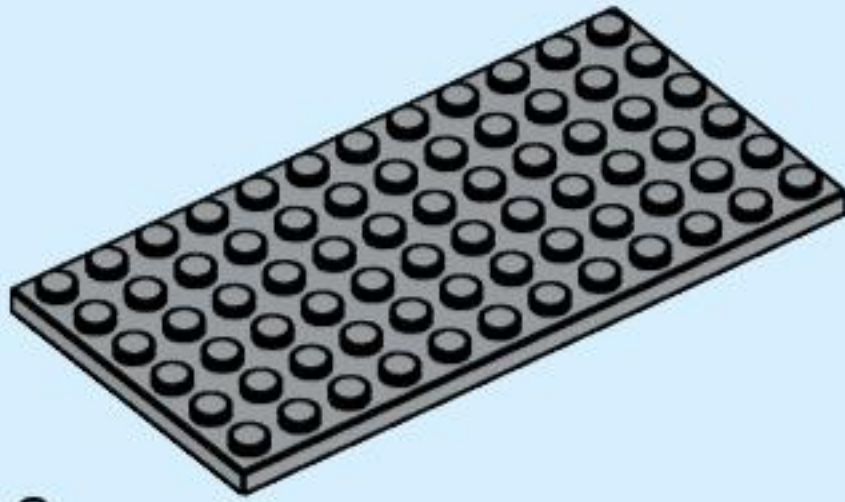

- 1x 
- 1x 
- 4x 
- 8x 
- 2x 
- 2x 
- 4x 
- 1x 
- 2x 
- 48x 
- 6x 
- 2x 
- 3x 
- 4x 
- 2x 
- 2x 

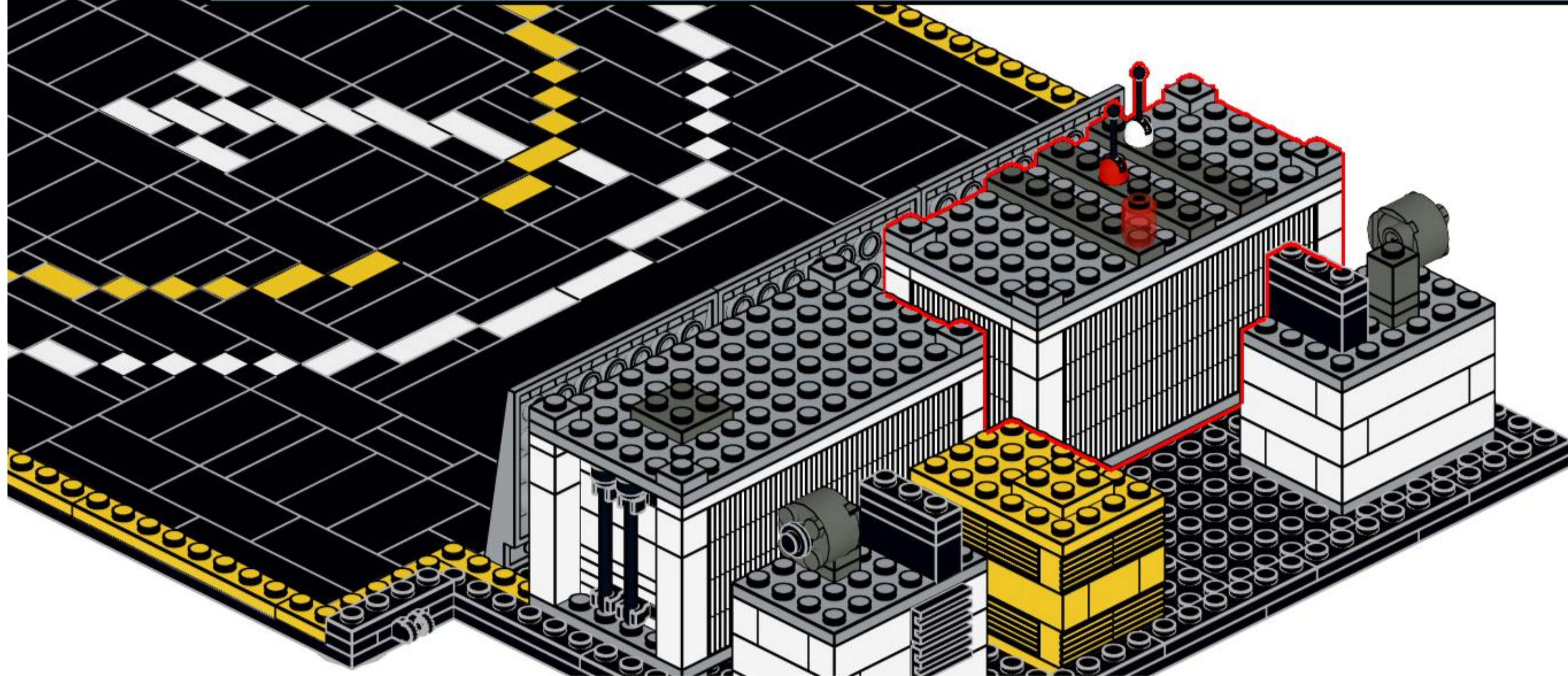

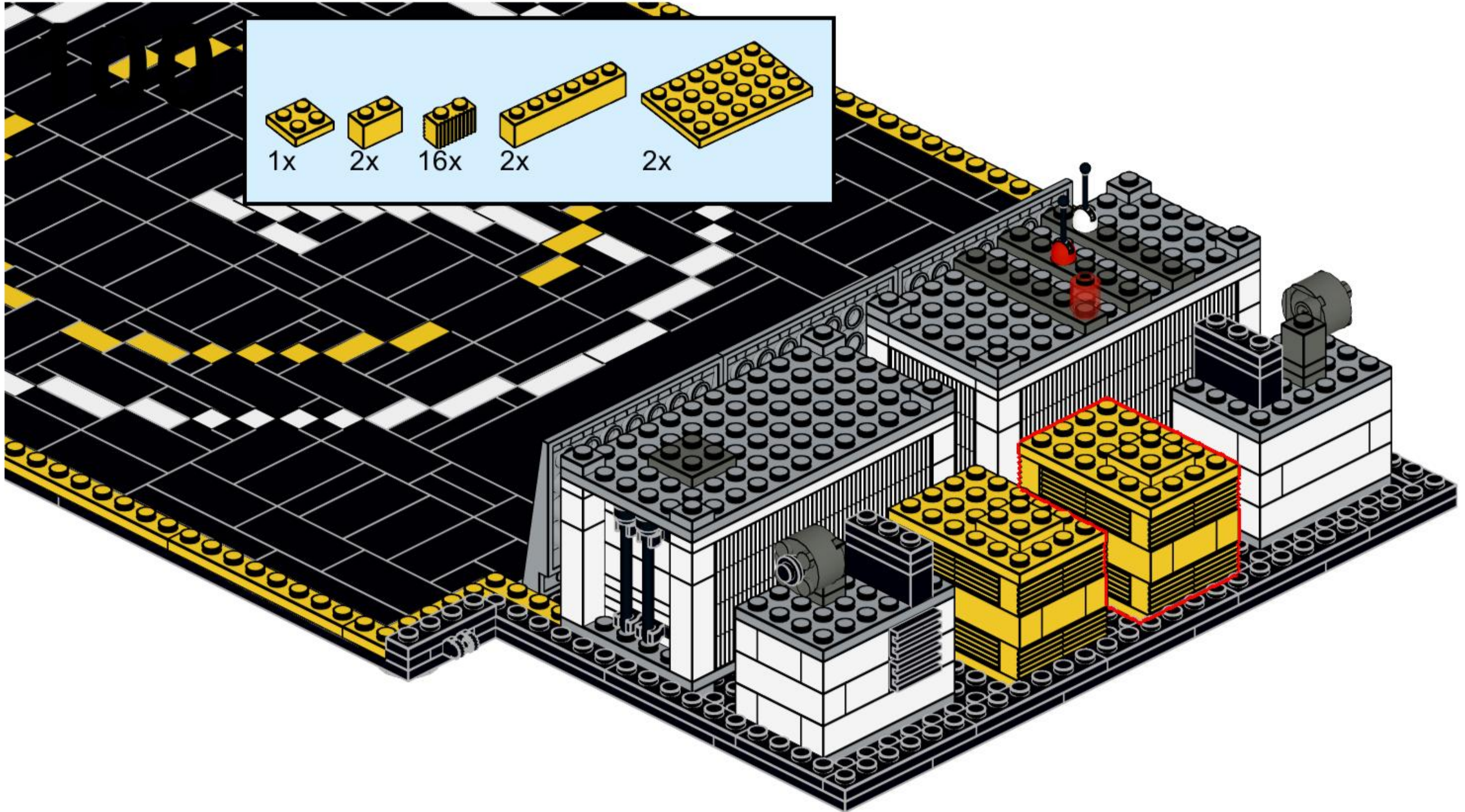
2x



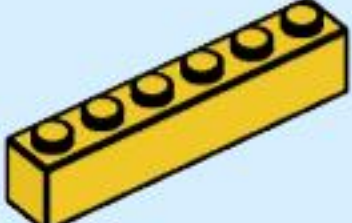

- 1x 
- 2x 
- 16x 
- 2x 
- 2x 

101

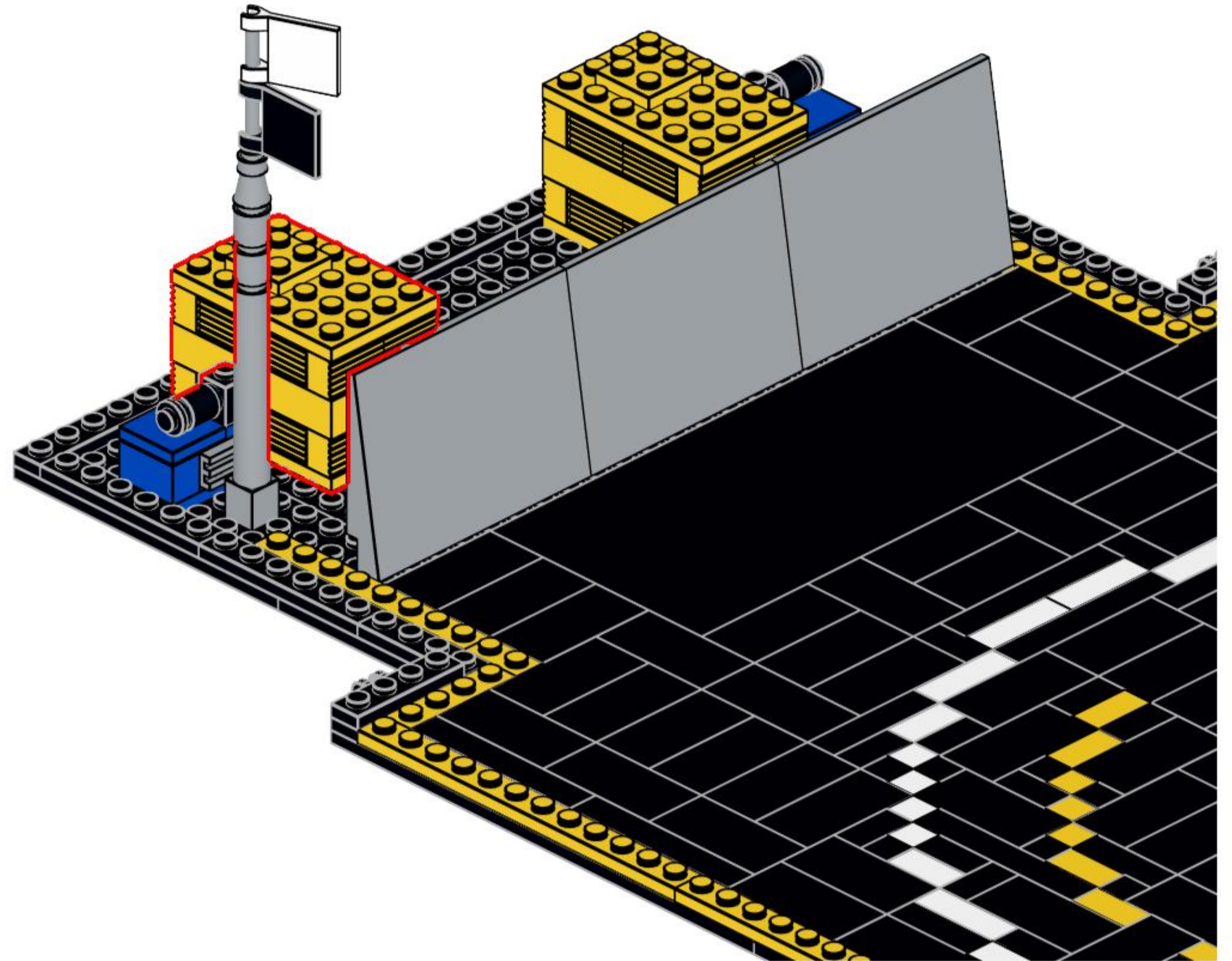
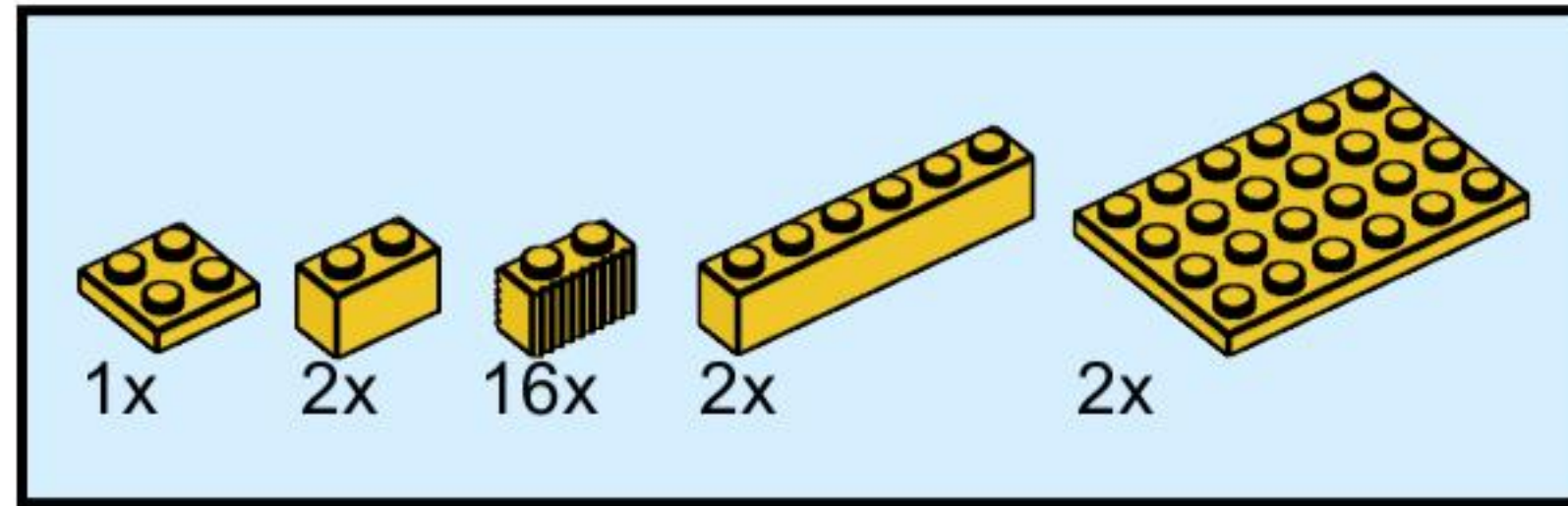

102

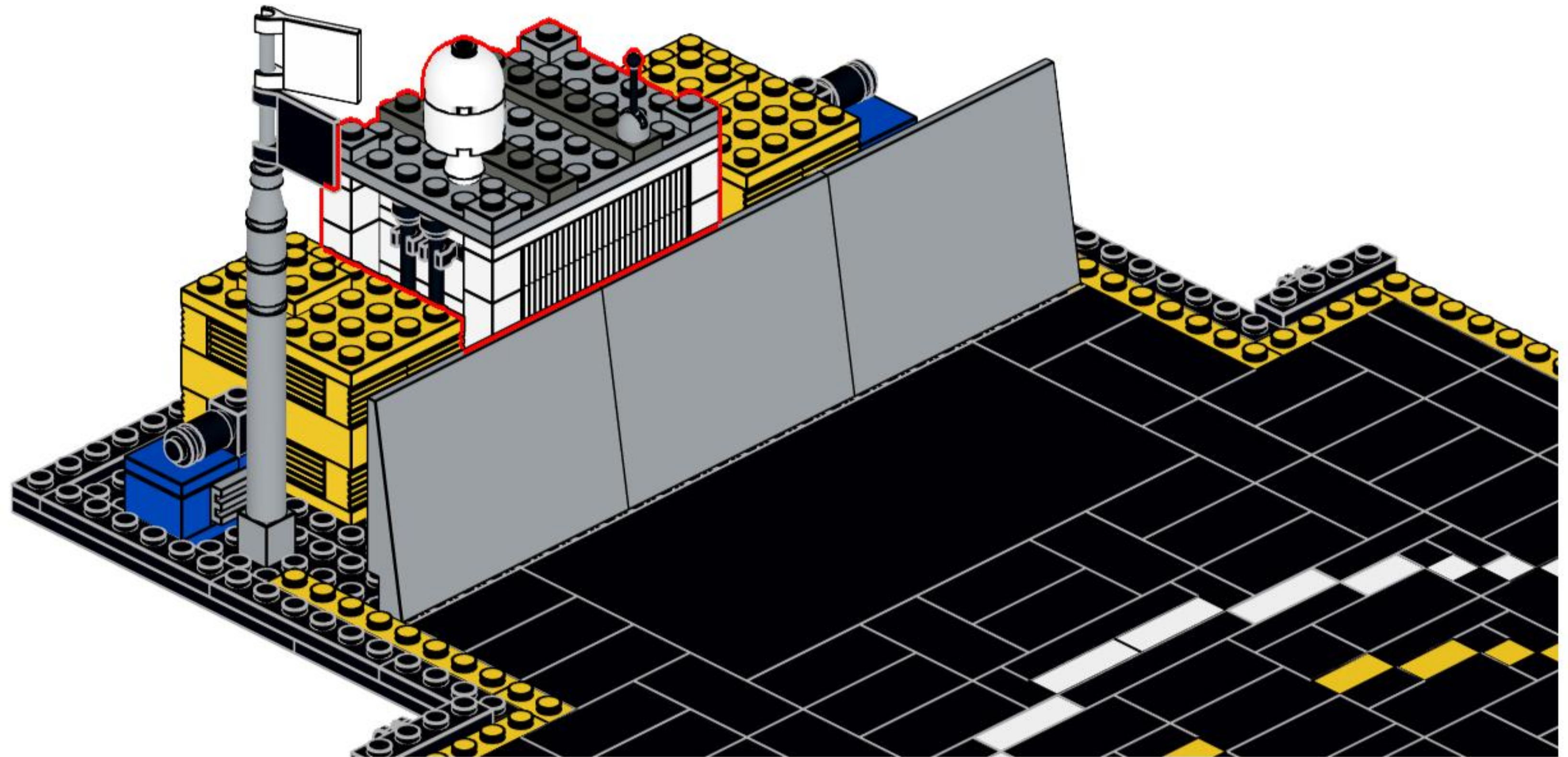
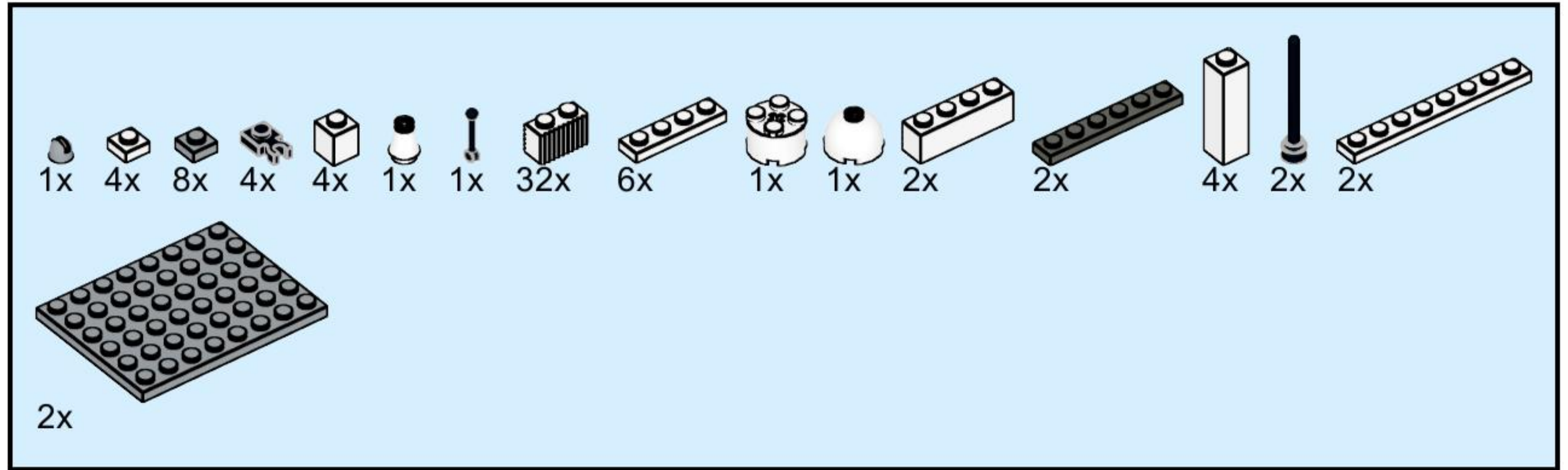

- 2x
- 1x
- 2x
- 1x
- 1x
- 1x
- 2x
- 1x

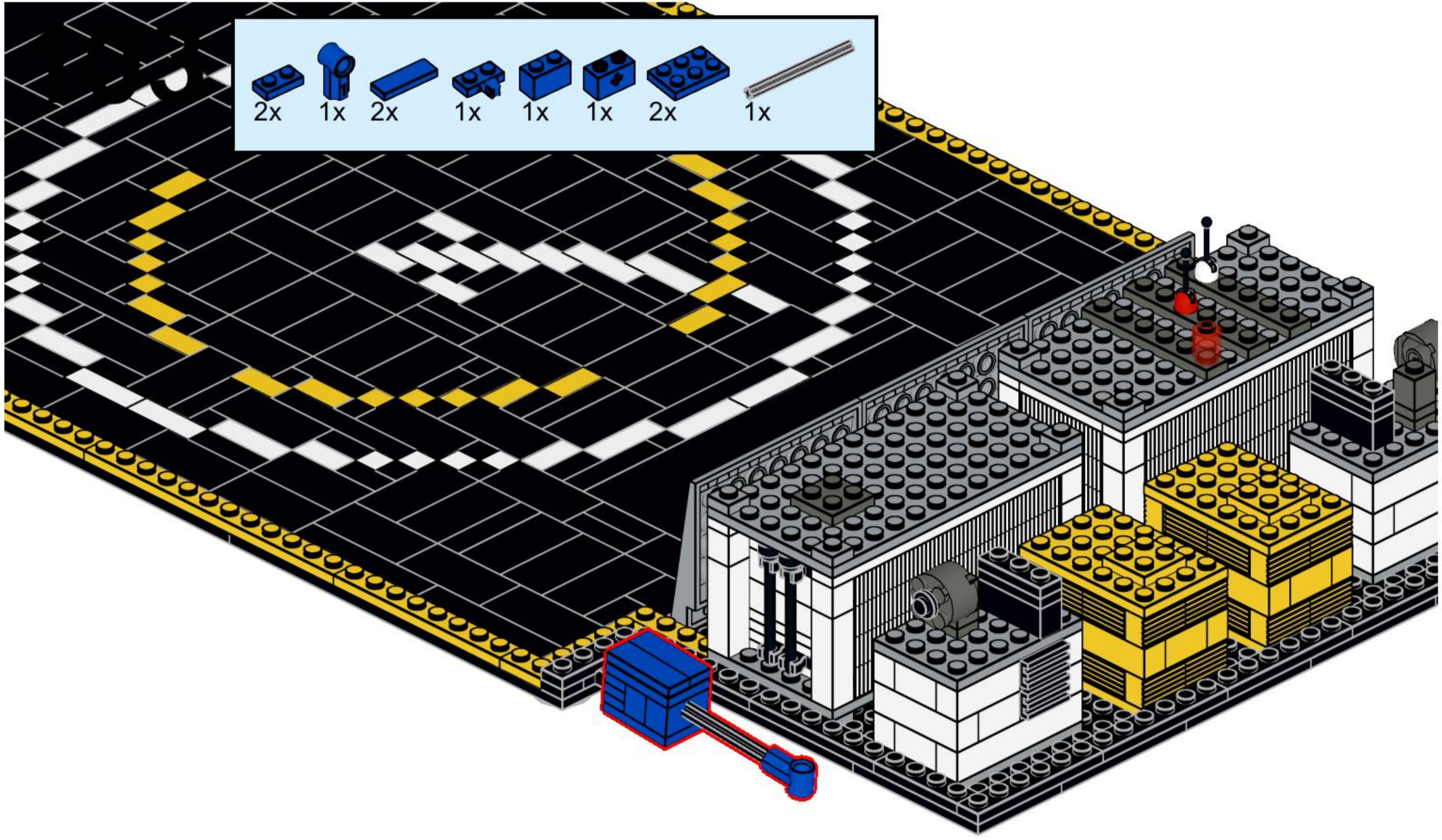



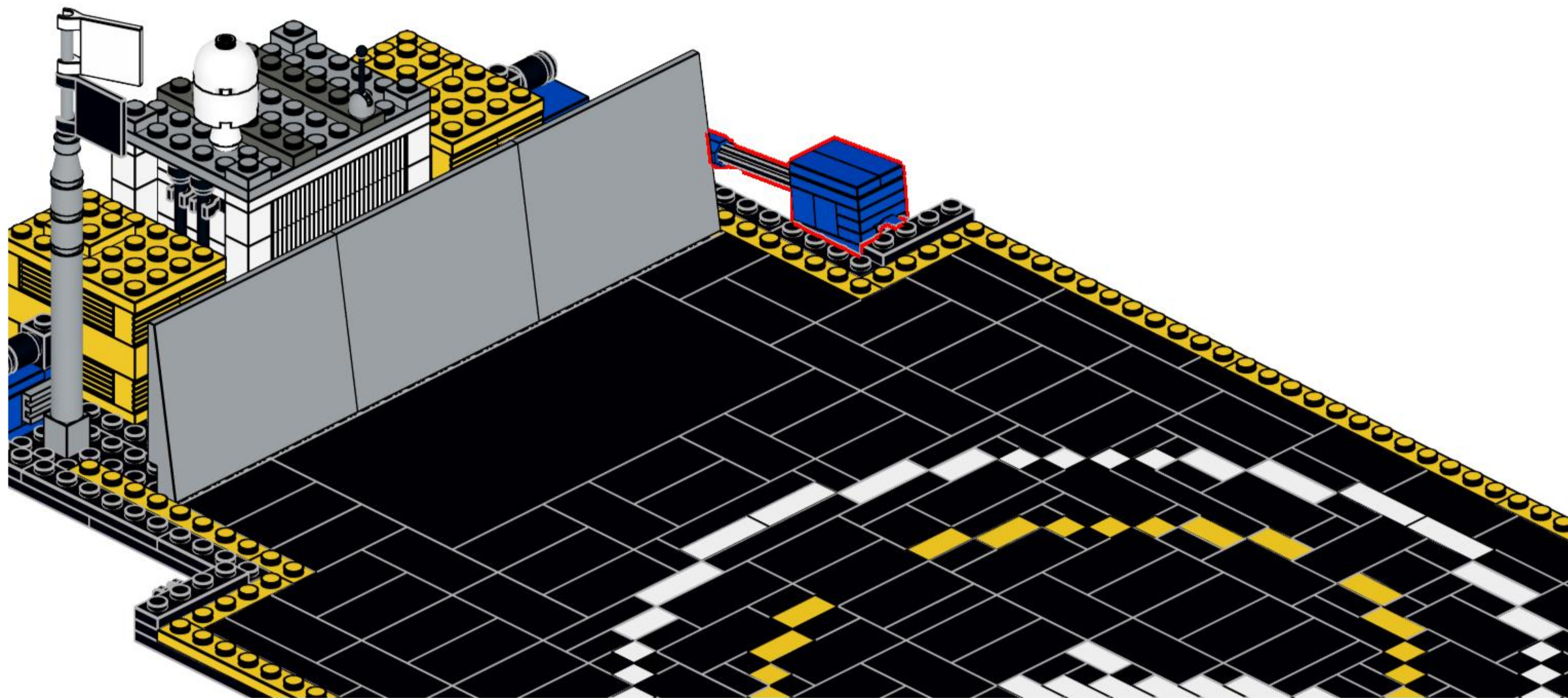
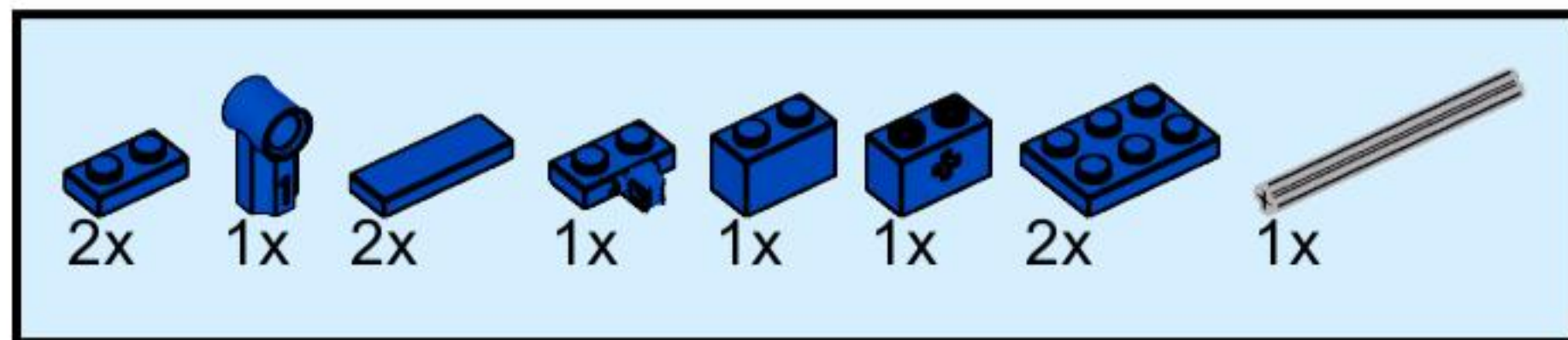



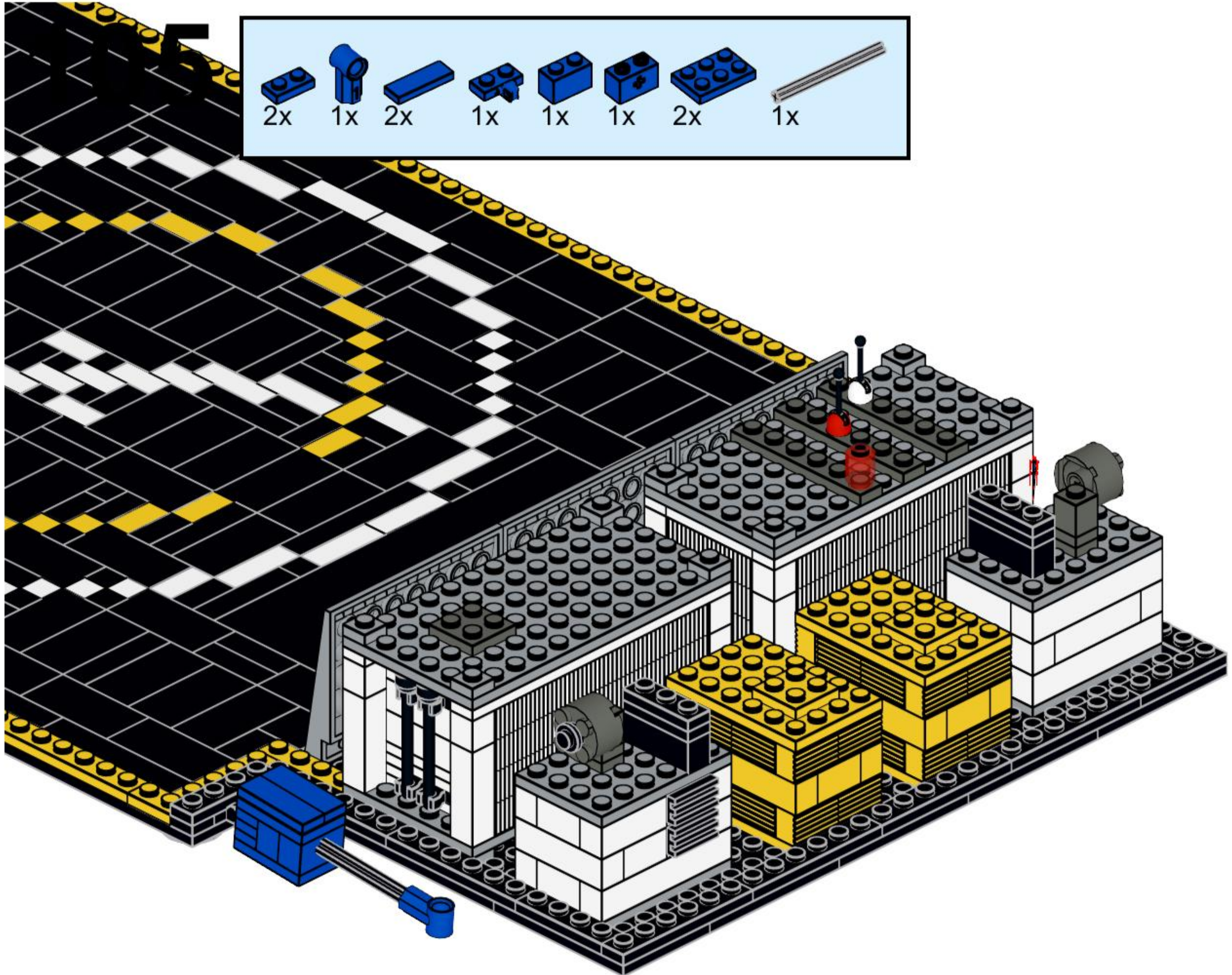

104



2x 1x 2x 1x 1x 1x 2x 1x



106

								
2x	1x	2x	1x	1x	1x	3x	2x	1x

